

第13章 二端口网络

本章重点

13.1	二端口网络
13.2	二端口的方程和参数
13.3	二端口的等效电路
13.4	二端口的转移函数
13.5	二端口的连接
13.6	回转器和负阻抗转换器

● 重点

1. 两端口的参数和方程
2. 两端口的等效电路
3. 两端口的转移函数

13.1 二端口网络

在工程实际中，研究信号及能量的传输和信号变换时，经常碰到如下两端口电路。

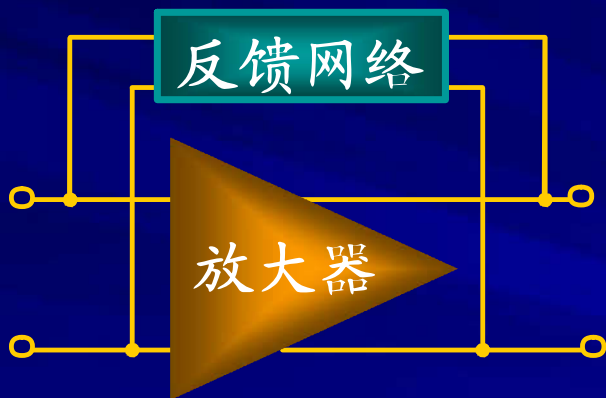

放大器

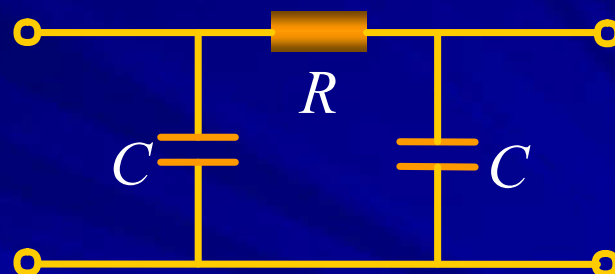

滤波器

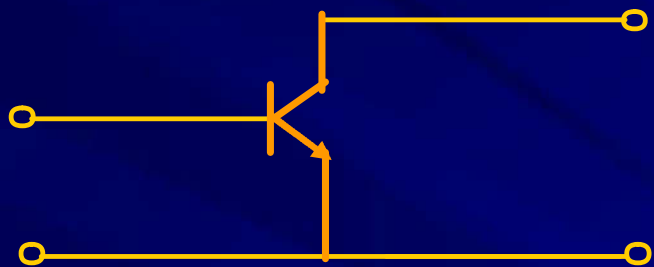

三极管



传输线

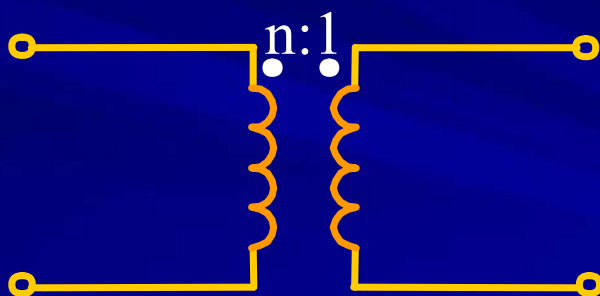

变压器

1. 端口

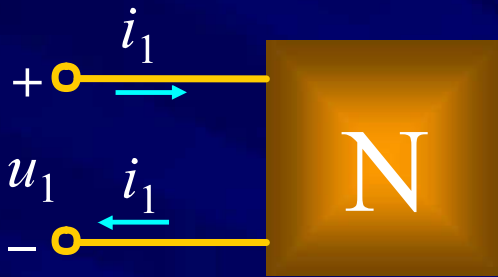

端口由一对端钮构成，且满足如下端口条件：从一个端钮流入的电流等于从另一个端钮流出的电流。

2. 二端口

当一个电路与外部电路通过两个端口连接时称此电路为二端口网络。

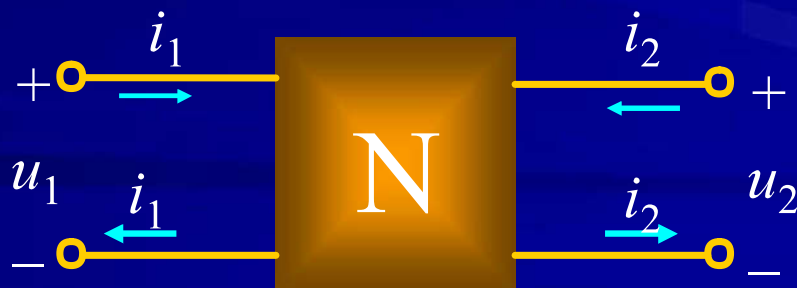



注意 ①二端口网络与四端网络的关系

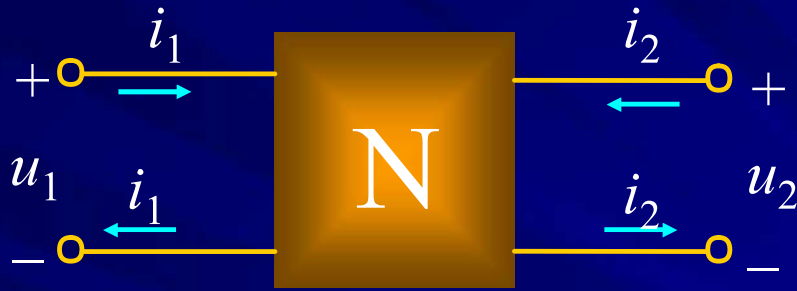

二端口

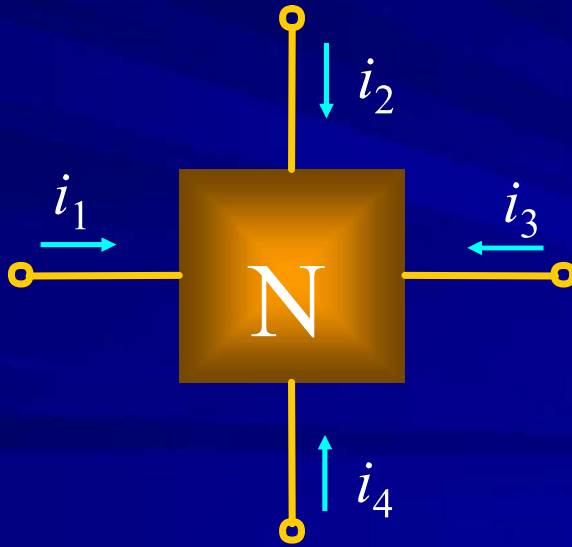

四端网络

② 二端口的两个端口间若有外部连接，则会破坏原二端口的端口条件。

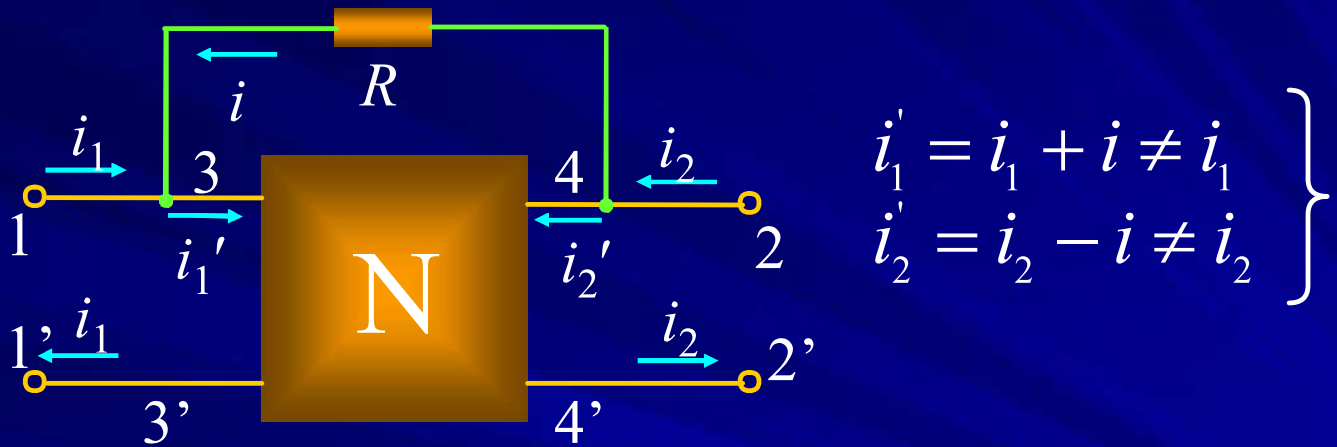

1-1' 2-2' 是二端口

3-3' 4-4' 不是二端口，是四端网络

3. 研究二端口网络的意义

- ① 两端口的分析方法易推广应用于 n 端口网络;
- ② 大网络可以分割成许多子网络(二端口)进行分析;
- ③ 仅研究端口特性时,可以用二端口网络的电路模型进行研究。

4. 分析方法

- ① 分析前提: 讨论初始条件为零的线性无源二端口网络;
- ② 找出两个端口的电压、电流关系的独立网络方程, 这些方程通过一些参数来表示。

13.2 二端口的方程和参数



约定

1. 讨论范围:

线性 R 、 L 、 C 、 M 与线性受控源，
不含独立源。

2. 端口电压、电流的参考方向如图





注意 端口物理量4个 $\rightarrow i_1 \ i_2 \ u_1 \ u_2$

端口电压电流有六种不同的方程来表示，
即可用六套参数描述二端口网络。

$$\begin{array}{ccc}
 i_1 & \Leftrightarrow & u_1 \\
 i_2 & \Leftrightarrow & u_2 \\
 u_1 & \Leftrightarrow & u_2 \\
 i_1 & \Leftrightarrow & i_2 \\
 u_1 & \Leftrightarrow & i_1 \\
 i_2 & \Leftrightarrow & u_2
 \end{array}$$

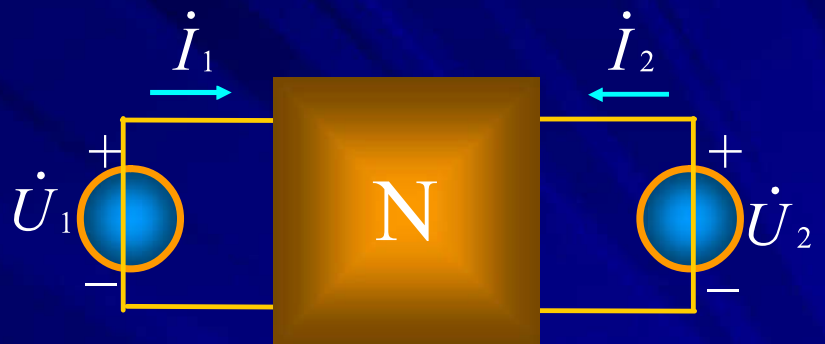
1. Y 参数和方程① Y 参数方程

采用相量形式(正弦稳态)。将两个端口各施加一电压源,则端口电流可视为电压源单独作用时产生的电流之和。

即:

$$\begin{cases} \dot{I}_1 = Y_{11}\dot{U}_1 + Y_{12}\dot{U}_2 \\ \dot{I}_2 = Y_{21}\dot{U}_1 + Y_{22}\dot{U}_2 \end{cases}$$

Y 参数方程

写成矩阵形式为：

Y 参数矩阵

$$\begin{bmatrix} \dot{I}_1 \\ \dot{I}_2 \end{bmatrix} = \begin{bmatrix} Y_{11} & Y_{12} \\ Y_{21} & Y_{22} \end{bmatrix} \begin{bmatrix} \dot{U}_1 \\ \dot{U}_2 \end{bmatrix} \quad [Y] = \begin{bmatrix} Y_{11} & Y_{12} \\ Y_{21} & Y_{22} \end{bmatrix}$$



注意 Y参数值由内部元件参数及连接关系决定。

② Y参数的物理意义及计算和测定

$$Y_{11} = \left. \frac{\dot{I}_1}{\dot{U}_1} \right|_{\dot{U}_2=0} \quad \text{输入导纳}$$

$$Y_{21} = \left. \frac{\dot{I}_2}{\dot{U}_1} \right|_{\dot{U}_2=0} \quad \text{转移导纳}$$

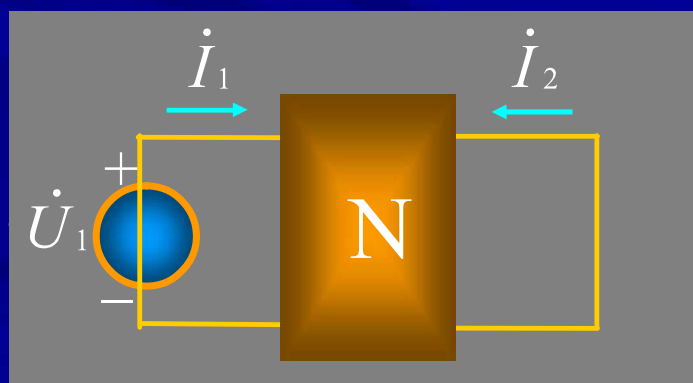

返回

上页

下页

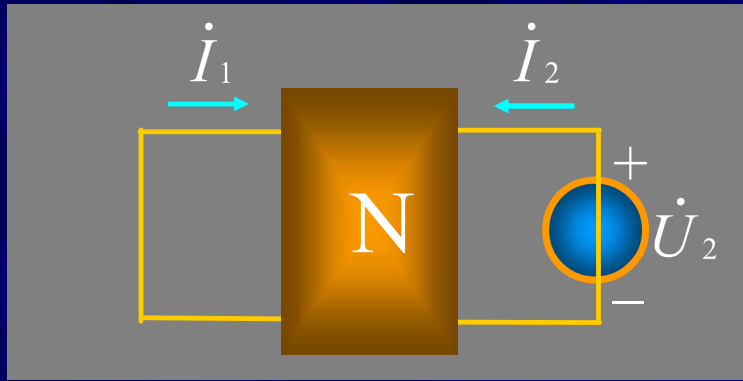

$$Y_{12} = \frac{\dot{I}_1}{\dot{U}_2} \Big|_{\dot{U}_1=0} \quad \text{转移导纳}$$

$$Y_{22} = \frac{\dot{I}_2}{\dot{U}_2} \Big|_{\dot{U}_1=0} \quad \text{输入导纳}$$

$Y \rightarrow$ 短路导纳参数

例1 求图示两端口的 Y 参数。

解

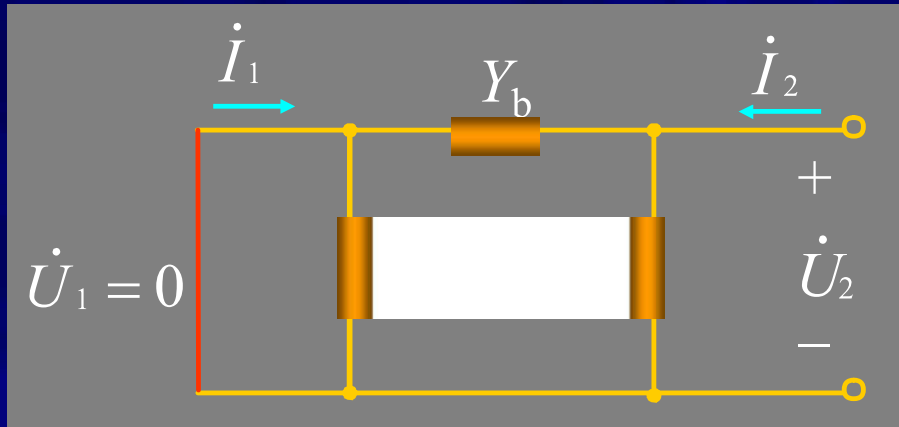

$$Y_{11} = \left. \frac{\dot{I}_1}{\dot{U}_1} \right|_{\dot{U}_2=0} = Y_a + Y_b \quad Y_{12} = \left. \frac{\dot{I}_1}{\dot{U}_2} \right|_{\dot{U}_1=0} = -Y_b$$

$$Y_{21} = \left. \frac{\dot{I}_2}{\dot{U}_1} \right|_{\dot{U}_2=0} = -Y_b \quad Y_{22} = \left. \frac{\dot{I}_2}{\dot{U}_2} \right|_{\dot{U}_1=0} = Y_b + Y_c$$

例2 求两端口的Y参数。

解 直接列方程求解

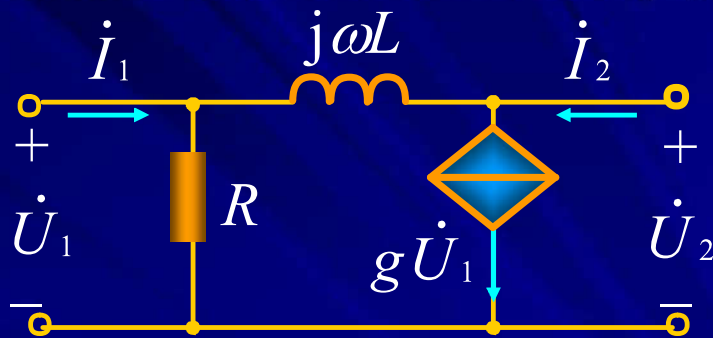

$$\dot{I}_1 = \frac{\dot{U}_1}{R} + \frac{\dot{U}_1 - \dot{U}_2}{j\omega L} = \left(\frac{1}{R} + \frac{1}{j\omega L}\right)\dot{U}_1 - \frac{1}{j\omega L}\dot{U}_2$$

$$\dot{I}_2 = g\dot{U}_1 + \frac{\dot{U}_2 - \dot{U}_1}{j\omega L} = \left(g - \frac{1}{j\omega L}\right)\dot{U}_1 + \frac{1}{j\omega L}\dot{U}_2$$

$$[Y] = \begin{bmatrix} \frac{1}{R} + \frac{1}{j\omega L} & -\frac{1}{j\omega L} \\ g - \frac{1}{j\omega L} & \frac{1}{j\omega L} \end{bmatrix}$$

$$g = 0 \rightarrow$$

$$Y_{12} = Y_{21} = -\frac{1}{j\omega L}$$

③ 互易二端口 (满足互易定理)

$$Y_{12} = \frac{\dot{I}_1}{\dot{U}_2} \Big|_{\dot{U}_1=0} \quad Y_{21} = \frac{\dot{I}_2}{\dot{U}_1} \Big|_{\dot{U}_2=0}$$

当 $\dot{U}_1 = \dot{U}_2$ 时, $\dot{I}_1 = \dot{I}_2$

→ $Y_{12} = Y_{21}$

上例中有 $Y_{12} = Y_{21} = -Y_b$



注意 互易二端口四个参数中只有三个是独立的。

④ 对称二端口

对称二端口 除 $Y_{12} = Y_{21}$ 外, 还满足 $Y_{11} = Y_{22}$,

上例中, $Y_a = Y_c = Y$ 时, $Y_{11} = Y_{22} = Y + Y_b$



注意 对称二端口只有两个参数是独立的。

对称二端口是指两个端口电气特性上对称。电路结构左右对称的一般为对称二端口。结构不对称的二端口, 其电气特性可能是对称的, 这样的二端口也是对称二端口。

例 求图示两端口的Y参数。

为互易对称两端口

解

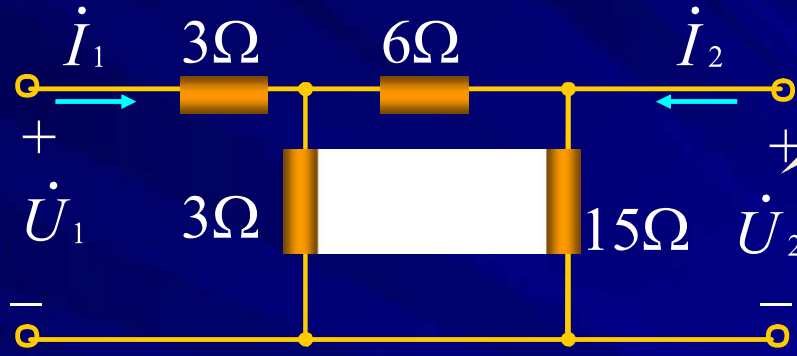

$$Y_{11} = \frac{\dot{I}_1}{\dot{U}_1} \Big|_{\dot{U}_2=0} = \frac{1}{3//6+3} = 0.2S \quad \color{red}{=} \quad Y_{22} = \frac{\dot{I}_2}{\dot{U}_2} \Big|_{\dot{U}_1=0} = 0.2S$$

$$Y_{21} = \frac{\dot{I}_2}{\dot{U}_1} \Big|_{\dot{U}_2=0} = -0.0667S \quad \color{red}{=} \quad Y_{12} = \frac{\dot{I}_1}{\dot{U}_2} \Big|_{\dot{U}_1=0} = -0.0667S$$

2. Z 参数和方程

① Z 参数方程

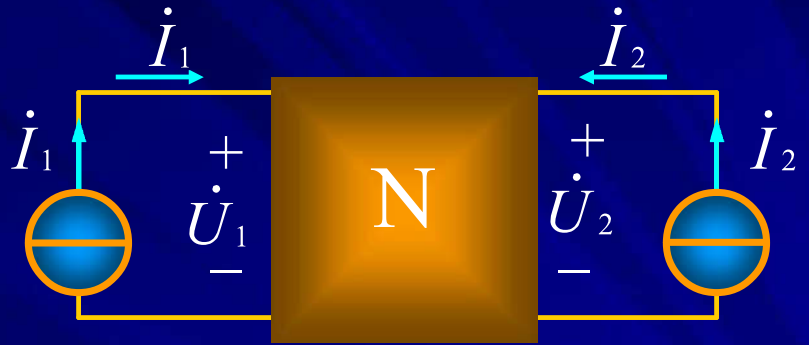

将两个端口各施加一电流源，则端口电压可视为电流源单独作用时产生的电压之和。

即：

$$\begin{cases} \dot{U}_1 = Z_{11}\dot{I}_1 + Z_{12}\dot{I}_2 \\ \dot{U}_2 = Z_{21}\dot{I}_1 + Z_{22}\dot{I}_2 \end{cases}$$

Z 参数方程

也可由 Y 参数方程
$$\begin{cases} \dot{I}_1 = Y_{11}\dot{U}_1 + Y_{12}\dot{U}_2 \\ \dot{I}_2 = Y_{21}\dot{U}_1 + Y_{22}\dot{U}_2 \end{cases}$$
 解出 \dot{U}_1, \dot{U}_2 .

即:
$$\begin{cases} \dot{U}_1 = \frac{Y_{22}}{\Delta} \dot{I}_1 + \frac{-Y_{12}}{\Delta} \dot{I}_2 = Z_{11}\dot{I}_1 + Z_{12}\dot{I}_2 \\ \dot{U}_2 = \frac{-Y_{21}}{\Delta} \dot{I}_1 + \frac{Y_{11}}{\Delta} \dot{I}_2 = Z_{21}\dot{I}_1 + Z_{22}\dot{I}_2 \end{cases}$$

得到 Z 参数方程。其中 $\Delta = Y_{11}Y_{22} - Y_{12}Y_{21}$

其矩阵形式为:

$$\begin{bmatrix} \dot{U}_1 \\ \dot{U}_2 \end{bmatrix} = \begin{bmatrix} Z_{11} & Z_{12} \\ Z_{21} & Z_{22} \end{bmatrix} \begin{bmatrix} \dot{I}_1 \\ \dot{I}_2 \end{bmatrix} = [Z] \begin{bmatrix} \dot{I}_1 \\ \dot{I}_2 \end{bmatrix}$$

$$[Z] = \begin{bmatrix} Z_{11} & Z_{12} \\ Z_{21} & Z_{22} \end{bmatrix}$$

Z 参数矩阵

$$[Z] = [Y]^{-1}$$

② Z 参数的物理意义及计算和测定

$$Z_{11} = \left. \frac{\dot{U}_1}{\dot{I}_1} \right|_{i_2=0} \quad \text{输入阻抗}$$

$$Z_{21} = \left. \frac{\dot{U}_2}{\dot{I}_1} \right|_{i_2=0} \quad \text{转移阻抗}$$

$$Z_{12} = \left. \frac{\dot{U}_1}{\dot{I}_2} \right|_{i_1=0} \quad \text{转移阻抗}$$

$$Z_{22} = \left. \frac{\dot{U}_2}{\dot{I}_2} \right|_{i_1=0} \quad \text{输入阻抗}$$

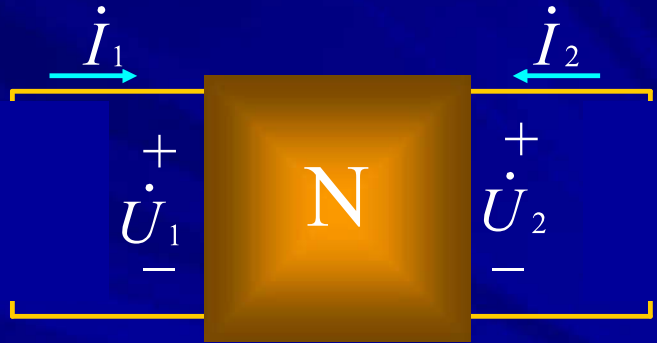

Z → 开路阻抗参数

③ 互易性和对称性

互易二端口满足: $Z_{12} = Z_{21}$

对称二端口满足: $Z_{11} = Z_{22}$

例1 求图示两端口的Z参数。

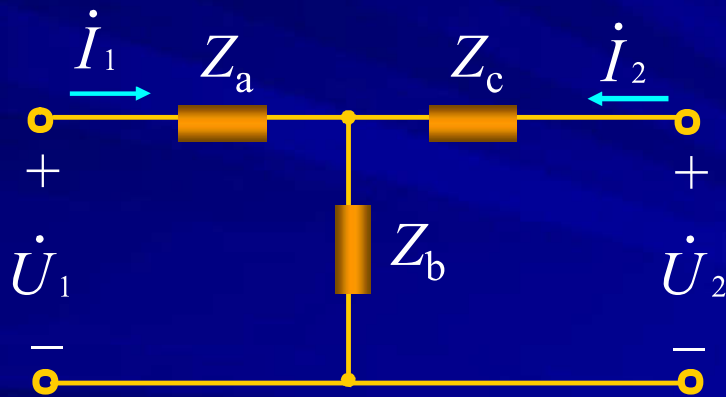

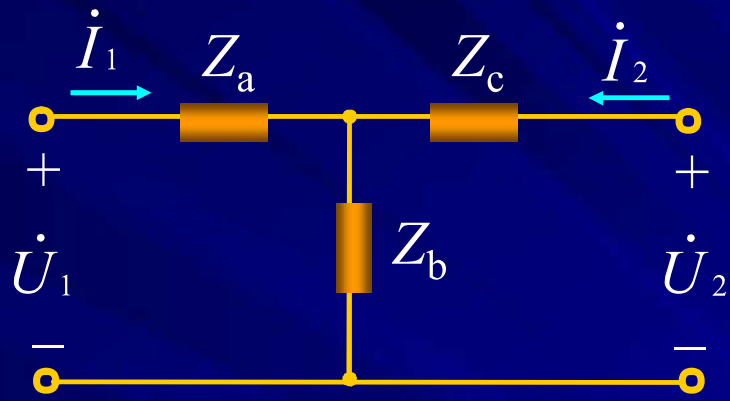

解法1

$$Z_{11} = \frac{\dot{U}_1}{\dot{I}_1} \Big|_{\dot{I}_2=0} = Z_a + Z_b$$

$$Z_{12} = \frac{\dot{U}_1}{\dot{I}_2} \Big|_{\dot{I}_1=0} = Z_b$$

$$Z_{21} = \frac{\dot{U}_2}{\dot{I}_1} \Big|_{\dot{I}_2=0} = Z_b$$

$$Z_{22} = \frac{\dot{U}_2}{\dot{I}_2} \Big|_{\dot{I}_1=0} = Z_b + Z_c$$

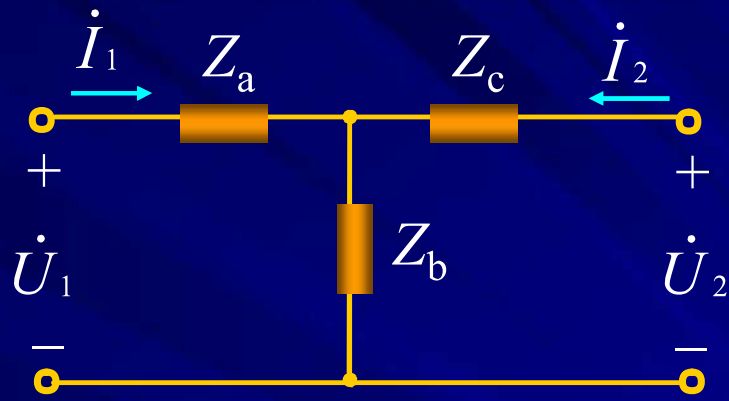

解法2 列KVL方程:

$$\dot{U}_1 = Z_a \dot{I}_1 + Z_b (\dot{I}_1 + \dot{I}_2) = (Z_a + Z_b) \dot{I}_1 + Z_b \dot{I}_2$$

$$\dot{U}_2 = Z_c \dot{I}_2 + Z_b (\dot{I}_1 + \dot{I}_2) = Z_b \dot{I}_1 + (Z_b + Z_c) \dot{I}_2$$

$$[\mathbf{Z}] = \begin{bmatrix} Z_a + Z_b & Z_b \\ Z_b & Z_b + Z_c \end{bmatrix}$$

例2 求图示两端口的Z参数。

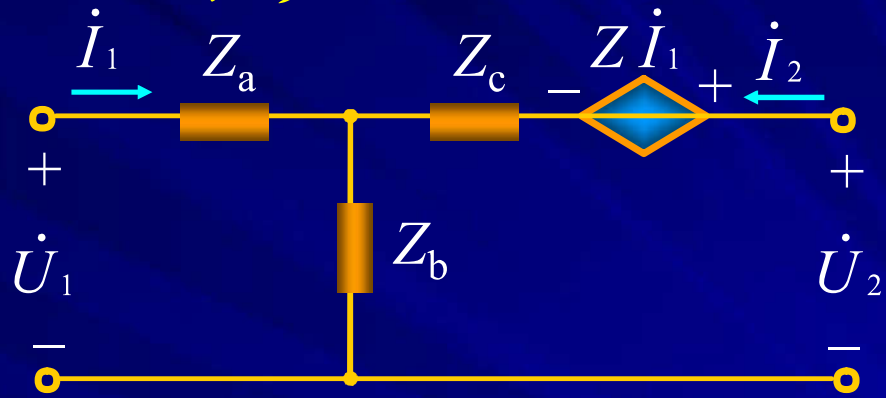

解

列KVL方程：

$$\dot{U}_1 = Z_a \dot{I}_1 + Z_b (\dot{I}_1 + \dot{I}_2) = (Z_a + Z_b) \dot{I}_1 + Z_b \dot{I}_2$$

$$\begin{aligned} \dot{U}_2 &= Z_c \dot{I}_2 + Z_b (\dot{I}_1 + \dot{I}_2) + Z \dot{I}_1 \\ &= (Z_b + Z) \dot{I}_1 + (Z_b + Z_c) \dot{I}_2 \end{aligned}$$

$$\rightarrow [Z] = \begin{bmatrix} Z_a + Z_b & Z_b \\ Z_b + Z & Z_b + Z_c \end{bmatrix}$$

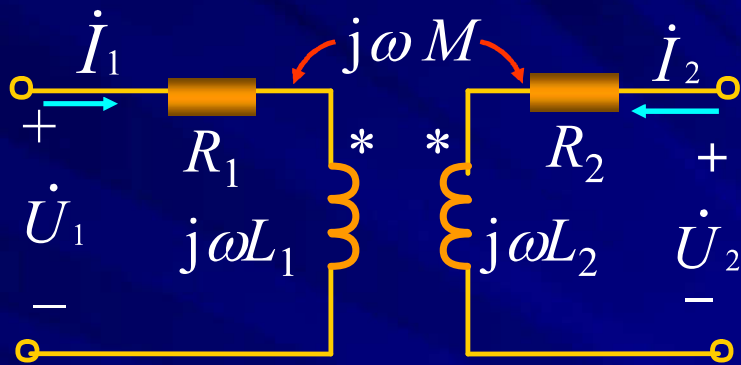
例3 求两端口 Z 、 Y 参数

解

$$[Y] = [Z]^{-1} = \frac{\begin{bmatrix} R_2 + j\omega L_2 & -j\omega M \\ -j\omega M & R_1 + j\omega L_1 \end{bmatrix}}{\begin{vmatrix} R_1 + j\omega L_1 & j\omega M \\ j\omega M & R_2 + j\omega L_2 \end{vmatrix}}$$



注意 并非所有的二端口均有 Z 、 Y 参数。

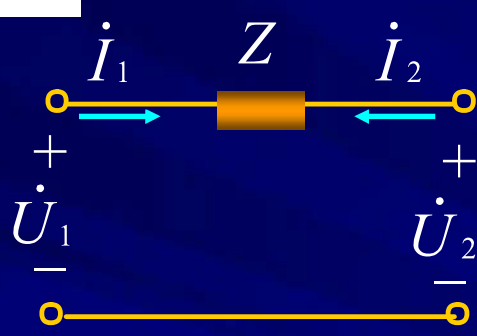

$$I_1 = -I_2 = \frac{U_1 - U_2}{Z}$$

$$[Z] = [Y]^{-1}$$

不存在

$$[Y] = \begin{bmatrix} \frac{1}{Z} & -\frac{1}{Z} \\ -\frac{1}{Z} & \frac{1}{Z} \end{bmatrix}$$

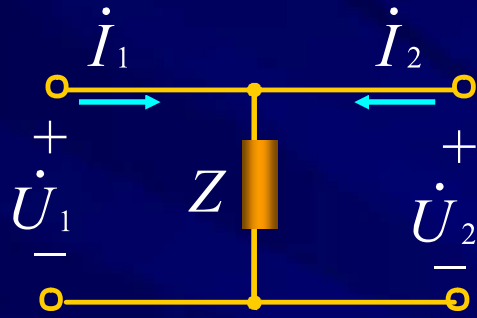

$$\dot{U}_1 = \dot{U}_2 = Z(\dot{I}_1 + \dot{I}_2)$$

$$\rightarrow [Z] = \begin{bmatrix} Z & Z \\ Z & Z \end{bmatrix}$$

$$[Y] = [Z]^{-1} \quad \text{不存在}$$

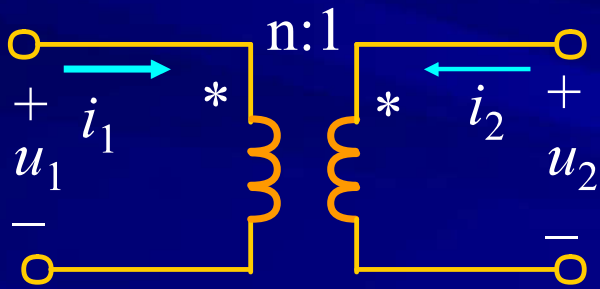

$$\dot{U}_1 = n\dot{U}_2$$

$$\dot{I}_1 = -\dot{I}_2 / n$$

$$[Y] \quad [Z] \quad \text{均不存在}$$

3. T 参数和方程① T 参数和方程

定义:
$$\begin{cases} \dot{U}_1 = A\dot{U}_2 - B\dot{I}_2 \\ \dot{I}_1 = C\dot{U}_2 - D\dot{I}_2 \end{cases}$$

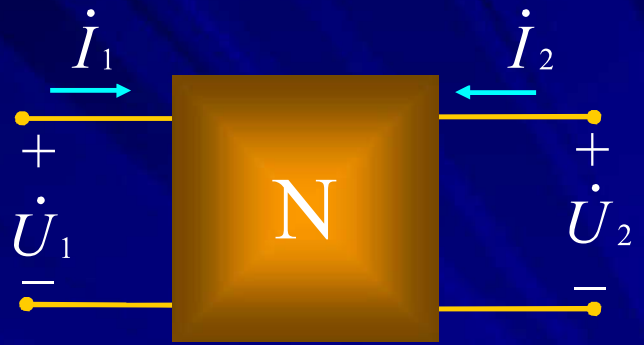

$$\rightarrow \begin{bmatrix} \dot{U}_1 \\ \dot{I}_1 \end{bmatrix} = [T] \begin{bmatrix} \dot{U}_2 \\ -\dot{I}_2 \end{bmatrix} \quad [T] = \begin{bmatrix} A & B \\ C & D \end{bmatrix}$$

注意负号

 T 参数矩阵

注意 T 参数也称为传输参数, 反映输入和输出之间的关系。

② T 参数的物理意义及计算和测定

$$A = \left. \frac{\dot{U}_1}{\dot{U}_2} \right|_{i_2=0} \quad \left. \begin{array}{l} \text{转移电压比} \\ \text{开路参数} \end{array} \right\}$$

$$C = \left. \frac{\dot{I}_1}{\dot{U}_2} \right|_{i_2=0} \quad \left. \begin{array}{l} \text{转移导纳} \end{array} \right\}$$

$$B = \left. \frac{\dot{U}_1}{-\dot{I}_2} \right|_{\dot{U}_2=0} \quad \left. \begin{array}{l} \text{转移阻抗} \\ \text{短路参数} \end{array} \right\}$$

$$D = \left. \frac{\dot{I}_1}{-\dot{I}_2} \right|_{\dot{U}_2=0} \quad \left. \begin{array}{l} \text{转移电流比} \end{array} \right\}$$

$$\begin{cases} \dot{U}_1 = A\dot{U}_2 - B\dot{I}_2 \\ \dot{I}_1 = C\dot{U}_2 - D\dot{I}_2 \end{cases}$$

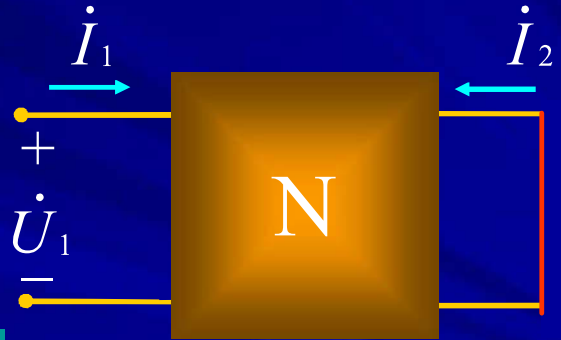

③ 互易性和对称性

Y 参数方程

$$\begin{cases} \dot{I}_1 = Y_{11}\dot{U}_1 + Y_{12}\dot{U}_2 & (1) \\ \dot{I}_2 = Y_{21}\dot{U}_1 + Y_{22}\dot{U}_2 & (2) \end{cases}$$

由 (2) 得:

$$\dot{U}_1 = -\frac{Y_{22}}{Y_{21}}\dot{U}_2 + \frac{1}{Y_{21}}\dot{I}_2 \quad (3)$$

其中

$$\dot{I}_1 = \left(Y_{12} - \frac{Y_{11}Y_{22}}{Y_{21}} \right) \dot{U}_2 + \frac{Y_{11}}{Y_{21}} \dot{I}_2$$

$$A = -\frac{Y_{22}}{Y_{21}} \quad B = \frac{-1}{Y_{21}} \quad C = \frac{Y_{12}Y_{21} - Y_{11}Y_{22}}{Y_{21}} \quad D = -\frac{Y_{11}}{Y_{21}}$$

$$A = -\frac{Y_{22}}{Y_{21}} \quad B = \frac{-1}{Y_{21}} \quad C = \frac{Y_{12}Y_{21} - Y_{11}Y_{22}}{Y_{21}} \quad D = -\frac{Y_{11}}{Y_{21}}$$

互易二端口: $Y_{12} = Y_{21} \rightarrow AD - BC = 1$

对称二端口: $Y_{11} = Y_{22} \rightarrow A = D$

例1
$$\begin{cases} u_1 = nu_2 \\ i_1 = -\frac{1}{n}i_2 \end{cases}$$

即
$$\begin{bmatrix} u_1 \\ i_1 \end{bmatrix} = \begin{bmatrix} n & 0 \\ 0 & \frac{1}{n} \end{bmatrix} \begin{bmatrix} u_2 \\ -i_2 \end{bmatrix}$$

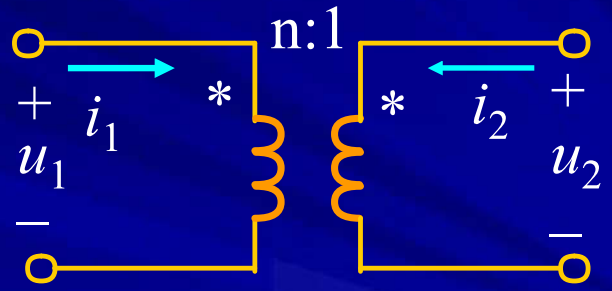

$$\begin{bmatrix} u_1 \\ i_1 \end{bmatrix} = \begin{bmatrix} n & 0 \\ 0 & \frac{1}{n} \end{bmatrix} \begin{bmatrix} u_2 \\ -i_2 \end{bmatrix} \rightarrow [T] = \begin{bmatrix} n & 0 \\ 0 & \frac{1}{n} \end{bmatrix}$$

例2

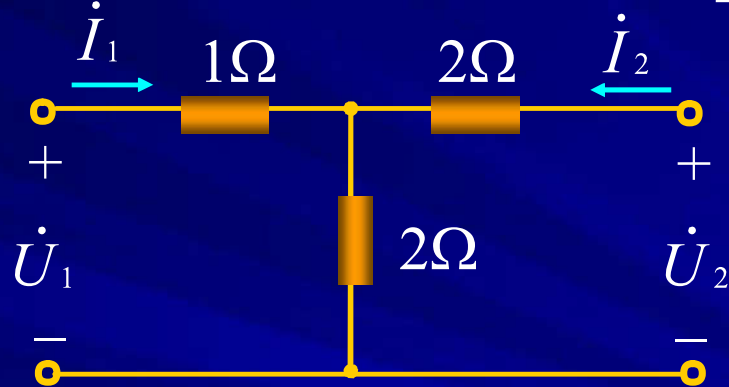

$$A = \left. \frac{U_1}{U_2} \right|_{I_2=0} = 1.5$$

$$C = \left. \frac{I_1}{U_2} \right|_{I_2=0} = 0.5 \text{ S}$$

$$B = \left. \frac{U_1}{-I_2} \right|_{U_2=0} = 4 \Omega$$

$$D = \left. \frac{I_1}{-I_2} \right|_{U_2=0} = 2$$

4. H 参数和方程

H 参数也称为混合参数，常用于晶体管等效电路。

① H 参数和方程

$$\begin{cases} \dot{U}_1 = H_{11}\dot{I}_1 + H_{12}\dot{U}_2 \\ \dot{I}_2 = H_{21}\dot{I}_1 + H_{22}\dot{U}_2 \end{cases}$$

矩阵形式:

$$\begin{bmatrix} \dot{U}_1 \\ \dot{I}_2 \end{bmatrix} = \begin{bmatrix} H_{11} & H_{12} \\ H_{21} & H_{22} \end{bmatrix} \begin{bmatrix} \dot{I}_1 \\ \dot{U}_2 \end{bmatrix} = [H] \begin{bmatrix} \dot{I}_1 \\ \dot{U}_2 \end{bmatrix}$$

② H 参数的物理意义计算与测定

$$\begin{cases} \dot{U}_1 = H_{11}\dot{I}_1 + H_{12}\dot{U}_2 \\ \dot{I}_2 = H_{21}\dot{I}_1 + H_{22}\dot{U}_2 \end{cases}$$

$$\left. \begin{aligned} H_{11} &= \left. \frac{\dot{U}_1}{\dot{I}_1} \right|_{\dot{U}_2=0} && \text{输入阻抗} \\ H_{21} &= \left. \frac{\dot{I}_2}{\dot{I}_1} \right|_{\dot{U}_2=0} && \text{电流转移比} \end{aligned} \right\} \begin{array}{l} \text{短路参数} \\ \text{电压转移比} \end{array}$$

$$\left. \begin{aligned} H_{12} &= \left. \frac{\dot{U}_1}{\dot{U}_2} \right|_{\dot{I}_1=0} && \text{电压转移比} \\ H_{22} &= \left. \frac{\dot{I}_2}{\dot{U}_2} \right|_{\dot{I}_1=0} && \text{入端导纳} \end{aligned} \right\} \begin{array}{l} \text{开路参数} \end{array}$$

③ 互易性和对称性

互易二端口: $H_{12} = -H_{21}$

对称二端口: $H_{11}H_{22} - H_{12}H_{21} = 1$

例 求图示两端口的H参数。

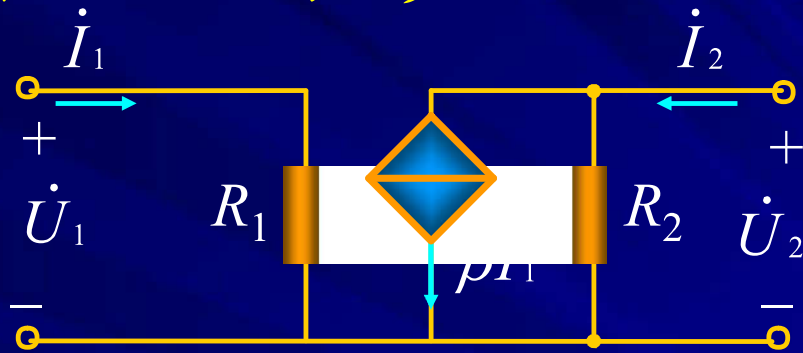

$$\begin{cases} \dot{U}_1 = H_{11}\dot{I}_1 + H_{12}\dot{U}_2 \\ \dot{I}_2 = H_{21}\dot{I}_1 + H_{22}\dot{U}_2 \end{cases}$$

$$\dot{U}_1 = R_1\dot{I}_1$$

$$\dot{I}_2 = \beta\dot{I}_1 + \frac{1}{R_2}\dot{U}_2$$

$$[H] = \begin{bmatrix} R_1 & 0 \\ \beta & 1/R_2 \end{bmatrix}$$

13.3 二端口的等效电路

一个无源二端口网络可以用一个简单的二端口等效模型来代替，要注意的是：

1. 等效条件：等效模型的方程与原二端口网络的方程相同；
2. 根据不同的网络参数和方程可以得到结构完全不同的等效电路；
3. 等效目的是为了分析方便。

1. Z 参数表示的等效电路

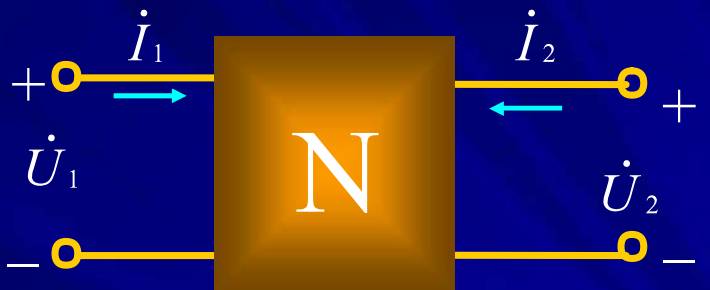
$$\begin{cases} \dot{U}_1 = Z_{11}\dot{I}_1 + Z_{12}\dot{I}_2 \\ \dot{U}_2 = Z_{21}\dot{I}_1 + Z_{22}\dot{I}_2 \end{cases}$$

方法1、直接由参数方程得到等效电路。

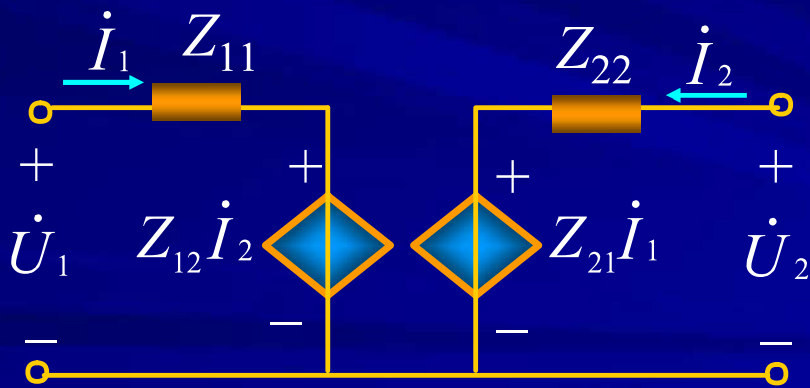

方法2: 采用等效变换的方法。

$$\dot{U}_1 = Z_{11}\dot{I}_1 + Z_{12}\dot{I}_2 = (Z_{11} - Z_{12})\dot{I}_1 + Z_{12}(\dot{I}_1 + \dot{I}_2)$$

$$\dot{U}_2 = Z_{21}\dot{I}_1 + Z_{22}\dot{I}_2$$

$$= Z_{12}(\dot{I}_1 + \dot{I}_2) + (Z_{22} - Z_{12})\dot{I}_2 + (Z_{21} - Z_{12})\dot{I}_1$$

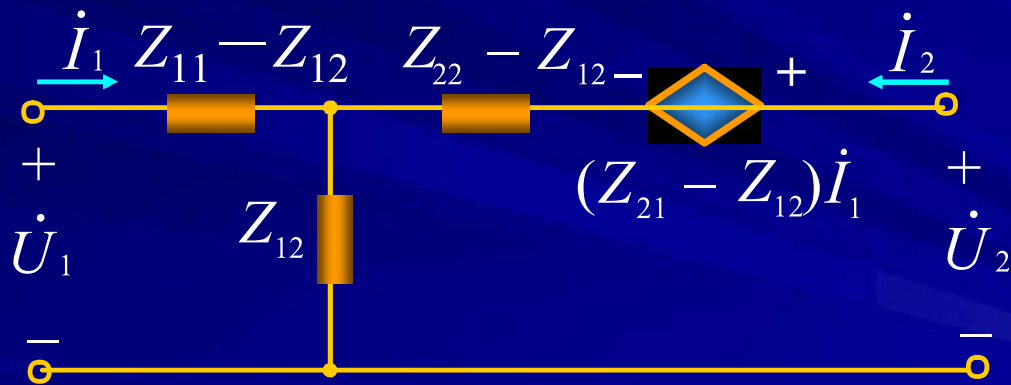

如果网络是互易的，上图变为T型等效电路。

2. Y 参数表示的等效电路

$$\begin{cases} \dot{I}_1 = Y_{11}\dot{U}_1 + Y_{12}\dot{U}_2 \\ \dot{I}_2 = Y_{21}\dot{U}_1 + Y_{22}\dot{U}_2 \end{cases}$$

方法1、直接由参数方程得到等效电路。

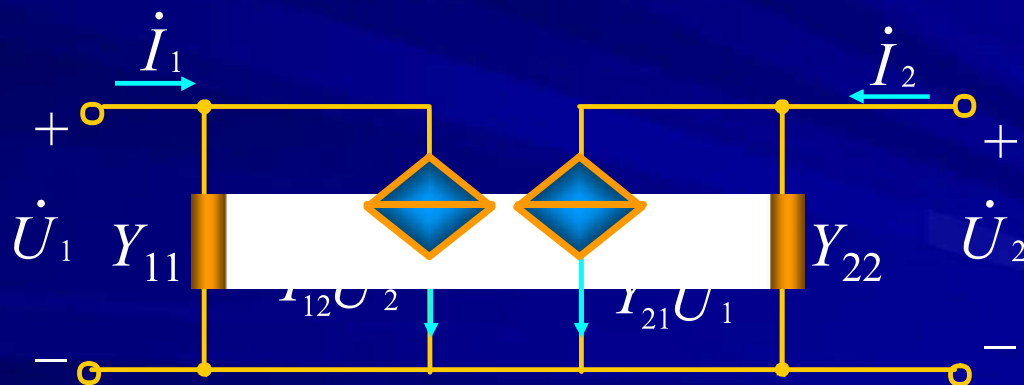

方法2: 采用等效变换的方法。

$$\dot{I}_1 = Y_{11}\dot{U}_1 + Y_{12}\dot{U}_2 = (Y_{11} + Y_{12})\dot{U}_1 - Y_{12}(\dot{U}_1 - \dot{U}_2)$$

$$\dot{I}_2 = Y_{21}\dot{U}_1 + Y_{22}\dot{U}_2$$

$$= -Y_{12}(\dot{U}_2 - \dot{U}_1) + (Y_{22} + Y_{12})\dot{U}_2 + (Y_{21} - Y_{12})\dot{U}_1$$

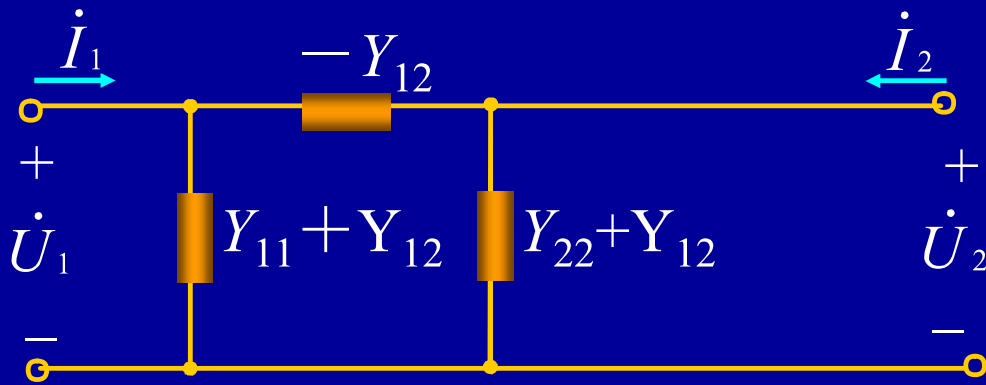

如果网络是互易的，上图变为 π 型等效电路。



注意

- ① 等效只对两个端口的电压，电流关系成立。对端口间电压则不一定成立。
- ② 一个二端口网络在满足相同网络方程的条件下，其等效电路模型不是唯一的；
- ③ 若网络对称则等效电路也对称。
- ④ π 型和T型等效电路可以互换，根据其它参数与Y、Z参数的关系，可以得到用其它参数表示的 π 型和T型等效电路。

例 绘出给定的 Y 参数的任意一种二端口等效电路

$$[Y] = \begin{bmatrix} 5 & -2 \\ -2 & 3 \end{bmatrix}$$

解 由矩阵可知： $Y_{12} = Y_{21}$ 二端口是互易的。

故可用无源 π 型二端口网络作为等效电路。

$$\begin{aligned} Y_a &= Y_{11} + Y_{12} \\ &= 5 - 2 = 3 \end{aligned}$$

$$\begin{aligned} Y_c &= Y_{22} + Y_{12} \\ &= 3 - 2 = 1 \end{aligned}$$

$$Y_b = -Y_{12} = 2$$

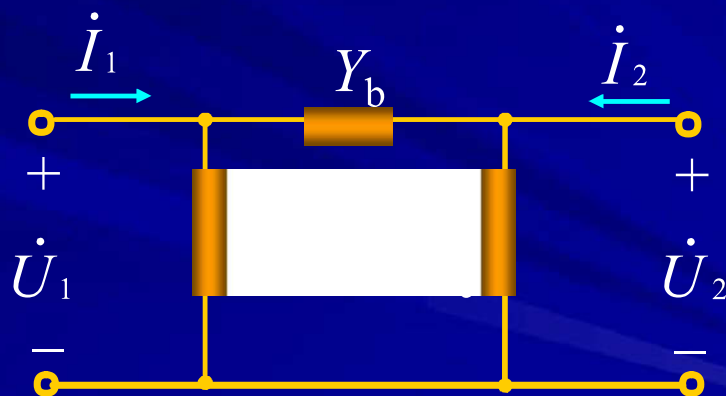

通过 π 型 \rightarrow T型变换可得T型等效电路。

13.4 二端口的转移函数

二端口常为完成某种功能起着耦合两部分电路的作用，这种功能往往是通过转移函数描述或指定的。因此，二端口的转移函数是一个很重要的概念。

二端口转移函数



二端口的转移函数（传递函数），就是用拉氏变换形式表示的输出电压或电流与输入电压或电流之比。

1. 无端接二端口的转移函数

二端口没有外接负载及输入激励无内阻抗时的二端口称为无端接的二端口。



$$\frac{U_2(s)}{U_1(s)}$$

电压转移函数

$$\frac{I_2(s)}{U_1(s)}$$

转移导纳

$$\frac{I_2(s)}{I_1(s)}$$

电流转移函数

$$\frac{U_2(s)}{I_1(s)}$$

转移阻抗

例 给出用Z参数表示的无端接二端口转移函数。

解 Z参数方程:

$$\begin{cases} U_1(s) = Z_{11}(s)I_1(s) + Z_{12}(s)I_2(s) \\ U_2(s) = Z_{21}(s)I_1(s) + Z_{22}(s)I_2(s) \end{cases}$$

令: $I_2(s)=0$
$$\begin{cases} U_1(s) = Z_{11}(s)I_1(s) \\ U_2(s) = Z_{21}(s)I_1(s) \end{cases}$$

$$\frac{U_2(s)}{U_1(s)} = \frac{Z_{21}(s)}{Z_{11}(s)}$$

电压转移函数

$$\frac{U_2(s)}{I_1(s)} = Z_{21}(s)$$

转移阻抗

$$\begin{cases} U_1(s) = Z_{11}(s)I_1(s) + Z_{12}(s)I_2(s) \\ U_2(s) = Z_{21}(s)I_1(s) + Z_{22}(s)I_2(s) \end{cases}$$

令: $U_2(s)=0$ $\frac{I_2(s)}{I_1(s)} = -\frac{Z_{21}(s)}{Z_{22}(s)}$

电流转移函数

$$\frac{I_2(s)}{U_1(s)} = \frac{Z_{21}(s)}{Z_{12}(s)Z_{21}(s) - Z_{11}(s)Z_{22}(s)}$$

转移导纳



注意 同理可得到用 Y 、 T 、 H 参数表示的
无端接二端口转移函数。

2. 有端接二端口的转移函数

二端口的输出端口接有负载阻抗，输入端口接有电压源和阻抗的串联组合或电流源和阻抗的并联组合，称为有端接的二端口。

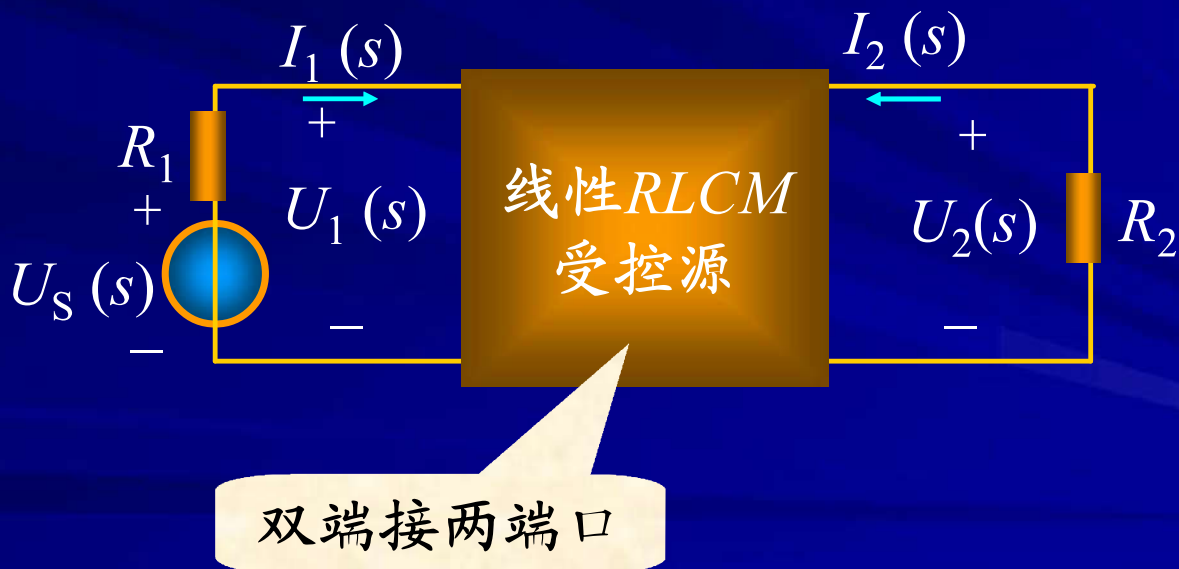

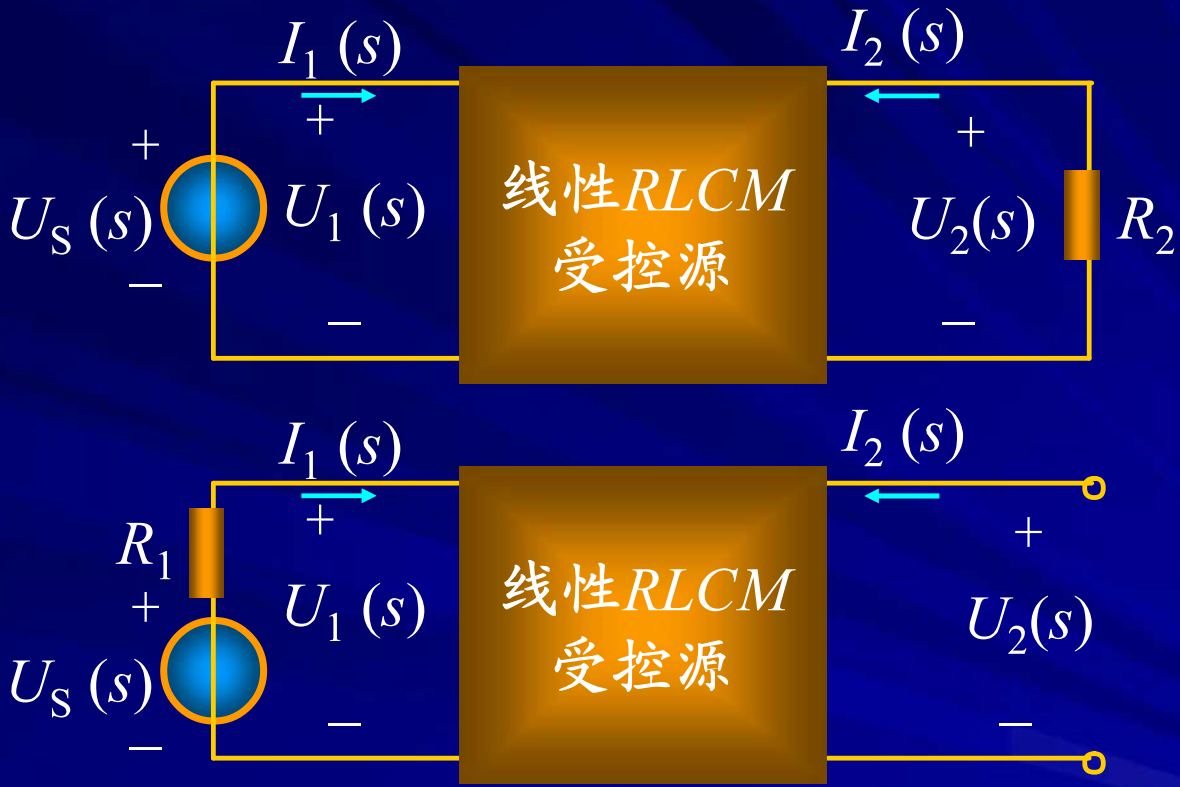

单端接两端口



注意 有端接二端口的转移函数与端接阻抗有关。

例 写出图示单端接二端口的转移函数。



解

$$I_2(s) = Y_{21}(s)U_1(s) + Y_{22}(s)U_2(s)$$

$$I_1(s) = Y_{11}(s)U_1(s) + Y_{12}(s)U_2(s)$$

$$U_1(s) = Z_{11}(s)I_1(s) + Z_{12}(s)I_2(s)$$

$$U_2(s) = Z_{21}(s)I_1(s) + Z_{22}(s)I_2(s)$$

$$U_2(s) = -R_2I_2(s)$$

$$\rightarrow \frac{I_2(s)}{U_1(s)} = \frac{Y_{21}(s)/R}{Y_{22}(s) + \frac{1}{R}}$$

转移导纳

$$\frac{U_2(s)}{I_1(s)} = \frac{RZ_{21}(s)}{R + Z_{22}(s)}$$

转移阻抗

$$\frac{I_2(s)}{I_1(s)} = \frac{Y_{21}(s)Z_{11}(s)}{1 + Y_{22}(s)R - Z_{12}(s)Y_{21}(s)}$$

电流转移函数

$$\frac{U_2(s)}{U_1(s)} = \frac{Z_{21}(s)Y_{11}(s)}{1 + Z_{22}(s)\frac{1}{R} - Z_{21}(s)Y_{12}(s)}$$

电压转移函数

返回

上页

下页

13.5 二端口的连接

一个复杂二端口网络可以看作是由若干简单的二端口按某种方式连接而成，这将使电路分析得到简化。

1. 级联(链联)

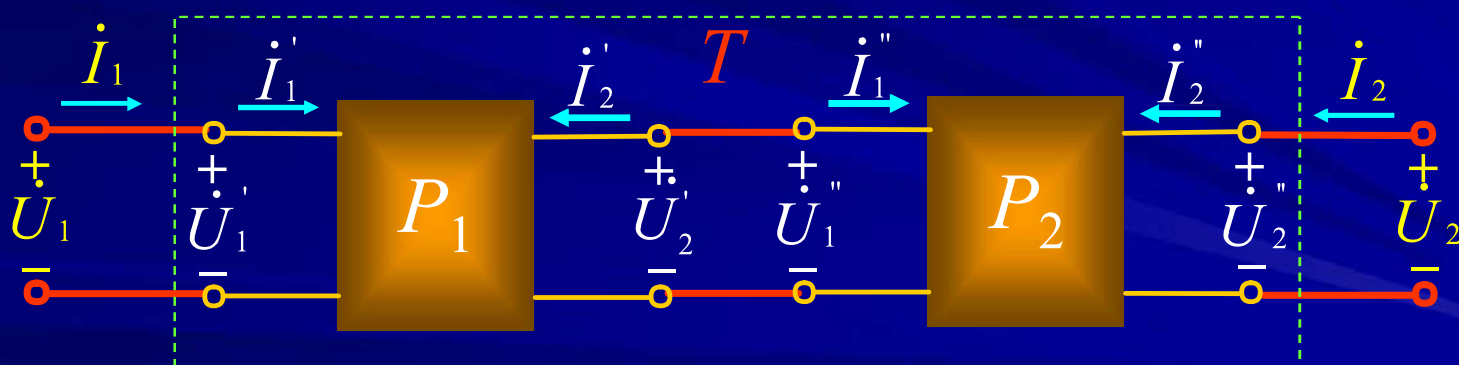

设 $[T'] = \begin{bmatrix} A' & B' \\ C' & D' \end{bmatrix}$ $[T''] = \begin{bmatrix} A'' & B'' \\ C'' & D'' \end{bmatrix}$

即 $\begin{bmatrix} \dot{U}'_1 \\ \dot{I}'_1 \end{bmatrix} = \begin{bmatrix} A' & B' \\ C' & D' \end{bmatrix} \begin{bmatrix} \dot{U}'_2 \\ -\dot{I}'_2 \end{bmatrix}$ $\begin{bmatrix} \dot{U}''_1 \\ \dot{I}''_1 \end{bmatrix} = \begin{bmatrix} A'' & B'' \\ C'' & D'' \end{bmatrix} \begin{bmatrix} \dot{U}''_2 \\ -\dot{I}''_2 \end{bmatrix}$

级联后 $\begin{bmatrix} \dot{U}_1 \\ \dot{I}_1 \end{bmatrix} = \begin{bmatrix} \dot{U}'_1 \\ \dot{I}'_1 \end{bmatrix}$ $\begin{bmatrix} \dot{U}'_2 \\ -\dot{I}'_2 \end{bmatrix} = \begin{bmatrix} \dot{U}''_1 \\ \dot{I}''_1 \end{bmatrix}$ $\begin{bmatrix} \dot{U}''_2 \\ -\dot{I}''_2 \end{bmatrix} = \begin{bmatrix} \dot{U}_2 \\ -\dot{I}_2 \end{bmatrix}$

则 $\begin{bmatrix} \dot{U}_1 \\ \dot{I}_1 \end{bmatrix} = \begin{bmatrix} \dot{U}'_1 \\ \dot{I}'_1 \end{bmatrix} = \begin{bmatrix} A' & B' \\ C' & D' \end{bmatrix} \begin{bmatrix} \dot{U}'_2 \\ -\dot{I}'_2 \end{bmatrix}$

$$= \begin{bmatrix} A' & B' \\ C' & D' \end{bmatrix} \begin{bmatrix} A'' & B'' \\ C'' & D'' \end{bmatrix} \begin{bmatrix} \dot{U}_2 \\ -\dot{I}_2 \end{bmatrix} = \begin{bmatrix} A & B \\ C & D \end{bmatrix} \begin{bmatrix} \dot{U}_2 \\ -\dot{I}_2 \end{bmatrix}$$

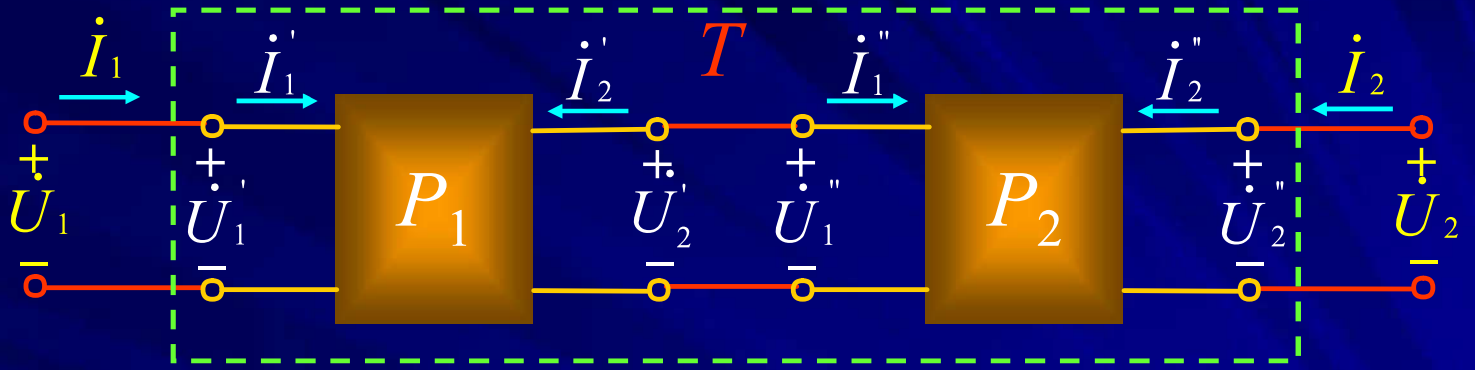

则

$$\begin{bmatrix} A & B \\ C & D \end{bmatrix} = \begin{bmatrix} A' & B' \\ C' & D' \end{bmatrix} \begin{bmatrix} A'' & B'' \\ C'' & D'' \end{bmatrix}$$

$$= \begin{bmatrix} A'A'' + B'C'' & A'B'' + B'D'' \\ C'A'' + D'C'' & C'B'' + D'D'' \end{bmatrix}$$

即:

$$[T] = [T'] [T'']$$



结论 级联后所得复合二端口 T 参数矩阵等于级联的二端口 T 参数矩阵相乘。上述结论可推广到 n 个二端口级联的关系。



注意

① 级联时 T 参数是矩阵相乘的关系，不是对应元素相乘。

$$\begin{aligned} \begin{bmatrix} A & B \\ C & D \end{bmatrix} &= \begin{bmatrix} A' & B' \\ C' & D' \end{bmatrix} \begin{bmatrix} A'' & B'' \\ C'' & D'' \end{bmatrix} \\ &= \begin{bmatrix} A'A'' + B'C'' & A'B'' + B'D'' \\ C'A'' + D'C'' & C'B'' + D'D'' \end{bmatrix} \end{aligned}$$

显然 $A = A'A'' + B'C'' \neq A'A''$

② 级联时各二端口的端口条件不会被破坏。

例 求两端口的 T 参数。

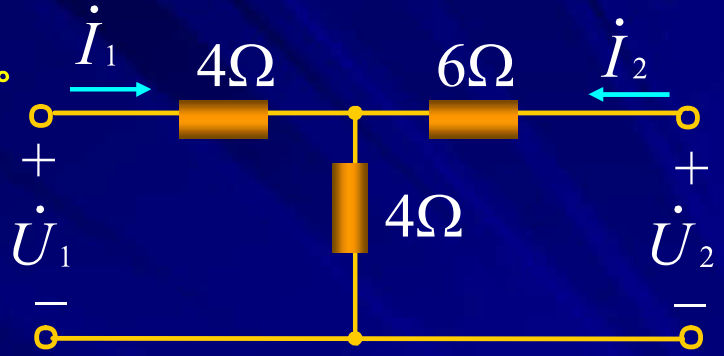

解 易求出

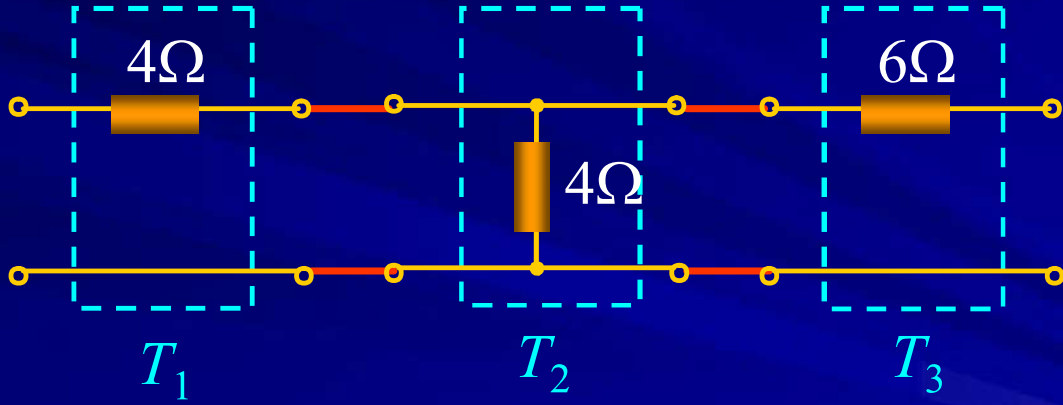

$$T_1 = \begin{bmatrix} 1 & 4\Omega \\ 0 & 1 \end{bmatrix}$$

$$T_2 = \begin{bmatrix} 1 & 0 \\ 0.25\text{ S} & 1 \end{bmatrix}$$

$$T_3 = \begin{bmatrix} 1 & 6\Omega \\ 0 & 1 \end{bmatrix}$$

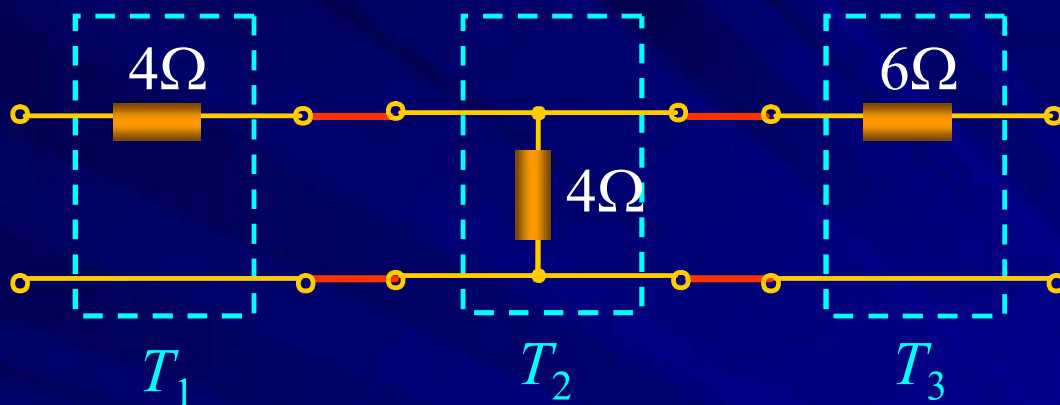

则 $[T] = [T_1][T_2][T_3] = \begin{bmatrix} 1 & 4 \\ 0 & 1 \end{bmatrix} \begin{bmatrix} 1 & 0 \\ 0.25 & 1 \end{bmatrix} \begin{bmatrix} 1 & 6 \\ 0 & 1 \end{bmatrix}$

$$= \begin{bmatrix} 2 & 16\Omega \\ 0.25\text{S} & 2.5 \end{bmatrix}$$

2. 并联

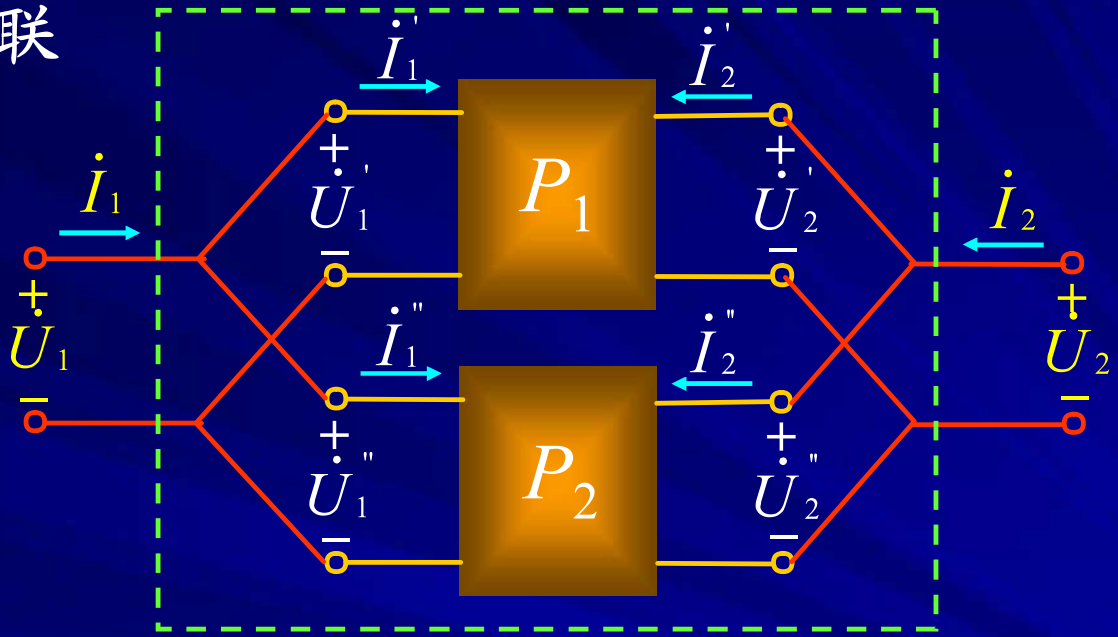

并联采用Y参数方便。

$$\begin{bmatrix} \dot{I}'_1 \\ \dot{I}'_2 \end{bmatrix} = \begin{bmatrix} Y'_{11} & Y'_{12} \\ Y'_{21} & Y'_{22} \end{bmatrix} \begin{bmatrix} \dot{U}'_1 \\ \dot{U}'_2 \end{bmatrix} \quad \begin{bmatrix} \dot{I}''_1 \\ \dot{I}''_2 \end{bmatrix} = \begin{bmatrix} Y''_{11} & Y''_{12} \\ Y''_{21} & Y''_{22} \end{bmatrix} \begin{bmatrix} \dot{U}''_1 \\ \dot{U}''_2 \end{bmatrix}$$

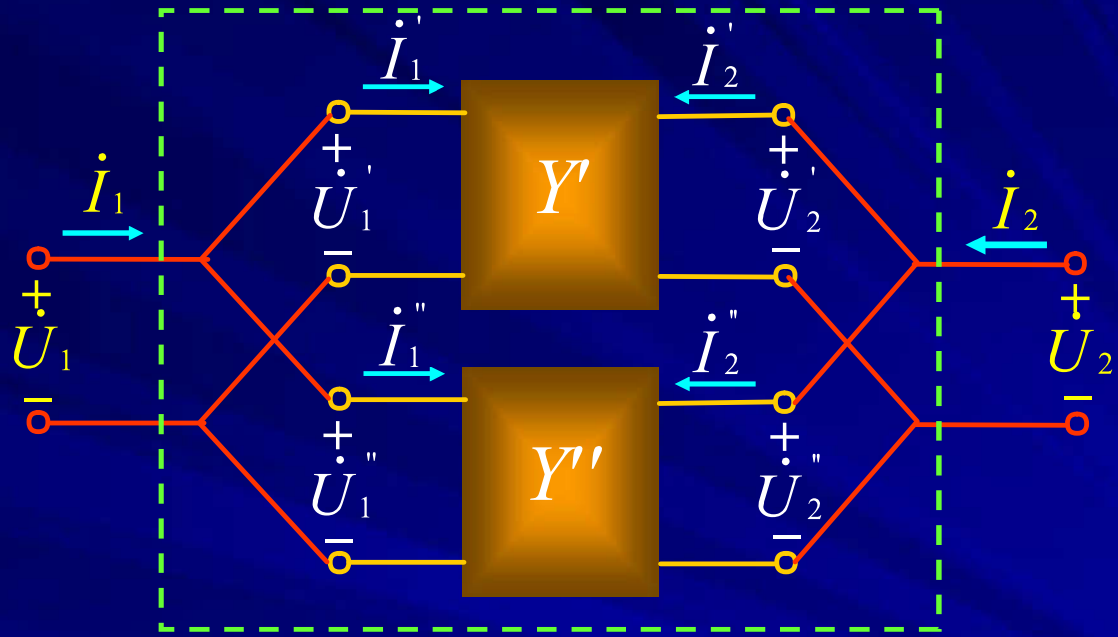

并联后

$$\begin{bmatrix} \dot{U}_1 \\ \dot{U}_2 \end{bmatrix} = \begin{bmatrix} \dot{U}'_1 \\ \dot{U}'_2 \end{bmatrix} = \begin{bmatrix} \dot{U}''_1 \\ \dot{U}''_2 \end{bmatrix} \quad \begin{bmatrix} \dot{I}_1 \\ \dot{I}_2 \end{bmatrix} = \begin{bmatrix} \dot{I}'_1 \\ \dot{I}'_2 \end{bmatrix} + \begin{bmatrix} \dot{I}''_1 \\ \dot{I}''_2 \end{bmatrix}$$

$$\begin{aligned}\begin{bmatrix} \dot{I}_1 \\ \dot{I}_2 \end{bmatrix} &= \begin{bmatrix} \dot{I}'_1 \\ \dot{I}'_2 \end{bmatrix} + \begin{bmatrix} \dot{I}''_1 \\ \dot{I}''_2 \end{bmatrix} = \begin{bmatrix} Y'_{11} & Y'_{12} \\ Y'_{21} & Y'_{22} \end{bmatrix} \begin{bmatrix} \dot{U}'_1 \\ \dot{U}'_2 \end{bmatrix} + \begin{bmatrix} Y''_{11} & Y''_{12} \\ Y''_{21} & Y''_{22} \end{bmatrix} \begin{bmatrix} \dot{U}''_1 \\ \dot{U}''_2 \end{bmatrix} \\ &= \left\{ \begin{bmatrix} Y'_{11} & Y'_{12} \\ Y'_{21} & Y'_{22} \end{bmatrix} + \begin{bmatrix} Y''_{11} & Y''_{12} \\ Y''_{21} & Y''_{22} \end{bmatrix} \right\} \begin{bmatrix} \dot{U}_1 \\ \dot{U}_2 \end{bmatrix} \\ &= \begin{bmatrix} Y'_{11} + Y''_{11} & Y'_{12} + Y''_{12} \\ Y'_{21} + Y''_{21} & Y'_{22} + Y''_{22} \end{bmatrix} \begin{bmatrix} \dot{U}_1 \\ \dot{U}_2 \end{bmatrix} = [Y] \begin{bmatrix} \dot{U}_1 \\ \dot{U}_2 \end{bmatrix}\end{aligned}$$

可得

$$[Y] = [Y'] + [Y'']$$



结论 二端口并联所得复合二端口的 Y 参数矩阵等于两个二端口 Y 参数矩阵相加。



注意 ① 两个二端口并联时，其端口条件可能被破坏，此时上述关系式将不成立。

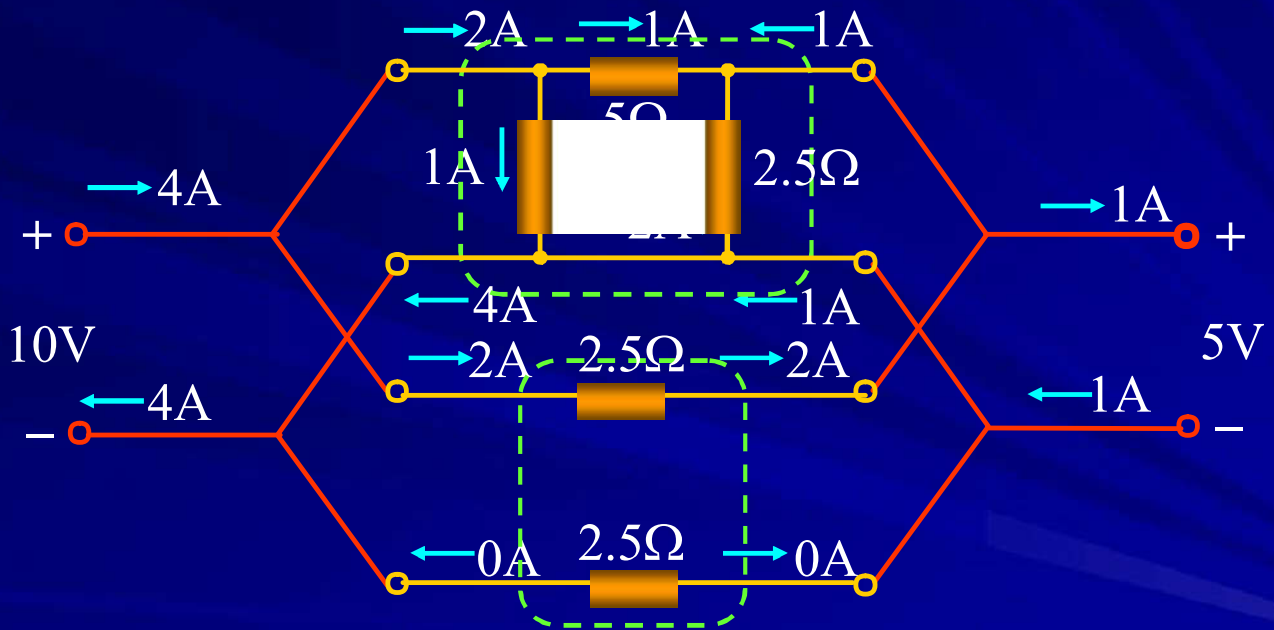

并联后端口条件破坏。

- ② 具有公共端的二端口 (三端网络形成的二端口), 将公共端并在一起将不会破坏端口条件。

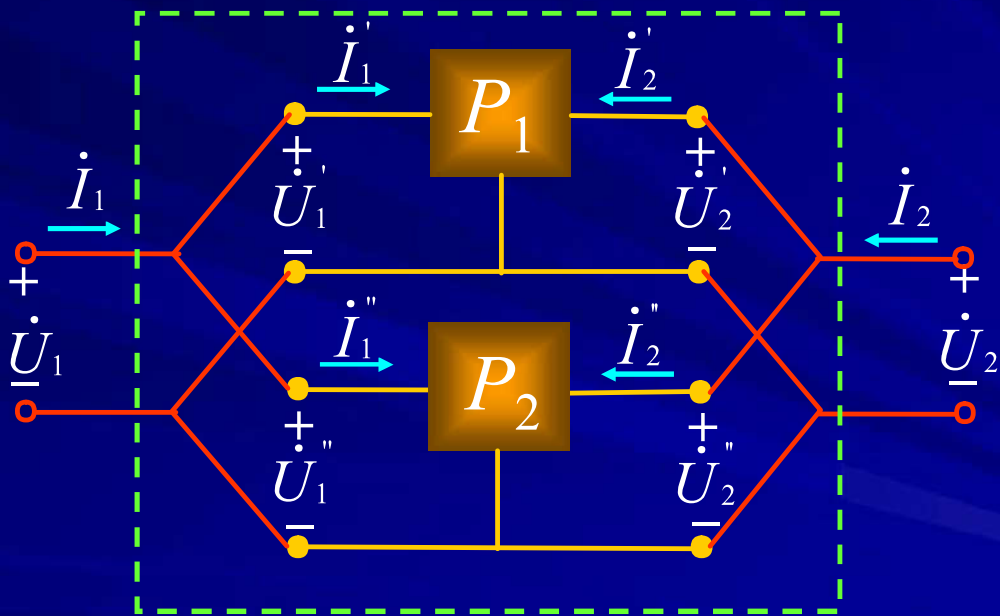

例

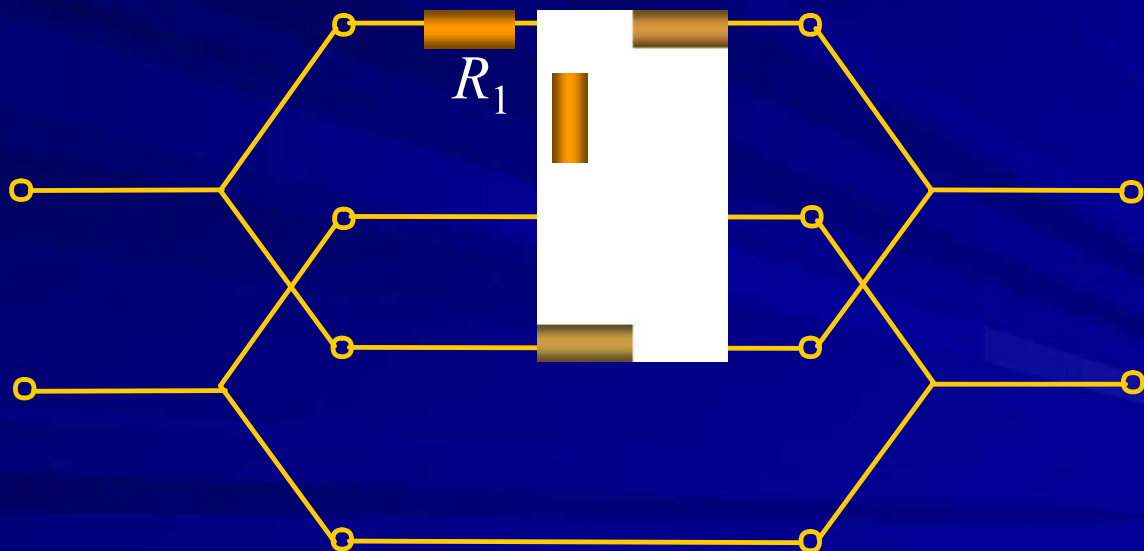
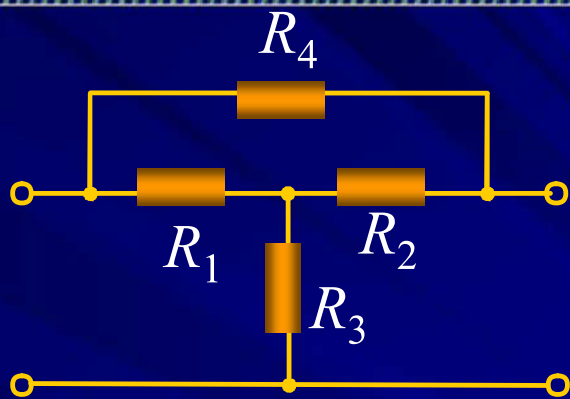

3. 串联

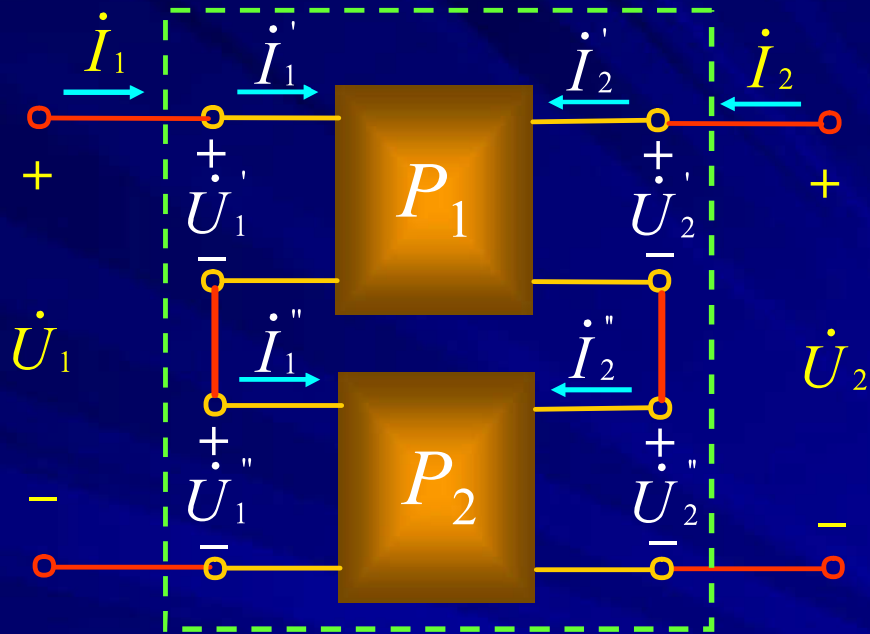

串联采用Z参数方便。

$$\begin{bmatrix} \dot{U}'_1 \\ \dot{U}'_2 \end{bmatrix} = \begin{bmatrix} Z'_{11} & Z'_{12} \\ Z'_{21} & Z'_{22} \end{bmatrix} \begin{bmatrix} \dot{I}'_1 \\ \dot{I}'_2 \end{bmatrix} \quad \begin{bmatrix} \dot{U}''_1 \\ \dot{U}''_2 \end{bmatrix} = \begin{bmatrix} Z''_{11} & Z''_{12} \\ Z''_{21} & Z''_{22} \end{bmatrix} \begin{bmatrix} \dot{I}''_1 \\ \dot{I}''_2 \end{bmatrix}$$

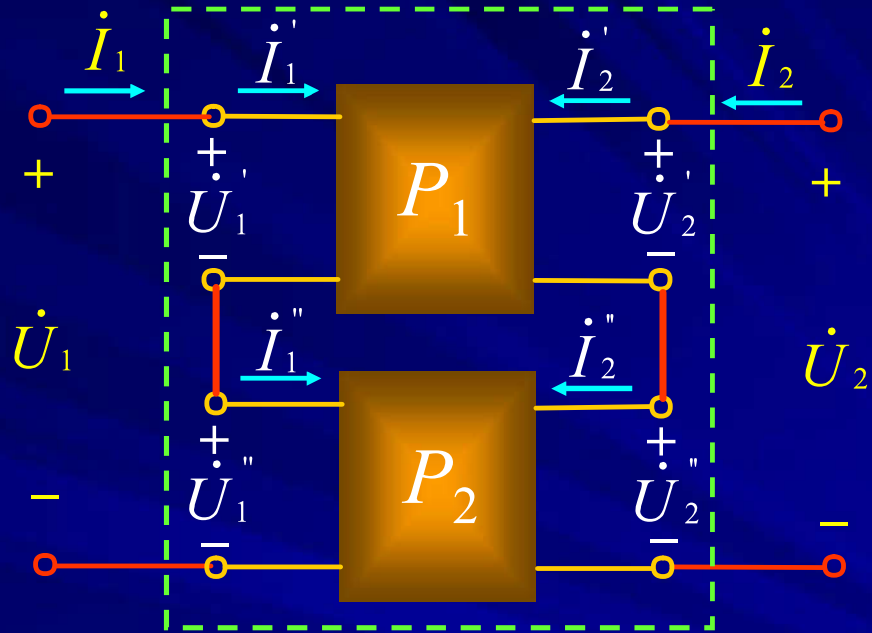

$$\begin{bmatrix} \dot{I}_1 \\ \dot{I}_2 \end{bmatrix} = \begin{bmatrix} \dot{I}'_1 \\ \dot{I}'_2 \end{bmatrix} = \begin{bmatrix} \dot{I}''_1 \\ \dot{I}''_2 \end{bmatrix} \quad \begin{bmatrix} \dot{U}_1 \\ \dot{U}_2 \end{bmatrix} = \begin{bmatrix} \dot{U}'_1 \\ \dot{U}'_2 \end{bmatrix} + \begin{bmatrix} \dot{U}''_1 \\ \dot{U}''_2 \end{bmatrix}$$

$$\begin{aligned} \begin{bmatrix} \dot{U}_1 \\ \dot{U}_2 \end{bmatrix} &= \begin{bmatrix} \dot{U}'_1 \\ \dot{U}'_2 \end{bmatrix} + \begin{bmatrix} \dot{U}''_1 \\ \dot{U}''_2 \end{bmatrix} = [Z'] \begin{bmatrix} \dot{I}'_1 \\ \dot{I}'_2 \end{bmatrix} + [Z''] \begin{bmatrix} \dot{I}''_1 \\ \dot{I}''_2 \end{bmatrix} \\ &= \{[Z'] + [Z'']\} \begin{bmatrix} \dot{I}_1 \\ \dot{I}_2 \end{bmatrix} = [Z] \begin{bmatrix} \dot{I}_1 \\ \dot{I}_2 \end{bmatrix} \end{aligned}$$

则

$$[Z] = [Z'] + [Z'']$$



结论 串联后复合二端口 Z 参数矩阵等于原二端口 Z 参数矩阵相加。可推广到 n 端口串联。



注意 ① 串联后端口条件可能被破坏，此时上述关系式将不成立，需检查端口条件。

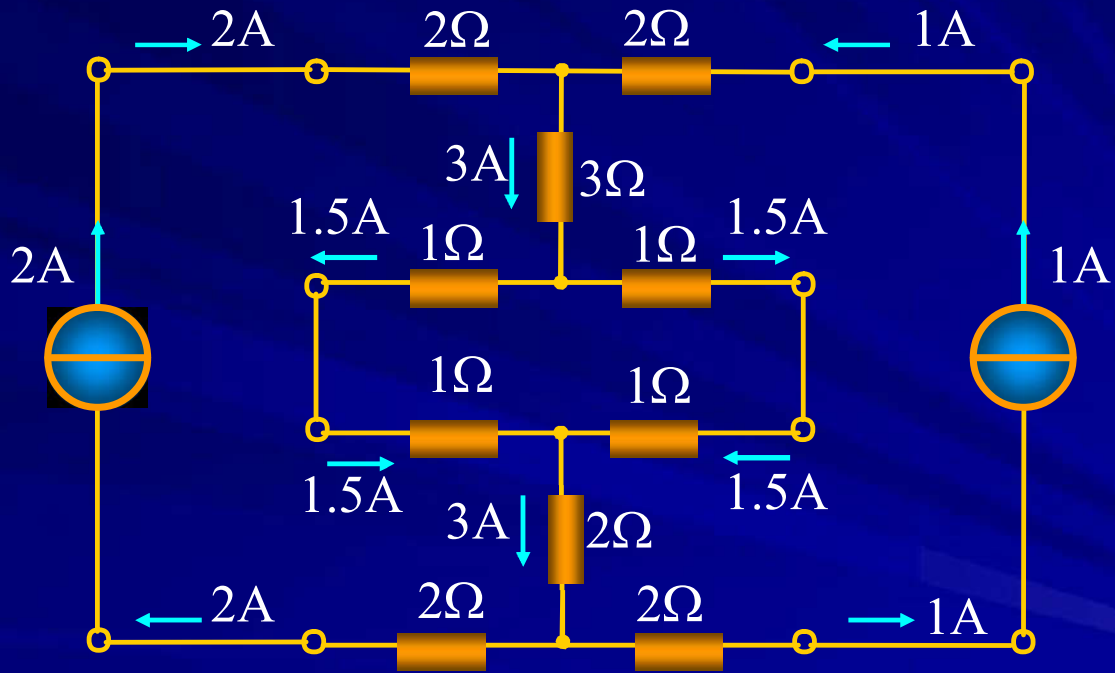

端口条件破坏！

- ② 具有公共端的二端口，将公共端串联时将不会破坏端口条件。

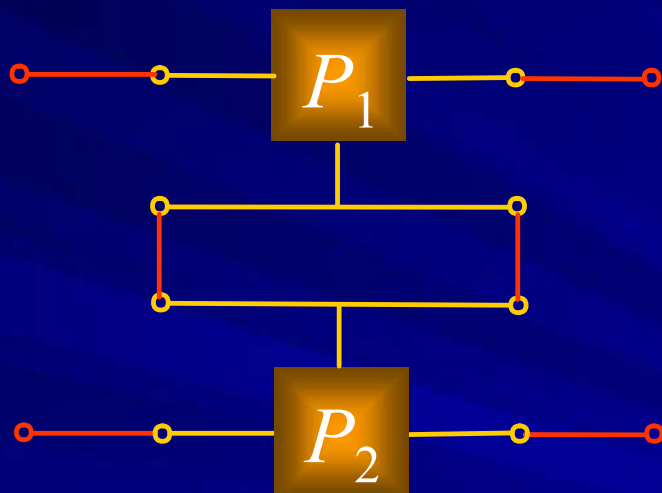

端口条件不会破坏.

例

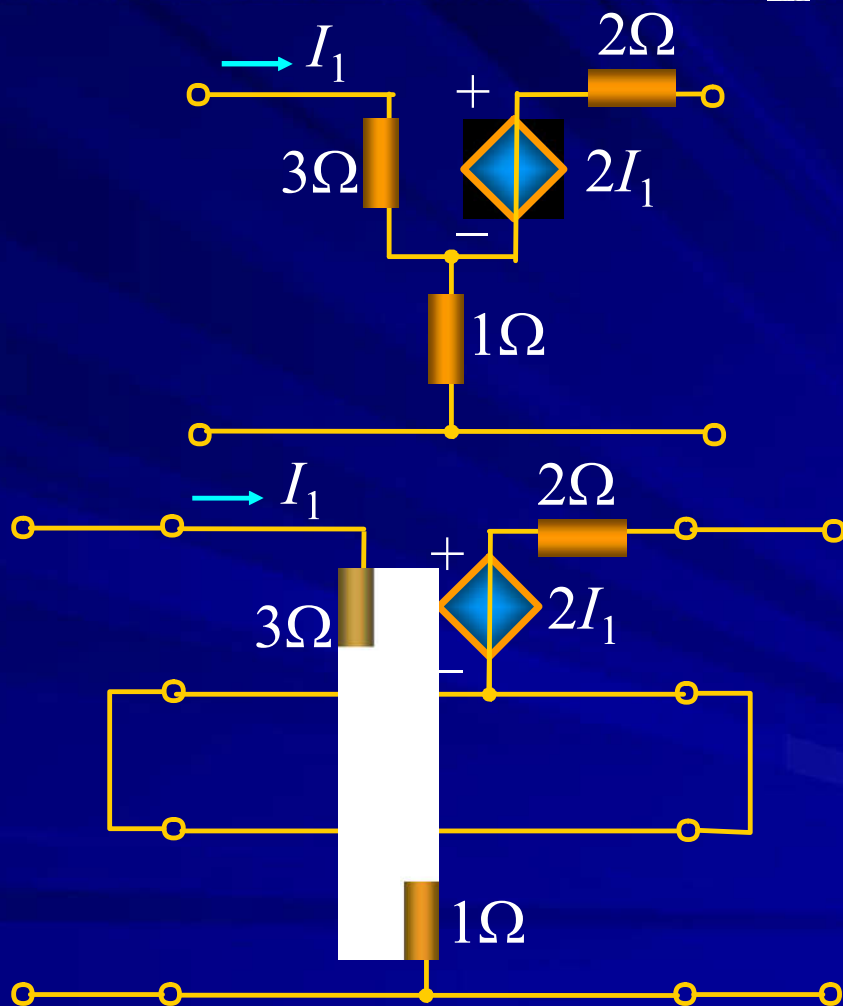

13.6 回转器和负阻抗转换器

1. 回转器

回转器是一种线性非互易的多端元件，可以用晶体管电路或运算放大器来实现。

① 回转器的基本特性

● 符号

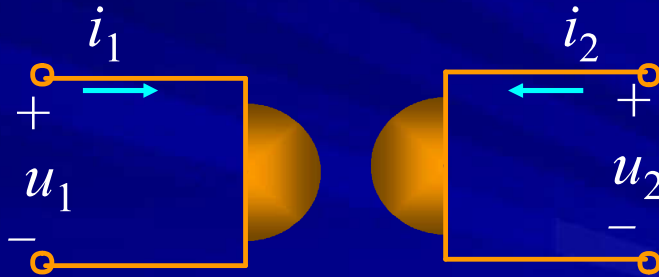

● 电压电流关系

$$\begin{cases} u_1 = -ri_2 \\ u_2 = ri_1 \end{cases}$$

回转电阻

返回

上页

下页

或写为

$$\begin{cases} i_1 = gu_2 \\ i_2 = -gu_1 \end{cases}$$

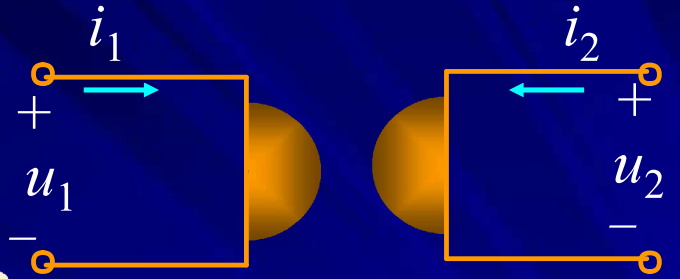

回转电导

$r = \frac{1}{g}$ → 简称回转常数，表征回转器特性的参数。

• Z、Y、T参数

Z参数

$$\begin{bmatrix} u_1 \\ u_2 \end{bmatrix} = \begin{bmatrix} 0 & -r \\ r & 0 \end{bmatrix} \begin{bmatrix} i_1 \\ i_2 \end{bmatrix}$$

$$[Z] = \begin{bmatrix} 0 & -r \\ r & 0 \end{bmatrix}$$

$$Z_{12} \neq Z_{21}$$

Y参数

$$\begin{bmatrix} i_1 \\ i_2 \end{bmatrix} = \begin{bmatrix} 0 & g \\ -g & 0 \end{bmatrix} \begin{bmatrix} u_1 \\ u_2 \end{bmatrix}$$

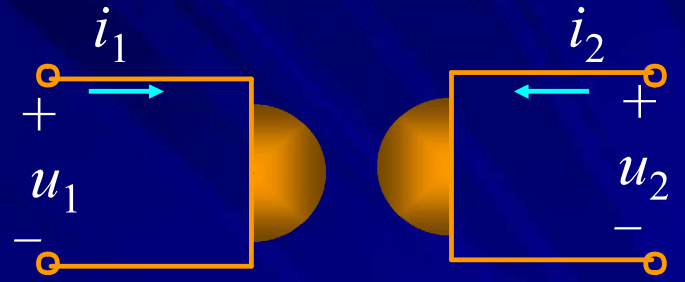

$$[Y] = \begin{bmatrix} 0 & g \\ -g & 0 \end{bmatrix}$$

$$Y_{12} \neq Y_{21}$$

$$\Delta[T] \neq 1$$

$$T \text{ 参数 } \begin{bmatrix} u_1 \\ i_1 \end{bmatrix} = \begin{bmatrix} 0 & \frac{1}{g} \\ g & 0 \end{bmatrix} \begin{bmatrix} u_2 \\ i_2 \end{bmatrix} \quad [T] = \begin{bmatrix} 0 & \frac{1}{g} \\ g & 0 \end{bmatrix}$$



结论 回转器是非互易的两端口网络。

● 功率

任一瞬间输入回转器的功率为：

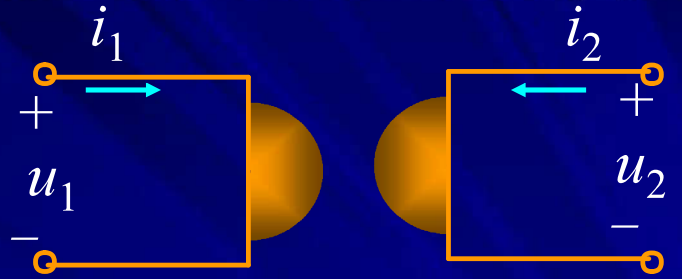

$$u_1 i_1 + u_2 i_2 = -r i_1 i_2 + r i_1 i_2 = 0$$



结论 理想回转器是不储能、不耗能的无源性两端口元件。

② 回转器的等效电路

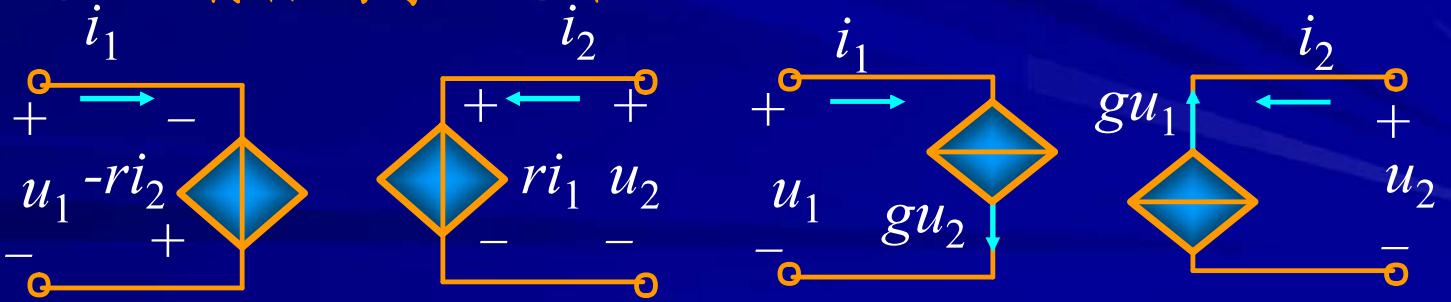

③ 回转器的应用

例1 回转器的逆变性

图示电路的输入阻抗为：

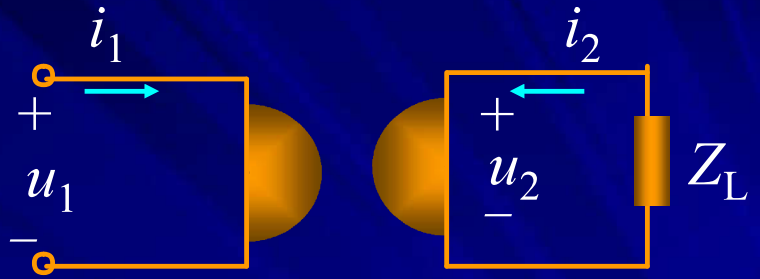

$$Z_i = \frac{u_1}{i_1} = \frac{-ri_2}{u_2/r} = \frac{r^2}{Z_L}$$

逆变性

若： $Z_L = \frac{1}{j\omega C} \rightarrow Z_i = r^2 \cdot j\omega C$



结论 回转器具有把一个电容回转为一个电感的本领，实现了没有磁场的电感，这为实现难于集成的电感提供了可能性。

例2 利用回转器实现理想变压器。

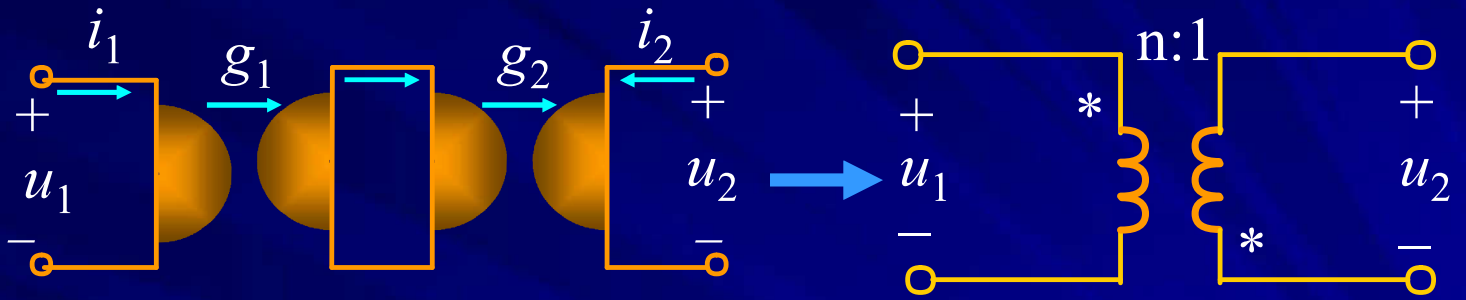

图示电路的 T 参数为：

$$[T] = \begin{bmatrix} 0 & \frac{1}{g_1} \\ g_1 & 0 \end{bmatrix} \begin{bmatrix} 0 & -1 \\ g_2 & 0 \end{bmatrix} = \begin{bmatrix} \frac{g_2}{g_1} & 0 \\ 0 & -\frac{g_1}{g_2} \end{bmatrix} = \begin{bmatrix} n & 0 \\ 0 & -\frac{1}{n} \end{bmatrix}$$



结论 两个回转器的级联相当于一个变比 $n=g_2/g_1$ 的理想变压器。

2. 负阻抗变换器

负阻抗变换器（简称NIC）是一个能将阻抗按一定比例进行变换并改变其符号的两端口元件，可以用晶体管电路或运算放大器来实现。

① 负阻抗变换器的基本特性

● 符号



● 电压电流关系

$$\begin{cases} u_1 = u_2 \\ i_1 = ki_2 \end{cases}$$

电流反向型

或
$$\begin{cases} u_1 = -ku_2 \\ i_1 = -i_2 \end{cases}$$

电压反
向型

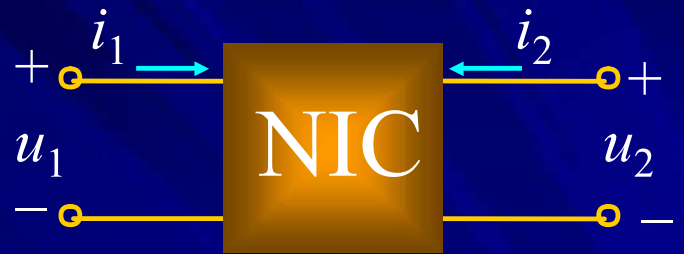

• T 参数

$$[T] = \begin{bmatrix} 1 & 0 \\ 0 & -k \end{bmatrix} \quad \text{or} \quad [T] = \begin{bmatrix} -k & 0 \\ 0 & 1 \end{bmatrix}$$

② 正阻抗变为负阻抗的性质

$$Z_i = \frac{u_1}{i_1} = \frac{u_2}{ki_2} = -\frac{Z_L}{k}$$

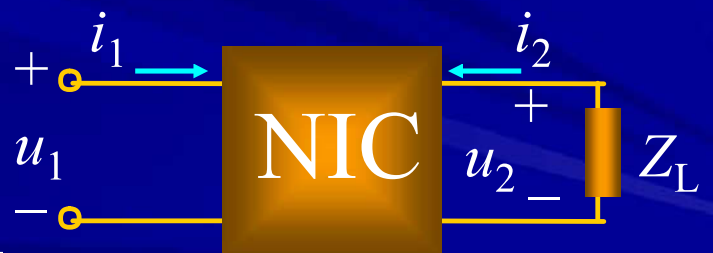

$$\text{or } Z_i = \frac{u_1}{i_1} = \frac{-ku_2}{i_2} = -kZ_L$$

例 负阻抗变换器的 $k=1$ ，求输入阻抗。

解

$$Z_L = \frac{1}{1+j}$$

$$\begin{aligned} Z_i &= 2 - kZ_L = 2 - \frac{1}{1+j} \\ &= 0.5 + j0.5\Omega \end{aligned}$$

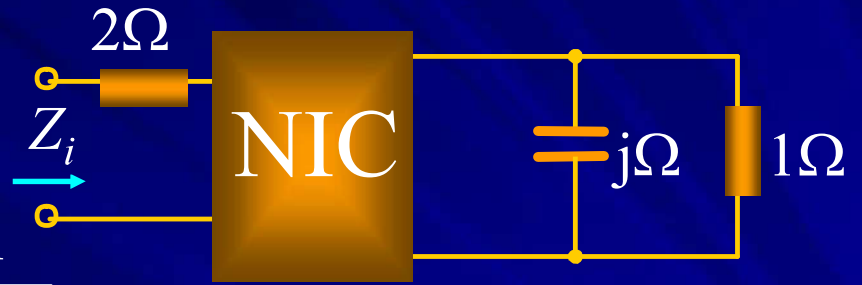

↓ 等效网络

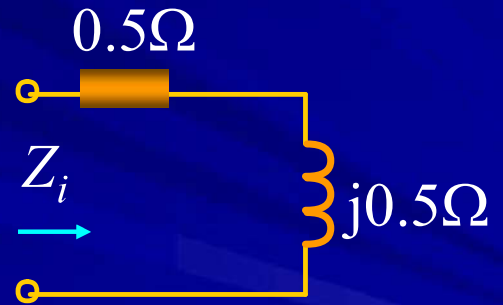

结论

可以用NIC和RC元件组成的网络来实现RL或RLC元件组成的网络。