

International Agency for Research on Cancer THE FIRST

1 9 6 5 - 2 0 1 5



YEARS

International Agency for Research on Cancer



World Health
Organization

Rodolfo Saracci and
Christopher P. Wild

International Agency
for Research on Cancer
THE FIRST

1 9 6 5 - 2 0 1 5

50

YEARS

International Agency for Research on Cancer



Rodolfo Saracci and
Christopher P. Wild

Published by the International Agency for Research on Cancer,
150 cours Albert Thomas, 69372 Lyon Cedex 08, France

©International Agency for Research on Cancer, 2015

Distributed by
WHO Press, World Health Organization, 20 Avenue Appia, 1211 Geneva 27, Switzerland
(tel: +41 22 791 3264; fax: +41 22 791 4857; email: bookorders@who.int).

Publications of the World Health Organization enjoy copyright protection in accordance with the provisions of Protocol 2 of the Universal Copyright Convention. All rights reserved.

The designations employed and the presentation of the material in this publication do not imply the expression of any opinion whatsoever on the part of the Secretariat of the World Health Organization concerning the legal status of any country, territory, city, or area or of its authorities, or concerning the delimitation of its frontiers or boundaries.

The boundaries and names shown and the designations used on the maps do not imply the expression of any opinion whatsoever on the part of the World Health Organization concerning the legal status of any country, territory, city, or area or of its authorities, or concerning the delimitation of its frontiers or boundaries. Dotted and dashed lines on maps represent approximate border lines for which there may not yet be full agreement.

The mention of specific companies or of certain manufacturers' products does not imply that they are endorsed or recommended by the World Health Organization in preference to others of a similar nature that are not mentioned. Errors and omissions excepted, the names of proprietary products are distinguished by initial capital letters.

The authors alone are responsible for the views expressed in this publication.

The International Agency for Research on Cancer welcomes requests for permission to reproduce or translate its publications, in part or in full. Requests for permission to reproduce or translate IARC publications – whether for sale or for non-commercial distribution – should be addressed to the IARC Communications Group, at: publications@iarc.fr.

Cover images, from left to right: a child receives a vaccination in Africa (Credit: iStockphoto/Subman); the IARC tower building, located in the eighth district of Lyon, France (Credit: R. Dray/IARC); an IARC laboratory technician uses confocal microscopy to visualize immunostained proteins in fixed cells (Credit: R. Dray/IARC).

This book is also available in electronic format from <http://www.iarc.fr/en/publications/books/iarc50>.

IARC Library Cataloguing in Publication Data

International Agency for Research on Cancer: the first 50 years, 1965–2015 / Rodolfo Saracci and Christopher P. Wild

1. International agencies – history 2. World Health Organization – history 3. Anniversaries and special events
4. Biomedical research – history 5. Neoplasms – prevention and control
I. Saracci, Rodolfo II. Wild, Christopher P.

ISBN 978-92-832-0441-1

(NLM Classification: WA11)

This book is dedicated to

Marika and Heather

who share our passion for the Agency

CONTENTS

Foreword	vi
About this book	vii
About the authors	viii
Acknowledgements	ix
The birth of IARC	10
1965 to 2015: IARC, a unique institution for a changing world	44
Education and training of cancer researchers	70
Innovation in statistical methods	88
Cancer registries: a worldwide endeavour	104
Cancer patterns, trends, and burden	120
Carcinogens in the human environment	138
Nutrition, metabolism, and cancer	160
From laboratory to population	180
Viruses and vaccines	200
Cancer screening and early diagnosis	222
IARC: the second 50 years	236
Further reading	248
Sources	249
IARC Directors and Council chairs	256
Enabling research success	258

FOREWORD

Fifty years ago, led by President Charles de Gaulle, France set an ambitious goal by proposing the establishment of an international cancer institute under the auspices of the World Health Organization (WHO).

The International Agency for Research on Cancer (IARC) has, over half a century, shaped the face of cancer research. It has done so through the establishment of cancer registries around the world, through cancer epidemiology research, and through its training programme, which develops and nurtures cancer scientists. IARC has provided the indispensable cancer evidence base for WHO's public health work.

Fifty years on, IARC has become an essential organization. The membership of its independent governing bodies has grown from the five founding countries to 24, and the number of Participating States continues to grow.

IARC's activities span a wide range of research fields that inform global decision-making for cancer control.

Within WHO, IARC has a special place, as it is the only WHO body that conducts its own research programme and disseminates its findings to the world. It is internationally recognized for setting the agenda in cancer research and prevention.

I have every confidence that IARC will continue to grow and to help WHO intensify its efforts to decrease the global burden of cancer.



Dr Margaret Chan

Director-General, World Health Organization

ABOUT THIS BOOK

This book, published to mark the 50th anniversary of the establishment of the International Agency for Research on Cancer (IARC) by the World Health Assembly in May 1965, introduces the reader to the origins and development, major research themes, and key scientific and public health contributions of IARC in its first 50 years of activity.

The first two chapters describe the events leading up to the foundation of IARC in 1965 and the general societal and medical context in which IARC operated at the time and continues to operate today. The next three chapters highlight the main contributions that IARC has made to the development of tools and infrastructures for cancer research. Then, six chapters outline IARC's key accomplishments in the identification of cancer causes and in cancer prevention. A concluding chapter explores how the principles and vision that have guided IARC in the past are more relevant than ever today, in spite of major evolutions both in cancer as a disease and in cancer research as an activity over the intervening five decades. The book is enhanced throughout by the inclusion of short quotations extracted from a series of interviews with some of the key figures from IARC's history.

This book is in no sense intended to be a history of IARC as professional historians might write in the future. Nor is it intended as a comprehensive, historical overview of all the specific research themes and related activities conducted by IARC scientists past and present. To them, senior and junior, to all the IARC supporting personnel, and to all the thousands of scientists throughout the world who have helped make the Agency what it is, an apology is due to the extent that the nature of this book – selective in topics, minimally technical in style, and (for this reason) only occasionally citing individual papers – fails to do justice to the extent and value of their work, the very essence of IARC. Rather, the book attempts to celebrate, by examples, some of the achievements made by IARC through its collaborative approach worldwide. The responsibility for the selection of those examples, as well as of the quotations from the interviewees, rests solely on the shoulders of the authors.

ABOUT THE AUTHORS



[Rodolfo Saracci](#) first came to IARC in 1976. As an epidemiologist, he worked in the Unit of Epidemiology and Biostatistics, subsequently serving for an extended period (1983–1995) as the head of the Unit of Analytical Epidemiology. Since 2009, he has been an IARC Senior Visiting Scientist.



[Christopher P. Wild](#) arrived at IARC in 1984 with support from an IARC Postdoctoral Fellowship. After working as a scientist in the Unit of Mechanisms of Carcinogenesis, he served as the head of the Unit of Environmental Carcinogenesis (1994–1996). He returned as IARC Director in 2009.

ACKNOWLEDGEMENTS

The publication of this book would not have been possible without valuable contributions from a large number of people.

First, our thanks go to the interviewees, who freely and generously provided their personal memories and viewpoints on the work of IARC and from whose interviews we selected short quotations: Vladimir Anisimov, Bruce Armstrong, Helmut Bartsch, Norman Breslow, Walter Davis, Nick Day, Jacques Estève, Andrew Hall, Nan Higginson, Manolis Kogevinas, Gilbert Lenoir, Julian Little, Tony McMichael, Ruggero Montesano, Nubia Muñoz, Max Parkin, Richard Peto, Thierry Philip, Keiji Saita, Rengaswamy Sankaranarayanan, Ann Shannon, Benedetto Terracini, Christian Trépo, Hiroshi Yamasaki, and David Zaridze. The interviews will be presented elsewhere in a more complete form.

In addition to those interviewees who have previously worked at IARC or collaborated scientifically with the Agency, we also received valuable assistance and insights from Christophe d'Astier de La Vigerie, Geoffroy d'Astier de La Vigerie, François Blancpain, Francis Latarjet, and Jacques Latarjet. The authors would particularly like to thank Francis Latarjet for permission to use photos relating to his father, Raymond Latarjet.

Special thanks are also due to George Klein, who was a member of the first IARC Scientific Council, which met in September 1965, and who also participated in the planning discussions for the new Agency before its creation, for sharing his memories of those formative discussions.

Bruce Armstrong was kind enough to read the full text and thus provide an external check on the content.

For assistance in the preparation of the content of the book, we extend our thanks to Freddie Bray, François Deloche, Roland Dray, Jacques Ferlay, Susan Haver-Legros, Reetta Holmila, Isabelle Soerjomataram, and Véronique Terrasse.

We gratefully acknowledge the constant and skillful support and friendly collaboration of the IARC production team: Natacha Blavoyer (production assistant), Jessica Cox (proofreader), Sarah Dunbar-Khelifi (publishing assistant), Nicolas Gaudin (managing editor), Teresa Lee (knowledge manager), Sylvia Lesage (publishing assistant), and Karen Müller (English editor).

Finally, the design and layout of the book were created by the firm *Messaggio*, which ensured the elegant look of the volume.





THE BIRTH OF IARC

THE BIRTH OF IARC

It is rare, in the history of nations, that one finds good reasons to render homage to the generosity and altruism of governments and those in power: the birth of the International Agency for Research on Cancer presents one of those rare occasions. – Lorenzo Tomatis

Great things are done by a series of small things brought together. – Vincent Van Gogh

AN IDEA – NOVEMBER 1963

It is often difficult to identify the origin of an idea, good or bad. However, in the case of IARC one can reasonably conjecture that its conception was a result of the pain of loss associated with the disease it was created to combat. A single letter from a bereaved husband, relating the suffering of his wife after a cancer diagnosis, troubled the editor of the recipient newspaper and spurred him to action. In turn, his compassion, character, and connections, combined with the optimism of the times, generated the momentum for change. These small individual acts, triggered by emotion and empathy, resulted in an international political response resonating with shared experience across nations.

The letter was written by a journalist based in Nice, Yves Poggioli, a friend of the editor and a fellow member of the Movement for Peace, an organization formed in France after the Second World War. His personal loss triggered efforts from the end of February 1963 to create an international centre to fight against cancer that would be financed by taking resources directly from national budgets destined for nuclear armament. Poggioli approached several different organizations and individuals, including the French government, but with little response. In early April 1963, he approached the newspaper editor, asking him to forward this idea to the World Peace Council, another organization working for nuclear disarmament.

The editor receiving the letter was exceptional in several ways (see “Emmanuel d’Astier de La Vigerie – liberation from the burden of cancer”). Emmanuel d’Astier de La Vigerie was a Frenchman of aristocratic background, born in Paris in the first week of the 20th century. D’Astier attended the French Naval Academy but in his mid-twenties resigned and turned to a mix of journalism, poetry, and opium. A reflective dilettante, he began drifting increasingly to the political left, leaving behind his earlier monarchist tendencies. During the first months of the Second World War, d’Astier re-enlisted in the French Navy. After the fall of France in June 1940, his desire to do something to resist the occupation led to the formation of one of the three major resistance groups in the unoccupied southern zone of the country. The group, initially based in Cannes and called La Dernière Colonne, later moved to Clermont-Ferrand, subsequently changing its name to Libération-Sud.



Emmanuel d'Astier de La Vigerie played a central role in engaging the support of General de Gaulle for a new international cancer research agency.

EMMANUEL D'ASTIER DE LA VIGERIE – LIBERATION FROM THE BURDEN OF CANCER

It is no exaggeration to say that Emmanuel d'Astier de La Vigerie was a major public figure in the second half of the 20th century in France. Intriguingly, however, there seems to be little awareness of his key role in the creation of IARC. Of the several books written by or about d'Astier, none mention this episode. Perhaps this is because after his early engagement the baton was passed to other players, notably Antoine Lacassagne and Eugène Aujaleu, who took the initial idea and ran with it. Nevertheless, it is hoped that the current volume will shine a light on the remarkable legacy of d'Astier's initiative, whereby he built on the original impetus from Yves Poggioli.

D'Astier was a man who fundamentally had hope in humanity, a man who believed in people. He was also a man of action. Indeed, he spoke of ideas being insufficient if divorced from action. This resonates with his compassionate response to the letter from Poggioli and his direct approach to the head of state for a solution.

D'Astier was born on 6 January 1900, the youngest of eight children. It seems fair to say that he first found his purpose during the Nazi occupation of France in 1940. D'Astier had an overwhelming conviction to restore the dignity of France, and he turned that idea into action by creating the resistance movement Libération-Sud, along with Édouard Corniglion-Molinier (in La Dernière Colonne), Jean Cavallès, and Lucie and Raymond Aubrac, among others. Bernard (d'Astier's undercover name) would later say that the friendships he made during that period could never be matched.

While the resistance movement would be the pivotal period in the life of d'Astier, first he had to free himself from his addiction to opium. Here again one sees a remarkable strength of character as he locked himself into a hotel room alone for several days until the desperate cravings had passed. He would later recount that having survived that pain, he had an inner confidence that he would not divulge information, even under the most severe coercion, should he ever be captured.

D'Astier first met General de Gaulle in mid-May 1942 in London. It was during a later visit to the British capital that he wrote the lyrics for the iconic song "La complainte du partisan". After the war, with the continued publication of the newspaper *Libération*, he had support from and associations with the French Communist Party. In 1950, d'Astier was one of the signatories to the Stockholm Appeal calling for an absolute ban on nuclear weapons. After the war, President de Gaulle invited him to be the French ambassador to the USA. It says something of d'Astier's

strength of character and independence that he refused and focused on his writing, journalism, and a decade-long term as a far-left deputy for Ille-et-Vilaine in the French Senate.

In detailed interviews, d'Astier acknowledged the impact on him of closing his newspaper *Libération* at the end of 1964, describing himself as being at a “crossroads” and speaking of the “large hole” left in him by the closure. The proposal for an international agency may have been one of a series of creative ideas sparked by his search for new causes and meaning. The closure of *Libération* was about one year after the initial approaches to de Gaulle, but it would certainly have been weighing on d'Astier over that period. What is known is that on 23 October 1963, just two weeks before the open letter to de Gaulle on 7 November, d'Astier had received a friendly and personal letter from de Gaulle commenting on his most recent book (*On Stalin*). In the 1960s, d'Astier was also to unexpectedly call for voters to support de Gaulle in elections. Therefore, the relationship between the two men was most certainly alive and rather positive during this time.

After the closure of *Libération*, d'Astier had fresh projects afoot. He launched a new publication, *L'Événement*, notably with the participation of a young doctor called Bernard Kouchner, who would later establish Médecins Sans Frontières and would also serve as French Minister of Health. But d'Astier was to reach his widest audience by presenting a 15-minute weekly television show dealing with current affairs in the mid-1960s. D'Astier died of a myocardial infarction in 1969. Browsing through photographs of d'Astier, one is struck by the number in which he is seen smoking a cigarette. Sadly, he succumbed to the consequences of that habit, one of the risk factors for cancer to interest IARC throughout its history.

D'Astier was appointed Compagnon de la Libération, as were two of his brothers, Henri and François, although they each arrived there by different routes. On his own journey, somewhere along the way, in what may have been a mere footnote for this remarkable man, d'Astier lit the flame that has burned brightly in the form of IARC for the past 50 years.

D'Astier used his journalistic background to give shape to *Libération-Sud*, distributing tracts calling on the population to resist both the occupying forces and the Vichy government. This dangerous activity evolved into the production of the underground newspaper *Libération*. The first edition appeared in early 1941, and publication continued after the war until November 1964. This was the newspaper that the grieving man wrote to, acknowledging that d'Astier used *Libération* to fight for political causes and peace but challenging him: “What are you doing against cancer?” D'Astier later wrote of how the letter weighed heavily on him. The spirit of resistance was to turn its sights on a new enemy.

If this correspondence was one key element leading to the proposal of d'Astier to create an international cancer agency, another was certainly his wartime connections. *Libération-Sud* was part of the eventual unified French resistance movement, which evolved into the National Council of the Resistance (Conseil National de la Résistance). In this unification process, d'Astier met with Jean Moulin (later captured by the Gestapo and imprisoned and tortured in Lyon), the emissary of General Charles de Gaulle, in exchanges that, famously, were not without disagreement. D'Astier subsequently participated in the evolving leadership coalescing around de Gaulle, meeting with him in both London and Algiers. These activities opened doors for access

to other political leaders, including a meeting with Winston Churchill in which d'Astier forcefully made the case for the United Kingdom to provide arms for the French resistance. In 1944, d'Astier briefly served as Minister of the Interior in the provisional French government.

Calling on the president

Given d'Astier's direct involvement with de Gaulle from the earliest stages of the war, it is perhaps no surprise that he looked to the president to champion the idea of an international effort to combat cancer. The prior relationship opened doors that might otherwise have remained closed. D'Astier made two documented approaches to de Gaulle – the first alone, and the second through an open letter with the support of 12 leading French public figures (see “Co-signatories to the open letter”).

The first meeting, in July 1963, appears to have elicited limited interest from de Gaulle. D'Astier said, “De Gaulle listened. I don't know if he heard me.” The exception was when d'Astier presented the big idea to fund the initiative, as proposed by Poggioli: an appeal to the major nuclear powers to donate a small percentage of their defence budgets to the new international agency. De Gaulle raised a heavy eyelid and asked a few questions. He did not say yes or no. D'Astier left feeling naive and without much hope.

The second approach revolved around the open letter, which was delivered to the Élysée Palace on 7 November 1963, with copies to the embassies of the Soviet Union, the United Kingdom, and the USA. It was signed by d'Astier and 12 co-signatories (two unnamed people had refused to join the list) from diverse fields of expertise. Some of these individuals were also received by de Gaulle at the Élysée. The co-signatories included the noted cancer expert Antoine Lacassagne, who had retired from the Radium Institute in Paris but was president of the French League Against Cancer (see “French friends – Antoine Lacassagne”). Indeed, it was after discussions with Lacassagne and a cancer biologist, Marcel Bessis, that the letter was formulated. D'Astier noted that the project took shape at the end of a “summer of rotten weather”. It is true that the summer in France was unseasonably cold and wet that year – perhaps the additional time indoors helped the planning process.

CO-SIGNATORIES TO THE OPEN LETTER

These 12 leading French public figures from different disciplines co-signed the open letter of Emmanuel d'Astier de La Vigerie to General de Gaulle:

Louis Armand (Engineering)
Pierre Auger (Physics)
François Bloch-Lainé (Finance)
Ambroise-Marie Carré (Clergyman)
Jean Hyppolite (Philosophy)
Antoine Lacassagne (Oncology)
Charles Le Corbusier (Architecture)
Pierre Massé (Civil Engineering)
François Mauriac (Journalism)
Francis Perrin (Physics)
François Perroux (Political Economy)
Jean Rostand (Biology)

ACTUALITÉS MÉDICALES

**Pour développer la lutte contre le cancer
des personnalités françaises lancent un appel
en faveur d'une institution internationale
de recherche pour la vie**

Des savants, des écrivains, des sociologues, ont lancé un appel pour que les Etats-Unis, l'U.R.S.S., la Grande-Bretagne et la France assurent le financement d'une institution internationale de recherche pour la vie. En voici le texte, qui, en France, revêt la forme d'une requête au président de la République :

« Les soussignés demandent aux gouvernements des grandes puissances, qui actuellement reconnaissent la nécessité de la coopération internationale pour résoudre certains problèmes humains, de faire un geste immédiat et raisonnable au profit d'une stratégie universelle pour la vie. Il s'agit de mettre tout en œuvre pour parvenir à une mobilisation contre un des plus grands fléaux qui pèsent sur l'humanité : le cancer.

« Malgré certains succès thérapeutiques déjà importants, il n'y aura pas de victoire décisive sur le cancer tant que ne seront pas déterminés la nature du mal et le mécanisme de sa production. La victoire sur le cancer sera une grande victoire de l'homme.

« Un prélèvement dérisoire sur le budget des grandes puissances permettrait de mettre sur pied une institution internationale de lutte pour la vie, sous le contrôle effectif des organismes qualifiés de l'O.N.U. et des savants cancérologues les plus incontestés.

« Les soussignés soulignent qu'une réduction d'un demi pour cent sur les budgets militaires des Etats-Unis, de l'U.R.S.S., de la Grande-Bretagne et de la France (réduction qui ne saurait modifier l'équilibre des puissances et qui pourrait être éventuellement con-

sentie par d'autres puissances militaires) permettrait de multiplier par milliers le nombre des laboratoires, des chercheurs et des expériences. Ainsi seraient dégagés les moyens d'une stratégie universelle de la recherche sur la vie. Il ne suffit pas de congrès, de communications, de rencontres de discipline à discipline ; il faut un centre où puisse s'élaborer cette stratégie universelle qui s'impose.

« A l'institution serait confiée par ailleurs la tâche d'informer dans un langage simple, mais très exact, des progrès accomplis dans la recherche. L'opinion mondiale serait ainsi conduite à participer à une recherche et à un combat qui la concernent.

« Si les quatre chefs d'Etat des puissances désignées consentaient ce prélèvement dérisoire, le terme d'une victoire sur le cancer pourrait être avancé de nombreuses années.

« Nous nous adressons à la plus haute autorité de notre pays pour qu'elle donne en cette matière l'initiative à la France. »

Cet appel a été signé par MM. Louis Armand, Emmanuel d'Astier, Pierre Auger, François Bloch-Lainé, R.P. Carré, Jean Hyppolite, Antoine Lassaragne, Charles Le Gorbussier, François Mauriac, Pierre Massé, Francis Perrin, François Perroux, Jean Rostand

This open letter called for a “derisory” 0.5% of the military budgets of France, the Soviet Union, the United Kingdom, and the USA to be invested in an international cancer institution under the auspices of the United Nations and engaged in a “fight for life”. The levy would not change the balance of military power, it was argued. The letter to de Gaulle also specified the insufficiency of conferences, communiqués, or interdisciplinary meetings; rather, a centre was needed where this universal strategy could be realized. There was positive press coverage of this proposal for a common international effort against cancer – “one of the greatest scourges weighing on humanity”, as the letter put it. Here, one imagines that d’Astier’s press contacts were brought into useful play. Typical was the *New York Times* headline of Friday 8 November 1963: “Use of Arms Funds on Cancer Is Urged”.

The open letter to de Gaulle made little attempt to veil military parallels in this period of postwar reflection, arguing that if the heads of the four designated powers agreed to this proposal, then “the victory over cancer could be advanced by many years”. Undoubtedly the pacifist was appealing to the general through analogies to wartime, when earlier cooperation might have saved many lives. A later press report, from October 1964, supports this view, with the French

A copy of the open letter to de Gaulle, published on 8 November 1963.

Minister of Public Health and Population, Raymond Marcellin, mentioning that a peaceful cooperation among the major world powers could create an atmosphere favourable towards atomic disarmament of all nations. The letter was certainly about cancer, but it was also about disarmament and peace.

In fact, a more general backdrop of antinuclear sentiment is discernible behind the positive proposal for an international cancer centre. For example, Poggioli initially contacted d’Astier because of his links to the World Peace Council, an organization initiated by the Soviet Union to promote peace campaigns around the world.



Antoine Lacassagne was a leading figure in the French cancer community in the 20th century, after originally receiving his medical training in Lyon.

FRENCH FRIENDS – ANTOINE LACASSAGNE

Born in the Loire in 1884, Antoine Lacassagne was undoubtedly one of the most influential of the 12 French co-signatories who joined Emmanuel d'Astier de La Vigerie in sending the open letter to General de Gaulle in November 1963. Indeed, Lacassagne was the only cancer expert among the 13, and in a subsequent French newspaper article d'Astier spoke of discussions with Lacassagne before composing the letter to de Gaulle. No doubt the nascent ideas of d'Astier were complemented by the technical expertise and experience of the highly respected Lacassagne.

Lacassagne stayed involved as the idea took form, and he was present at the first of the government meetings, in December 1963, where the idea of a new cancer research organization was really developed. While celebrating his 80th birthday, he served as a vital link between the French government and the academic conference organized by UICC in Stockholm in 1964. Lacassagne appears to have walked this particular tightrope between the scientific and political worlds with some considerable aplomb.

There were strong links to Lyon as well. No evidence has been unearthed to say that Lacassagne's loyalty to Lyon played a role in the selection of the city for the new IARC headquarters, but it is fair to speculate that he would have supported the idea. In fact, Antoine Lacassagne's father was a professor of legal medicine at the Faculty of Medicine and Pharmacy in Lyon. Antoine, in turn, was a doctor of medicine and intern in the Lyon hospitals. He stayed in Lyon until his mentor, Claudius Regaud, moved to the Radium Institute in Paris, alongside Marie Curie, and called

Antoine to join him. After serving in the medical corps in the First World War, he would spend the rest of his career at this famous centre, building on his training in pathology and playing a pioneering and leading role in radiobiology and X-ray treatment of cancer. He was eventually succeeded by Raymond Latarjet and upon retirement became president of the French League Against Cancer, a position he occupied until his death in 1971.

It is perhaps notable that after his retirement in 1954, Lacassagne was one of the invitees to the first conference of the Pugwash Movement, working for peace and against weapons of mass destruction. The proposal to redirect military funds towards cancer research must have resonated deeply with Lacassagne, as it did with other key players in this new venture, including Yves Poggioli, d'Astier, and Alexander Haddow.

The first president of the World Peace Council was Frédéric Joliot-Curie, a physicist who had worked on the nuclear chain reaction before the war and was married to Irène Curie, the daughter of Marie Curie. At the World Peace Council, Joliot-Curie worked with d'Astier. Both were recipients of the Stalin Peace Prize (later renamed the Lenin Peace Prize), the Soviet equivalent of the Nobel Peace Prize. Joliot-Curie, who died in 1958, had close links with the nuclear physicist Pierre Auger, who was later to sign the open letter to de Gaulle along with d'Astier.

REPLY FROM GENERAL DE GAULLE

General de Gaulle responded within two days to the open letter from d'Astier and his co-signatories.

Mon cher Maître,

L'idée de promouvoir la recherche sur le cancer au sein d'une institution internationale procède d'une inspiration généreuse et je considère comme souhaitable que la France s'y intéresse.

Il me paraît, en effet, conforme à ses traditions qu'elle s'engage dans une œuvre où se retrouve une triple vocation : la coopération entre les peuples, le progrès de la condition humaine et l'avancement des sciences.

Aussi ai-je confié au ministre de la santé publique le soin de prendre toutes les initiatives nécessaires à cet égard.

Je vous demande de le faire savoir à toutes les personnalités signataires avec vous du message qui m'a été adressé et vous prie de croire, mon cher Maître, à mes sentiments fidèlement dévoués.

Ch. de Gaulle

My dear Sir,

The idea of promoting cancer research in an international institution draws on a generous inspiration, and I consider it desirable that France participate in it.

It seems, in fact, consistent with its traditions that France should engage in a work where three aspirations can be found: cooperation between peoples, the improvement of the human condition, and the advancement of science.

I have therefore asked the Minister of Public Health to take all necessary initiatives in this regard.

May I ask you to make this known to all the public figures who co-signed with you the message that was sent to me, and I beg you to accept, my dear Sir, the assurances of my deepest respect.

Ch. de Gaulle

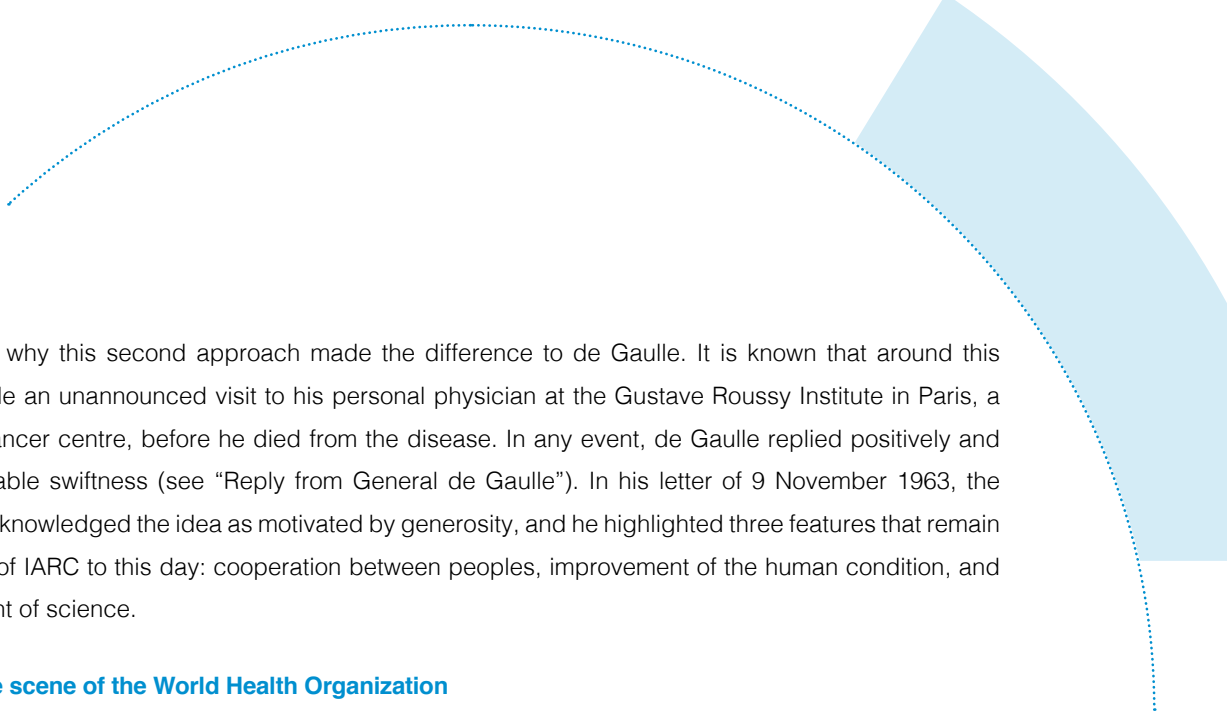

It is unclear why this second approach made the difference to de Gaulle. It is known that around this time he made an unannounced visit to his personal physician at the Gustave Roussy Institute in Paris, a specialist cancer centre, before he died from the disease. In any event, de Gaulle replied positively and with remarkable swiftness (see “Reply from General de Gaulle”). In his letter of 9 November 1963, the president acknowledged the idea as motivated by generosity, and he highlighted three features that remain at the heart of IARC to this day: cooperation between peoples, improvement of the human condition, and advancement of science.

Entry on the scene of the World Health Organization

On 11 November, four days after the publication of the open letter, Marcellin, the responsible French Minister, was on the telephone to the Director-General of the World Health Organization (WHO), Marcolino Gomes Candau. Marcellin requested a meeting within 48 hours in Paris – a meeting that took place on 13 November. From a modern-day perspective, one can only look with wonder on such pace and decisiveness. There is anecdotal evidence that the call from Marcellin to Candau came with the message to meet anywhere, anytime, to discuss a project for a cancer institute funded at the level of about US\$ 1 million per day. Marcellin also contacted the Federal Republic of Germany and Italy, informing them of de Gaulle’s desire to see them join this venture. One can appreciate the idealism behind a cooperative health-oriented venture between the Federal Republic of Germany, France, Italy, the Soviet Union, the United Kingdom, and the USA less than 20 years after the end of the Second World War.

Marcellin delegated the follow-up to his Director-General of Public Health, Eugène Aujaleu, who was present at that first meeting with Candau (see “French friends – Eugène Aujaleu”). Aujaleu would end up playing a major role in the creation of IARC. By chance, he had also been in Algiers when the Allies arrived in 1942 and as a result became responsible for public health within the provisional French government. After the liberation, Aujaleu was nominated to the role of Director of Social Hygiene within the Ministry of Health, and he represented France at WHO from the late 1950s until the early 1980s. This experience at WHO no doubt helped him in piloting the idea of a new cancer agency through the complexities of the WHO administrative procedures. Indeed, it is Aujaleu who chaired the preparatory meetings before consideration of the plans by the World Health Assembly.

In retrospect, one is struck by the remarkable flurry of activity and momentum, born perhaps of broad alignment of two fine ideals: the desires to fight for peace and against cancer. At heart, one can detect a humanitarian response to a recognized burden on the human condition. There was a natural justice in reducing the resources assigned to one perceived scourge to increase those available to tackle another. However, this idealism was soon to meet the twin pillars of bureaucracy and self-interest, with a risk that the project would be abandoned or so watered-down as to be hardly noticed.

FRENCH FRIENDS – EUGÈNE AUJALEU

Eugène Aujaleu was born in 1903 in the Tarn and Garonne. Having studied medicine in Toulouse, he focused on infections and was appointed to a chair in epidemiology at the Val-de-Grâce Hospital in 1936. At the outbreak of war, he directed the services of hygiene and epidemiology of the French Armed Forces. Finding himself in Algiers as the Allies landed, he played a major role in establishing the health services in the liberated regions, resulting in 1943 in his appointment to head the Public Health and Assistance Services in the provisional French government, under de Gaulle and alongside d'Astier.

Aujaleu appears repeatedly in the transformation of IARC from idea and idealism to reality. He was “the man from the Ministry” who used the systems and processes of the World Health Organization (WHO) to good effect, leading to resolution WHA18.44 in May 1965. He was the primary contact for the discussions about IARC within the Ministry of Public Health and Population, where he had been named Director of Social Hygiene in 1944. In 1956 he became the first Director-General for Health, contributing to major reforms in medical education and the creation of the French university teaching hospitals.

Aujaleu also had a foot firmly in WHO in his role as representative of France from 1948 to 1982, which was recognized by awarding him the Léon-Bernard Foundation Medal. In fact, it was Aujaleu who presented the case for the new cancer agency to the World Health Assembly and, following that success, it is no surprise that he was the chair of the first IARC Governing Council meeting, in September 1965. In the mid-1970s, he appears again, this time bringing clarity to the different evolving roles of IARC and WHO in relation to cancer research and control, writing an important report on the topic in 1977. Aujaleu was the first Director-General of the French Institute of Health and Medical Research (INSERM), from 1964 to 1969, a position he therefore took up over this period of IARC becoming a reality and establishing its home on French soil.



Eugène Aujaleu played a central role in piloting the creation of a new cancer research agency through the administrative hurdles of national governments and WHO. Here, Aujaleu (right) is pictured with former WHO Director-General Hiroshi Nakajima.

FROM CONCEPTION TO BIRTH – NOVEMBER 1963 TO MAY 1965

The 18 months from the time of the open letter to de Gaulle in November 1963 through to the adoption of a resolution to create IARC at the World Health Assembly in May 1965 was a period when idealism met pragmatism. Concerns were voiced as different scientific players, both within France and further afield, considered the potential impact of a new, well-funded international organization, and governments considered the proposed level of financing. Various suggestions for the new organization were formulated. These included the idea of an institution that would coordinate global research by sharing out research tasks internationally, or would serve as a conduit for distribution of funds to existing research institutes.

No doubt some of the concern among the cancer research community in France and elsewhere resulted from a chronic lack of funding within existing centres. The United States National Institutes of Health (NIH), for example, was causing concern as it reduced its spending on health research abroad; in 1963, the total NIH expenditure in more than 50 countries amounted to US\$ 13.5 million. Throughout, one can sense an inherent tension between wanting to capture the potential benefits of a (relatively) massive influx of much-needed funding for cancer research and wishing to avoid the creation of a new organization that would be the sole or major beneficiary of those funds. Linked to this was the fear that such a well-funded centre would draw all the best researchers away from national institutes.

The World Health Organization

WHO was taken by surprise by the scale of the French proposal and had to consider how this might affect the ongoing planning of its own research activities. No doubt the initial contact between the French president and the WHO Director-General was vital to the explicit support that emerged quite early in the process. Furthermore, history reveals a close working relationship and mutual appreciation between Marcellin and Candau.

In parallel, WHO was going through “a radical reappraisal” of its role in research. It so happened that in the second half of November 1963, just after the open letter to de Gaulle, two crucial meetings of scientific advisers were already planned in Geneva: one to specifically consider the role of WHO in cancer (a cancer unit had been created in 1959), and another to plan a broad and ambitious World Health Research Centre with three divisions – epidemiology, biomedical research, and communications science and technology – and with a staff of about 1300 people. It is probably not insignificant that the pre-eminent British epidemiologist Richard Doll was present at both discussions.

The nascent idea of a World Health Research Centre was discussed at the Seventeenth World Health Assembly, in 1964, and more meetings took place over the following year, before a further debate at the Eighteenth World Health Assembly, in 1965. However, it became evident that given the ambition of the project, the WHO Director-General “would be frustrated in his desire” to see this new centre come to fruition.

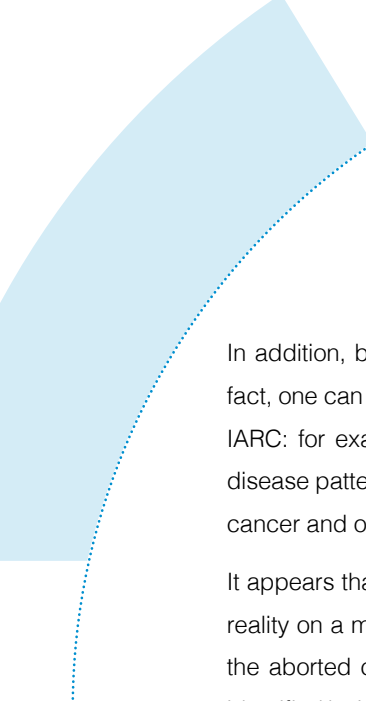

In addition, by that stage the “de Gaulle initiative” for a cancer research centre was firmly on the table. In fact, one can note many planned features for the World Health Research Centre that would later characterize IARC: for example, the division of epidemiology was to conduct laboratory research to study health and disease patterns in different countries, the biomedical division was to study mechanisms of action relevant to cancer and other major biomedical problems, and training was to feature prominently.

It appears that at the World Health Assembly in 1965, the idea of a broader health research centre became reality on a more modest scale in the form of IARC. The creation of IARC may have salvaged something of the aborted centre for the WHO Director-General while also encapsulating cancer research opportunities identified by WHO. In fact, WHO was already involved in several international studies – notably on comparisons of lung cancer in Norway and Finland, breast cancer in seven different parts of the world in relation to lactation and childbearing, and cancers of the buccal mucosa in India and the Central Asian republics of the Soviet Union – as well as prominent activities in the international classification of human tumours via a wide set of pathology reference centres globally.

Certainly, Candau must have been strongly supportive of the new cancer agency for such rapid progress to have been made through the WHO administration as well as the formal debates and resolutions at the Seventeenth and Eighteenth World Health Assemblies. Evidently, the support of Marcellin and Aujaleu was also unstinting. Strategic considerations around the creation of a new organization seem to have coalesced with a vision for the scope of activities of such an entity. Those in influence were handed not just an outline sketch of a new structure but a painting of what it would achieve if realized.

Another international cancer organization

There was already an international cancer organization, which had been in existence since 1933: the Union Internationale Contre le Cancer, or in English, the International Union Against Cancer (UICC, now called the Union for International Cancer Control). It was not unexpected, therefore, that UICC also had to consider the potential impact of the French initiative.

The first to act was the eminent professor Alexander Haddow, director of the Chester Beatty Research Institute in London and president of UICC from 1962 until 1966. Haddow wrote supportive letters to the heads of state of the five countries considering de Gaulle’s proposal, while pointing out the need to consider the idea in the light of current and planned activities by existing organizations. Haddow informed de Gaulle about the letters and sent him, as an example, the one written to United States President Lyndon B. Johnson. De Gaulle’s reply to Haddow is particularly striking because, while he acknowledged the efforts of UICC and others, he focused on the need of researchers to work together if the victory over cancer is to be won, referring to “a union of research workers that extends beyond national frontiers”. He clearly wanted more than a loose exchange of information among cancer researchers. This recognition was insightful and influential as the conception of an international organization gave birth to IARC.

UICC continued to debate, both internally and externally, the shape and form of any new organization, with varying degrees of enthusiasm. In late 1963, Haddow expressed his anxiety at how things were developing to both Candau and Marcellin. There seem to have been two major concerns, aside from consideration of the direct impact on UICC activities. The first was that WHO would not be the best home for a research centre, both because of the heavy bureaucracy and because of its predominantly public health orientation (UICC initially considered the priority for the new centre to be basic research). The second was that as the scale of the likely investment began to shrink from the original bold vision of the levy on defence budgets, UICC favoured the strengthening of existing research efforts rather than the creation of a new but small centre, which might be ineffective.

To develop a purely scientific view, UICC organized an international conference in Stockholm on 7–9 September 1964 and invited world-leading cancer experts to consider alternatives by which the new organization might take form. This gave rise to some tension with WHO, possibly creating the impression of a battle for control of the initiative. Haddow, in his opening remarks and commenting on the original vision of the French initiative, stated: “As a Scotchman the idea appealed to me immensely, offering great benefits for no more expenditure than we had already agreed to spend. Its failure thus far I greatly regret as a person, since in England I am much involved with questions of peace and disarmament; but in practice this idea or ideal certainly appears to be dead.”

LE GÉNÉRAL DE GAULLE

Monsieur le Président,

Je vous remercie d'avoir bien voulu m'exprimer les espoirs que vous mettez dans les récentes initiatives que j'ai cru devoir prendre au nom de la France.

La lutte contre le cancer me semble être l'une des missions les plus hautes qui puisse s'imposer aux chercheurs de notre temps. Je n'ignore pas les généreux efforts de l'Union Internationale dont vous assurez la présidence. Je n'ignore pas les brillantes recherches dont vous avez honoré la Grande-Bretagne. Il me semble, cependant, que la victoire sur le cancer ne pourra être assurée que par une union des chercheurs par de-là les frontières. Dans cet effort commun, je vous remercie de l'aide que vous nous apportez.

Veillez croire, Monsieur le Président, à mes sentiments les plus distingués et les meilleurs.



Monsieur Alexander HADDOW,
Président International Union
Against Cancer,

President de Gaulle wrote to the president of UICC, emphasizing the need for something more from the new initiative than was available in existing organizations.



Leading cancer researchers discussed the "French initiative" at the UICC conference in Stockholm on 7-9 September 1964.

Haddow, a participant in numerous disarmament initiatives, was visibly disappointed by the rupture of the link between reduced military budgets and increased cancer research funding. This is consistent with the recollection of Jean-Francois Delafresnaye, then the UICC chief executive, who remembers Haddow having forcefully voiced displeasure at the proposal for a much scaled-down initiative during the second meeting of the participating governments, held seven months earlier in Paris; UICC was not invited to subsequent planning meetings by the participating governments.

Varying degrees of freedom

In retrospect, one can trace two different visions during this period. The first one, among the cancer research community, was focused more on what a new organization might do and leaned towards the creation of a completely independent organization, either intergovernmental or nongovernmental, outside of WHO. The second vision, among the five interested governments in liaison with WHO, was focused on how to create the new organization as intergovernmental but in relations with WHO, either as an arm of the organization or linked via a signed convention, allowing the new organization to benefit from the administrative infrastructures and avoiding the need for a completely separate development. In retrospect, the fact that the initiative was at the very highest level in France, promoted by the French Minister, and had the personal support of the WHO Director-General, was decisive. Ultimately this position within WHO and the broader United Nations family has been at the root of IARC's unique contribution, providing an independence to conduct and coordinate international collaborative research and a status, as the cancer agency of WHO, to lend impact to its findings and pronouncements.

Aujaleu, working on the WHO model, was concerned, however, as to how decisions would be made on research projects if approval was needed by the 100 or so WHO Member States, and whether cancer might

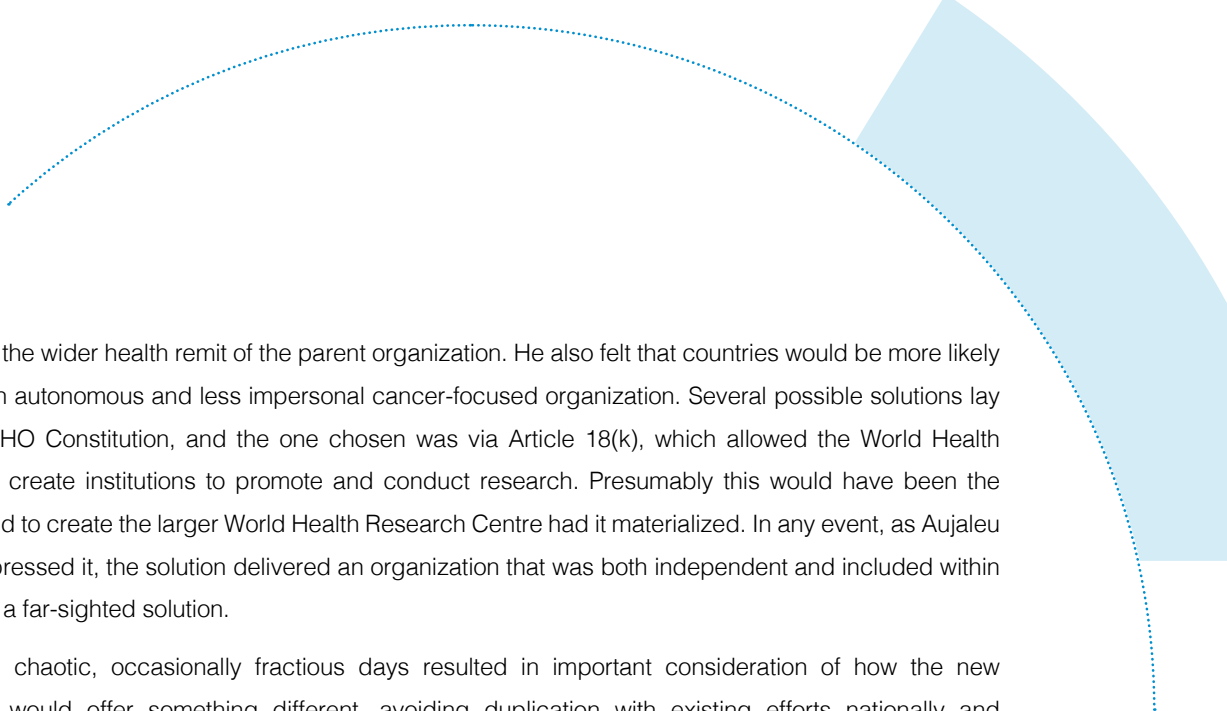

be diluted in the wider health remit of the parent organization. He also felt that countries would be more likely to support an autonomous and less impersonal cancer-focused organization. Several possible solutions lay within the WHO Constitution, and the one chosen was via Article 18(k), which allowed the World Health Assembly to create institutions to promote and conduct research. Presumably this would have been the route selected to create the larger World Health Research Centre had it materialized. In any event, as Aujaleu perfectly expressed it, the solution delivered an organization that was both independent and included within WHO. It was a far-sighted solution.

These early, chaotic, occasionally fractious days resulted in important consideration of how the new organization would offer something different, avoiding duplication with existing efforts nationally and internationally. UICC, in turn, was to become one of IARC's long-standing and valued collaborators in several areas, not least capacity-building.

Towards a resolution

Two key technical meetings were held in Paris before the World Health Assembly in June 1964 to formulate plans for the new organization. The first, on 17–18 December 1963, was attended by representatives from the Federal Republic of Germany, France, the United Kingdom, and the USA (the Soviet Union was invited but did not attend) and by the WHO Director-General and the president of UICC. Lacassagne was present as one of the French delegation, providing the link back to the original co-signatories of the letter to de Gaulle. The meeting was called in a hurry, occurring just one month after the open letter was sent, and as a result there was relatively limited time for preparation. The meeting did, however, outline areas of potential activity, including a cancer information centre, tumour classification, epidemiology, and training and support for researchers worldwide by provision of standards and resources for projects. By all accounts the meeting was preliminary in nature but positive.

At the second meeting, held on 27–28 February 1964, the same participants as well as observers from the United Nations Educational, Scientific and Cultural Organization (UNESCO) debated different governance models and drew up more detailed plans, which were eventually summarized in a document to the World Health Assembly. By this time governments had had the time to formulate their positions, and some of these had become less than wholehearted in their support. Interestingly, one sees emerging a name, the “World Research Agency for Cancer”, and the idea of Governing and Scientific Councils with a Secretariat, which would include technical experts and operate in close liaison with WHO. The proposed plans were remarkably similar to the final governance structure of IARC. The Governing Council was to be the “supreme authority of the Agency”.

It was also at this February meeting that the crucial issue of budget was considered in detail for the first time. Sadly for cancer research, military leaders were going to sleep a little easier in their beds, even as the war in

Viet Nam waged. A calculation across the six countries (the Federal Republic of Germany, France, Italy, the Soviet Union, the United Kingdom, and the USA) of 0.5% of military expenditure yielded the stunning annual sum of US\$ 396 million (presumably the origin of the "US\$ 1 million per day" budget that Marcellin had relayed to Candau). Of this sum, US\$ 265 million was to come from the USA and about a tenth of that amount from the United Kingdom. It is perhaps not surprising, therefore, that a counterproposal came from the USA, delivered by the head of the delegation, Assistant Surgeon General James Watt. This included a budget based on a flat rate of US\$ 100 000 per country, well short of an annual budget of US\$ 1 million and, somewhat symmetrically, less than 0.5% of the original vision. It is here that Haddow reportedly used strong language to emphasize that the American proposal bore no resemblance to the idea put forward by de Gaulle. To the surprise of some, the French delegation nevertheless agreed to use the American draft governance document, including the budget, as a basis for further discussion.

<u>1963 Defence Budgets</u>		<u>rate</u>	<u>1/2 % in US \$</u>
<u>TOTAL Budgets in home</u>	<u>1/2 %</u>	<u>\$</u>	
USA \$ 53,000,000,000	53,000,000	—	265,000,000
USSR R. 13,888,808,000	R. 13,888,808	.90	77,160,044
U.K. £ 2,100,968,350	£ 2,100,968	2.80	29,413,558
Germany DM. 3,902,284,900	DM 3,902,284	4.00	4,877,856
Italy L. 886,328,326,000	L 886,328	621.00	7,136,299
FRANCE F. 11,811,346,577	F 11,811,346	4.90	12,052,395
			<u>3,956,640,152</u>
			<u>395,640,152</u>

A post hoc analysis of the financial model of 0.5% of defence budgets redirected to cancer research (prepared by A.G.B. Sutherland, head of the Unit of Administration and Finance at IARC in the late 1960s and early 1970s).

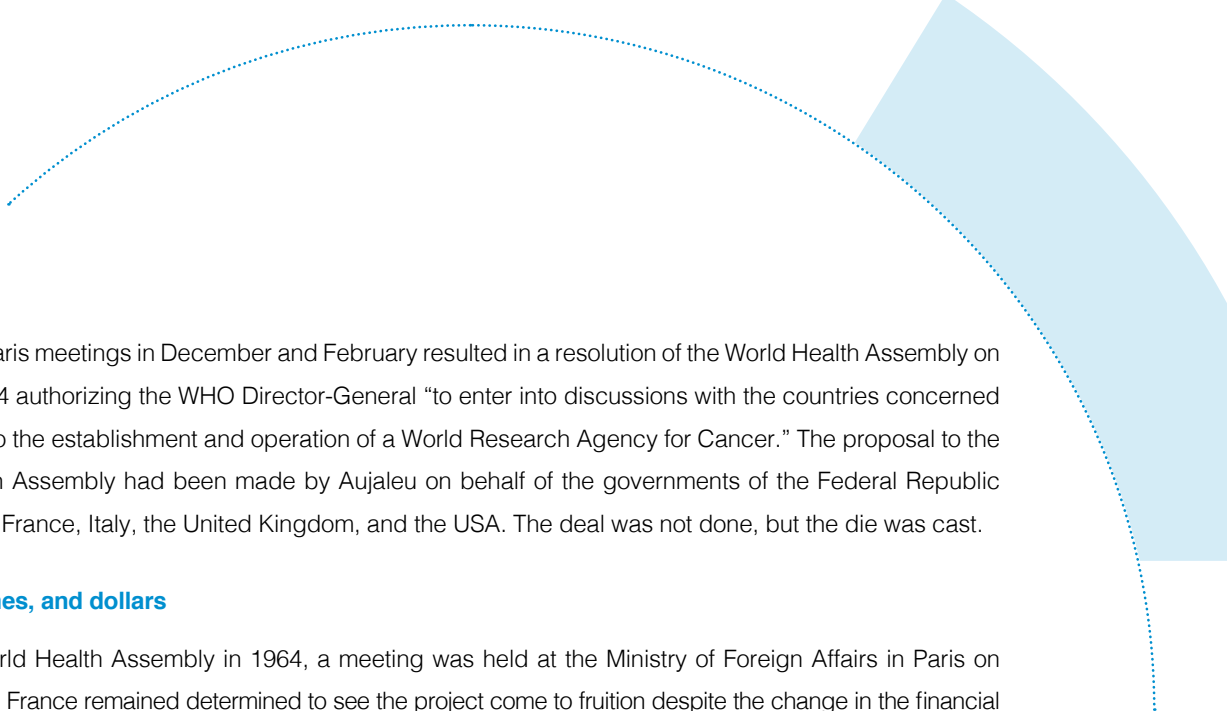

These two Paris meetings in December and February resulted in a resolution of the World Health Assembly on 19 June 1964 authorizing the WHO Director-General “to enter into discussions with the countries concerned with a view to the establishment and operation of a World Research Agency for Cancer.” The proposal to the World Health Assembly had been made by Aujaleu on behalf of the governments of the Federal Republic of Germany, France, Italy, the United Kingdom, and the USA. The deal was not done, but the die was cast.

Places, names, and dollars

After the World Health Assembly in 1964, a meeting was held at the Ministry of Foreign Affairs in Paris on 27 July 1964. France remained determined to see the project come to fruition despite the change in the financial model. From this meeting one can see the first notes about the possible location for the new organization. Several interested French cities had come forward to the Ministry, but two favourites emerged: Vaucresson, on the outskirts of Paris, near the Raymond Poincaré Hospital in Garches, and Lyon, “because of the proximity to Geneva, where WHO is located.” Lyon was ready to provide an entire building in the Brotteaux district as a temporary solution and was even able to make available “within 48 hours” a large office in the wings of the City Hall itself. Although further preparatory meetings did take place in Paris on 29 September–2 October 1964, the next series of detailed discussions was held in Lyon the following year, perhaps a further indication that the home of the new organization was to be this former capital of Roman Gaul, once known as Lugdunum.

The intergovernmental meetings in Lyon comprised three sessions, on 16–18 February 1965. Discussion turned back to the budget, and a prolonged debate ensued. The participants, chaired by Aujaleu, were trying to balance five individual countries paying an annual contribution of a maximum of US\$ 150 000 each with the recognition that a total of US\$ 750 000 would be a modest start indeed. In fact, the immediate concern was that the scientists tasked with advising on the new agency’s programme later the same year might consider this too small a sum to be worth turning up to discuss!

Harold Himsworth from the United Kingdom proposed one way out of the conundrum: to send invitations to 10 more countries to join the new organization, arguing that with 15 countries the total annual budget would be about US\$ 2 million. Candau suggested that this sum should be adopted as a starting point to aid the scientific planning, and this was eventually the agreed position from the meeting. There was also discussion as to whether to seek additional countries in time for the looming World Health Assembly. The group did not wish to be exclusive but recognized the difficulties for countries to take decisions in the short time that remained. There is an interesting reference to the Netherlands, present at the meeting, which had been deliberating participation for five months. The Netherlands would eventually become an IARC Participating State two years later.

The discussion of names also continued, no doubt partially influenced by the different mother tongues of the discussants. The name “World Research Agency for Cancer” had disappeared. The proposed French



version of the name now included “centre international”, with the English translation, used by the Brazilian WHO Director-General, being literal: “international centre”. Himsworth from the United Kingdom made a case for “international agency” because this would be more expansive, the word “centre” implying “activities in one place”. This concept is consistent with earlier comments from Lacassagne, who had reportedly spoken of an international institution and not an international institute, which in French would also have been more limited than the broader collaboration desired. The outcome of this debate is reflected in the difference between the names in English and French, persisting to this day, whereby both “agency” (in English) and “centre” (in French) were deemed to imply something more than work performed in a single place. This breadth was never meant to be interpreted as there being no need for a headquarters and core staff, but rather it pointed towards the anticipated degree of international participation by national scientists in the work of IARC. This principle is also illustrated by the fact that IARC Participating States should not only contribute financially but also participate in research through the collaboration of their scientists. By 19 February 1965, Aujaleu was writing letters of invitation to the first Scientific Committee meeting in which he referred to IARC by its permanent names, in both French and English.

Interestingly, one name that didn't end up associated with IARC was that of the recently assassinated United States President John F. Kennedy. The suggestion of attaching the late president's name to IARC had been made by Pierre Massé, one of the co-signatories of d'Astier's letter to de Gaulle, and also in the original letter of Haddow to President Johnson in late 1963, but does not seem to have been pursued further.

Scope of activity

The work now moved to a new phase: specifying what the new agency would do. Discussions in Lyon on 30 March–6 April 1965 were based on a series of working papers coming from meetings held earlier in Geneva: on a cancer research information centre (Working Group meeting held 3–5 February 1965), epidemiology (14–16 December 1964), pathology (14–18 December 1964), and training (undated, but at least partly drafted by Albert Tuyns, later to become one of the first IARC scientists).

The scientific advisory committee, comprising 12 outstanding cancer researchers from across the world, met on 30 March–2 April 1965, highlighting what could be learned through an international collaborative dimension and the value of training. Epidemiology was identified as a principal sphere of activity, including studies on the occurrence and patterns of cancer. It is noteworthy that the three participants in the epidemiology subgroup were Richard Doll, John Higginson, and Daniel Schwartz, who was the head of the first cancer epidemiology unit in France, at the Gustave Roussy Institute.

The Scientific Committee emphasized that epidemiologists should not work in isolation, and thus pathology was highlighted as of importance, in relation to epidemiology. There were also areas that are not today a part of IARC's work, notably comparative oncology among domestic, farm, and wild animals as well as a role in

the distribution of well-characterized animal strains and other research tools for experimental studies. The indicative budget of US\$ 2 million was considered a minimum if the new agency was to make any impact on a world scale. The budget constraints led to the scientific experts placing less emphasis on some areas, including the possibility of a global information centre on cancer research.

Immediately after the scientific meeting, the government representatives met on 3–6 April and were joined by the chair and the rapporteur from the previous days' events: Otto Mühlbock from the Netherlands and Richard Doll, respectively. The emphasis on epidemiology was supported, as was training, but the relative lack of resources directed to the cancer research information centre was not universally appreciated. The point was reiterated for the new agency to avoid duplication with national centres and to conduct research that such national centres could not accomplish. There was also a view that the agency would support research in national centres, including by funding studies. This is manifest in one form via the Collaborative Research Agreements that IARC establishes with collaborating centres across the world.

In terms of budget, France continued to fight hard for higher contributions, first arguing for US\$ 400 000 per country, based on the Scientific Committee's views, but later dropping to US\$ 200 000 in an attempt to reach consensus. In the end, agreement could only be reached on US\$ 150 000 from each of the five countries present, with the hope that more would join. A 5-year budget was set on this basis, although subsequently IARC moved to budgets set on a biennial cycle. Aujaleu "trusted the Agency would soon be endowed with funds larger than they had been able to vote at the present meeting so that the hopes raised by its creation would not give way to disappointment." There was also the intention that this "core" budget would be supplemented by additional resources for specific projects.

World Health Assembly resolution WHA18.44, of 20 May 1965, formally creating the International Agency for Research on Cancer.

WHA18.44 Establishment of an International Agency for Research on Cancer

The Eighteenth World Health Assembly,

Cognizant of Article 18 of the Constitution which provides, *inter alia*, that one of the functions of the Health Assembly shall be to establish such other institutions as it may consider desirable, with a view to promoting and carrying on research;

Considering that the Governments of the Federal Republic of Germany, France, Italy, the United Kingdom of Great Britain and Northern Ireland, and the United States of America have agreed to sponsor the creation and to participate in the functioning of an International Agency for Research on Cancer¹ in accordance with the provisions of its Statute;

Considering that many governments have expressed their interest in the creation of such an Agency; and
Considering resolution WHA17.49 of the Seventeenth World Health Assembly,

DECIDES to establish an International Agency for Research on Cancer which shall carry on its functions in accordance with the provisions of its Statute (annexed).

Aujaleu made the positive point that equal financial contributions from the different Participating States would avoid the risk of policy being dictated by a few countries that paid far more than others. A relatively small difference in scale of financial contributions among IARC Participating States has been a model retained over the past 50 years, achieving exactly the outcome anticipated by Aujaleu. Incidentally, true to its original ideal at least, France was the only country to take its initial financial contribution to IARC from its defence allocation.

The culmination of this remarkable roller-coaster ride, from a simple letter through to a proposal to the World Health Assembly for the creation of a new international agency for research on cancer, finally came to fruition in May 1965.

THE BIRTH OF IARC – MAY 1965

IARC's birthday can be considered to be 20 May 1965, when the World Health Assembly passed the remarkably brief and perfunctory resolution WHA18.44 creating an agency for international cooperation in the field of health under Article 18(k) of the WHO Constitution. Technically, however, WHO announced on 20 September 1965 that IARC had begun to function on 15 September 1965 upon confirmation by the five named Participating States (the Federal Republic of Germany, France, Italy, the United Kingdom, and the USA) of their formal agreement to observe and apply the terms of the IARC Statute, attached to the World Health Assembly resolution. IARC began to take form.

Members of the first IARC Governing Council at the meeting in Lyon, which took place on 23 and 24 September 1965.





The Soviet Union was not among the founders of IARC but was one of the countries that soon joined. Higginson shared his memories about Nikolai Blokhin and how he persuaded Nikita Khrushchev to support the Soviet Union to join the Agency. – David Zaridze, former IARC scientist

The first meeting of the IARC Governing Council took place less than a week later, on 23 and 24 September 1965, with Aujaleu as the chair, accompanied by Giovanni Canaperia from Italy as the vice-chair. At that meeting, the Soviet Union was represented because it was one of the countries, along with the Netherlands, that had taken a close interest in the planning phase.

Both Australia and the Soviet Union became

Participating States at that meeting, thus taking to seven those countries committed to IARC's development. In 1966 Israel also became a Participating State, perhaps through the participation of Isaac Berenblum from the Weizmann Institute of Science in the scientific planning meetings. The Netherlands joined shortly afterwards, in April 1967, and this group of Participating States was to steer IARC through the rest of the 1960s. By the time IARC moved into its own premises, in 1972, the number of Participating States had grown to 10; Belgium and Japan had joined, but Israel had withdrawn in 1971. The annual budget had reached US\$ 2.4 million, a little over the minimum amount envisaged seven years earlier.

The IARC Scientific Council met for the first time on 25 September 1965. The meeting was attended by a striking set of world cancer leaders, including Richard Doll, Abraham Lilienfeld, Nikolai Blokhin, and George Klein as well as Isaac Berenblum, demonstrating the importance with which this new international organization was viewed (see "The first IARC Scientific Council"). Indeed, Doll is widely known to have been approached when the discussion turned to the question of the first IARC Director, but he declined.

John Higginson took office as IARC Director on 1 July 1966 and started to build a small group of scientists around him. Among the first were Calum Muir, Albert Tuyns, Gregory O'Connor (seconded from the United States National Cancer Institute), Guy de Thé, Lorenzo Tomatis, Pavel Bogovski, and Walter Davis (from Haddow's Chester Beatty Research Institute). Higginson set many of the priorities for IARC that persist to the present day, including a firm commitment to the need for a strong interdisciplinary approach to understanding the causes and prevention

THE FIRST IARC SCIENTIFIC COUNCIL

Members of the first IARC Scientific Council, which met on 25 September 1965:

- I. Berenblum (Israel)
- N.N. Blokhin (Soviet Union)
- P. Bucalossi (Italy)
- W.R.S. Doll (United Kingdom)
- H. Hamperl (Federal Republic of Germany)
- B. Kellner (Hungary)
- G. Klein (Sweden)
- A.M. Lilienfeld (USA)
- G. Mathé (France)
- D. Metcalf (Australia)
- O. Mühlbock (Netherlands)
- P.N. Wahi (India)

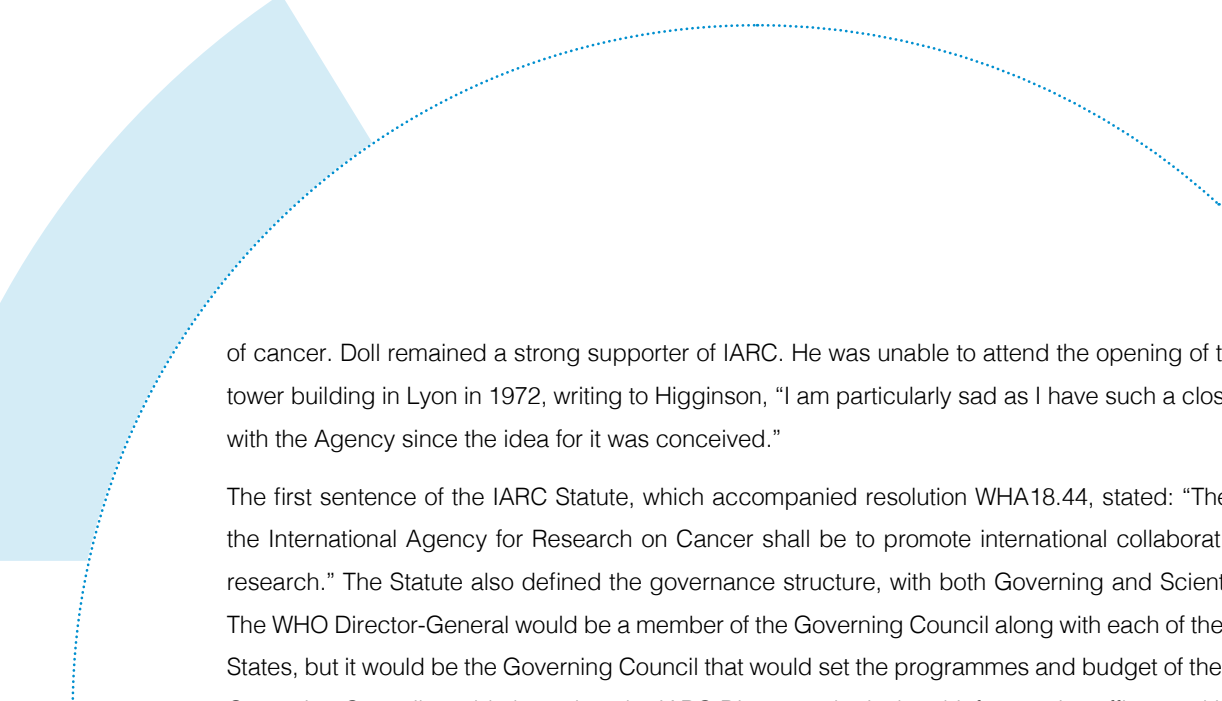

of cancer. Doll remained a strong supporter of IARC. He was unable to attend the opening of the new IARC tower building in Lyon in 1972, writing to Higginson, “I am particularly sad as I have such a close connection with the Agency since the idea for it was conceived.”

The first sentence of the IARC Statute, which accompanied resolution WHA18.44, stated: “The objective of the International Agency for Research on Cancer shall be to promote international collaboration in cancer research.” The Statute also defined the governance structure, with both Governing and Scientific Councils. The WHO Director-General would be a member of the Governing Council along with each of the Participating States, but it would be the Governing Council that would set the programmes and budget of the Agency. The Governing Council would also select the IARC Director, who is the chief executive officer and is responsible to the Governing Council, not to the WHO Director-General. The Governing Council also decides which WHO Member States may become IARC Participating States. All of this added up to IARC being an autonomous agency within WHO, open to any WHO Member State that wished to participate both financially and through the contribution of its scientific experts; this is why IARC has Participating States, rather than Member States.

Those who gave form to IARC showed great skill in achieving the right balance between complete integration within WHO and absolute independence. They wanted the best of both worlds, and their vision has proven inspired. IARC is autonomous to a remarkable degree but is still part of WHO and therefore of the wider United Nations family. This solution has also enabled IARC to enjoy a distinct individuality in its external relations, developing its own reputation as a global leader in cancer research and in turn bringing great prestige back to WHO.

As a research agency with this degree of independence, IARC has been able to investigate difficult, often politically inconvenient topics and to present the science on which others can base policy actions. The lack of interference in that research process is testament to the adherence of Participating States to the principles on which IARC was founded 50 years ago. As a consequence, all concerned within the Secretariat and on the governing bodies carry a heavy weight of responsibility to maintain those principles into the future.

A PLACE TO CALL HOME

Where would IARC be located? France was the natural host country for this new international organization, and IARC remains – with UNESCO – one of only two United Nations organizations to be headquartered in the country. Lyon was formally confirmed as the new home for IARC, according to the official journal of the French National Assembly, at the first IARC Governing Council meeting, in September 1965. In his speech at the inauguration of the IARC tower building in 1972, President Georges Pompidou made reference to the strong tradition of medicine in Lyon and the proximity to Geneva and WHO headquarters as reasons for this choice. Aujaleu also noted that the geographical separation from WHO headquarters was another element in ensuring the autonomous nature of IARC.

A letter sent by the mayor of Lyon on 28 April 1971 to the IARC Director, warning him not to reveal the exact date of the opening of the new building, to ensure that the builders would have it ready on time: "I would like to ask you not to make this date known, particularly to the architects and contractors. I will tell them that you need the buildings by the middle of May. If the exact date is revealed, these gentlemen will not hurry and the building will not be perfect to receive our distinguished guests."

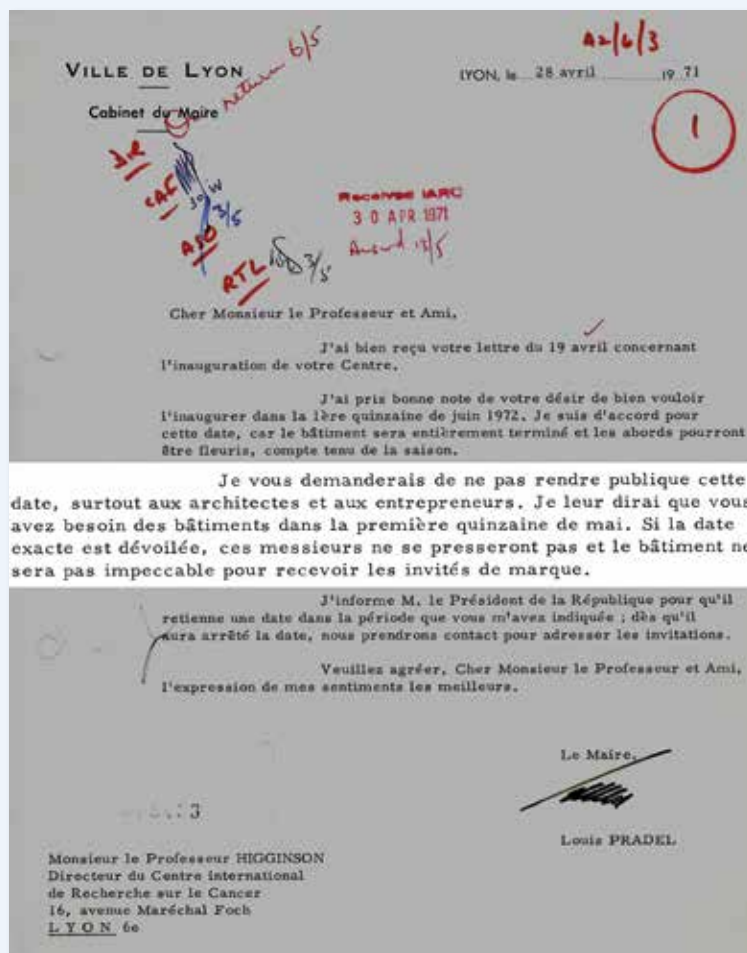

The mayor of Lyon at the time, Louis Pradel, was also strongly in favour of Lyon being IARC's host city. Pradel was Lyonnais to the core, passionately committed to the city, and served as mayor from 1957 until his death from cancer in 1976. A hospital in Lyon carries his name, while the main general public hospital is named in memory of his predecessor, Édouard Herriot; perhaps these associations are further testimony to the great importance placed in Lyon on the pursuit of excellence in medicine and science, continuing and developing to this day. Pradel was also apparently a pragmatic man who understood human nature. His letter to the IARC Director, in anticipation of the grand opening of the new IARC tower building, provides one delightful example.

George Klein was a member of the first IARC Scientific Council, which met in 1965, and he participated in the planning meetings for the new agency. Klein recalls, "The mayor of Lyon spent a surprisingly large amount of time with us. It was quite clear that he wanted the new agency there. We were clearly impressed by Lyon and supported it as the site. During the subsequent years, we were impressed by the developments – the new building in particular – and it was our feeling that we had made a good choice."

Until May 1967, IARC was hosted by WHO in Geneva. A key date in its development was the signing on 14 March 1967 of the host agreement between WHO and France, permitting IARC to set up its Lyon



Premises at 16 avenue Maréchal Foch were made available to IARC by the City of Lyon from 1967.

headquarters. The mayor made temporary accommodation available at 16 avenue Maréchal Foch, with additional offices for biostatistics elsewhere in the city centre, and the official “opening” of IARC was fixed as 22 May 1967. As promised, IARC also had access to some of the fine rooms of the City Hall in Lyon, a magnificent building dating from the mid-17th century.

By this stage discussions had already begun on new, purpose-built accommodation; Pompidou visited Lyon on 24 March 1968, when he was shown the model of the new tower building. In the meantime, the local scientific and medical community was extremely supportive: laboratories were made available in the French Institute of Health and Medical Research (INSERM) and by the Mérieux Institute, and IARC was able to rent space from the Centre Léon Bérard with the support of Roger Sohier and Marcel Dargent, the director of this renowned regional cancer centre. Prefabricated buildings were also erected on the future site of the IARC tower to provide space for the laboratories, some offices, and animal housing facilities. These two-floor “temporary” buildings were to persist for more than 20 years. Even in the late 1980s they were still being used to house a small colony of rabbits for antibody production, as well as serving as the location for the French and English language classes – frequently at the same time!

The new IARC tower certainly made a statement. Particularly in the early 1970s, the 14-floor building soared above all others in the vicinity. The architects assigned by the City of Lyon were Pierre Bourdeix and Paul Guillot, and the consulting architect for IARC was Roland Mendelssohn, chief architect of INSERM, Paris. Even today in its ageing state the building can impress: on a bright Lyon day of clear, unclouded blue skies, the concrete pillars and blue fascia lead the eye soaring upwards while the solid, square design emanates presence and reliability. The entrance hall is enhanced by the sculpture in solid mahogany by Pierre Mathieu, representing the “triumph of life over the destructive elements of the environment” – a concept befitting the work of IARC and its many partners worldwide. As a footnote, IARC’s address is 150 cours Albert Thomas, and one might note with a degree of irony, given IARC’s origins, that Thomas was French Minister for Munitions during the First World War, later to make his mark as the first director of the International Labour Office.



On 23 March 1969, French Prime Minister Maurice Couve de Murville laid the first stone of the IARC tower building.

The first stone of the IARC tower building was laid by French Prime Minister Maurice Couve de Murville on 23 March 1969, and the building was inaugurated by President Pompidou just a little over three years later, on 9 May 1972. Pompidou was accompanied by his wife and no less than five French Ministers. At the inauguration, John Gray, the chair of the IARC Governing Council, emphasized that the work of the Agency “should be planned without regard to political and national boundaries.” Pompidou spoke of the

need to remove the fear and myths surrounding cancer, and finished his address by stating, “Gentlemen, may the solidarity of mankind find in your work a broad scope of application and success.”

There were messages of support from heads of government, notably United States President Richard Nixon, who had signed the National Cancer Act the year before with the famous declaration of a “war on cancer”, and United Kingdom Prime Minister Edward Heath, a Europhile who had just led his country into the European Common Market.



President Pompidou addressing the audience at the inauguration of the new IARC tower building in May 1972. Behind him is seen the mayor of Lyon, Louis Pradel.



10 Downing Street
Whitehall

I PLEDGE THE STRONG AND CONTINUING SUPPORT OF MY COUNTRY TO ITS
IMPORTANT WORK AND WE ARE GRATEFUL TO THE GOVERNMENT OF FRANCE FOR
MAKING IT POSSIBLE FOR THE STAFF TO HAVE EXCELLENT PHYSICAL
FACILITIES IN WHICH TO CONDUCT THEIR URGENTLY NEEDED STUDIES PARA
SINCERELY PARA RICHARD NIXON PARA ROGERS

COL NIXON ROGERS

I congratulate the International Agency for Research on Cancer on the occasion of the inauguration of the new Headquarters Building so generously provided by the French Government and the City of Lyon. Her Majesty's Government, in common with the governments of the other participating states, places the greatest importance on the fight against cancer and is eager to explore all opportunities for increasing international co-operation in this field. I am confident that the new facilities inaugurated today by President Pompidou will enable the Agency to continue and expand to the best advantage its contribution to cancer research.

Edward Heath

8 June 1972

Many letters of congratulation were received from leading figures when IARC opened its headquarters in Lyon. Shown here are two examples, from United States President Richard Nixon and United Kingdom Prime Minister Edward Heath.

A GROWING CONCERN

Over time, as IARC became established, some of the floors of the tower, originally unoccupied, were filled. Further expansion came with the opening of additional buildings and facilities. In 1988 the wealthy Japanese businessman and philanthropist Ryoichi Sasakawa made a donation to permit the construction of much-needed meeting rooms. The main new meeting room was named after Her Imperial Highness Princess Kikuko Takamatsu, who was well known and respected for her philanthropic activities related to cancer research.

An additional building was erected in 1994 to house the large cohort study of nutrition and cancer (the European Prospective Investigation into Cancer and Nutrition [EPIC]; see the chapter "Nutrition, metabolism, and cancer"), which included space for the liquid nitrogen tanks filled with several million straws containing biological specimens. An interesting addition to the IARC estate was the Latarjet building, named after Raymond Latarjet, which was opened in 2000 (see "French friends – Raymond Latarjet"). The front of the building, designed by Christian Drevet during the period when Paul Kleihues was the IARC Director, is

made to resemble DNA sequencing gels, capturing a time when that technology was at the cutting edge of cancer research.

The inherent structure of the early-1970s tower building did present a problem in the early 1990s, when unacceptable levels of asbestos were discovered. The building was closed for many months as a result, while specialist teams dealt with the expensive removal of this carcinogenic substance. It also resulted in the dispersion of IARC personnel to various sites around the city, for both office and laboratory accommodation, recapturing something of the spirit of the late 1960s. Certainly the “crisis” represented another occasion when the local Lyon community proved its solidarity with the Agency and its global mission.

As evident from the opening sentences of the IARC Statute, collaboration was at the heart of the vision for the Agency. In the early years, this was also in evidence through the creation of several IARC Regional Centres, perhaps modelled on the much larger Regional Offices of WHO and a symbol of the vision that IARC should not be limited to a single physical location (see “The IARC diaspora”). IARC had such offices in Nairobi, Kenya, in Singapore, in Kingston, Jamaica, and in Tehran, Iran.

“

In the 1990s we had to evacuate the building because it was full of asbestos, which had been recognized as a carcinogenic substance. We therefore had to move to different buildings in town. It was a major operation, and I remember that very well. – Keiji Saita, former Director of Administration and Finance at IARC



Ryoichi Sasakawa (centre) was present to open the Princess Takamatsu Hall in 1988 with the IARC Director Lorenzo Tomatis (right).

FRENCH FRIENDS – RAYMOND LATARJET

Born in Lyon in 1911, Raymond Latarjet was a fiercely proud Lyonnais and a major force in cancer research in France throughout the second half of the 20th century. His father was a professor of medicine, and he came from a family of surgeons. Remarkably, his first research was on the fluctuations in atmospheric ozone and the effect of ultraviolet radiation on living organisms – this was in 1935. He would go on to pursue his doctoral studies on the effects of ultraviolet radiation, and this background was probably one reason why Antoine Lacassagne invited him in 1941 to join the Radium Institute in Paris, where he started to take an interest in cancer.

After the end of the Second World War, Latarjet spent time in Cold Spring Harbor, USA, working with Salvador Luria. He conducted studies of mutations in viruses, consequent to irradiation, and they developed the renowned Luria–Latarjet curves. In 1954 he became director of the Biology Section at the Curie Foundation-Radium Institute, taking up the reins from his mentor, Antoine Lacassagne.

In 1959 Latarjet had a significant influence on the future of molecular biology in France through his participation in an advisory group on science reporting directly to the French president. His son, Francis, remembers him recounting many times a meeting in Paris with de Gaulle where there were 12 experts from many different leading areas of science, each given 5 minutes to make their case. De Gaulle listened to each presentation and explained the attraction that some of the great ideas that he could grasp intellectually, of exploring space or the ocean depths, might be expected to have for a politician in his position. However, he said, despite all he had heard, deep within “I ask myself if this mysterious molecular biology, about which I understand nothing and will understand nothing, ... might be the basis of a new medicine about which today we have no idea, but which could be the medicine of the 21st century.” Molecular biology was selected as the top priority by the advisory group.

Raymond Latarjet was an outstanding clinician and researcher, but his interests extended far and wide. He was a well-respected alpinist, took part in Arctic exploration, and was a champion skier as a student. He was extremely knowledgeable about literature and music, and his wife was a professor of music at the Paris Conservatory. He was also a writer, winning recognition for his work in this capacity.

Latarjet was the chair of the IARC Scientific Council in 1972, and in the same year he was elected as a member of the French Academy of Sciences in the Section of Cellular and Molecular Biology. Given his Lyon affiliations, the Latarjet building, designed by the architect Christian Drevet, is a fitting reminder of his strong support to IARC over much of its early history.

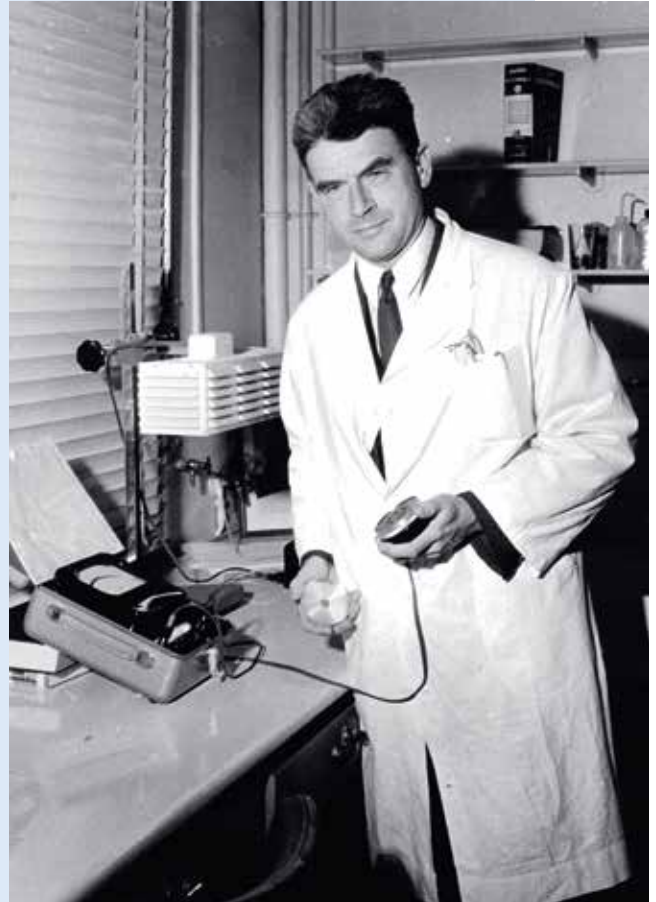

Raymond Latarjet in his laboratory at the Radium Institute in Paris.



The front of the Latarjet building.

The office in Kenya was synonymous with Allen Linsell, who coordinated IARC's early work on liver cancer (see the chapter "Carcinogens in the human environment"). The office in Iran was based on the interest in the high rates of oesophageal cancer in the Caspian littoral region (see the chapter "Nutrition, metabolism, and cancer"). Each centre was also linked to the development of cancer registries to describe the local cancer patterns.

These outposts of IARC, which were difficult to sustain, closed after a decision of the Governing Council in May 1980. However, an IARC office in The Gambia has been hosted by the United Kingdom Medical Research Council since the mid-1980s, linked to the Gambia Hepatitis Intervention Study (see the chapter "Viruses and vaccines"). The office there was refurbished in recent years and has permitted many ancillary studies to be developed alongside the main project, which also resulted in one of the few population-based cancer registries in sub-Saharan Africa. The idea of regional centres has also been revisited with the recent establishment of IARC Regional Hubs for cancer registration within the Global Initiative for Cancer Registry Development (GICR) (see the chapter "Cancer registries: a worldwide endeavour").

Ramou Njie, head of the Gambia Hepatitis Intervention Study (GHIS) project, Tumani Corrah, director of the Medical Research Council (MRC) The Gambia, and IARC Director Christopher Wild at the opening of the refurbished GHIS offices on the MRC campus in Fajara, The Gambia, in 2012.





On arrival, the first thing I noticed was an enthusiasm and pioneering spirit. These people with a profile of “explorers” went into the field and had travelled the world, to Africa, Asia, and South America. At IARC there was this pioneering side but also a multicultural side, with Russians, Italians, Japanese, and so on, each having a different background. – Gilbert Lenoir, former IARC scientist

MAKING A DIFFERENCE

It is remarkable that within a decade of its creation, IARC was already well known internationally for its research. It had established studies on Burkitt lymphoma, oesophageal cancer, and liver cancer, among others, and had 10 Participating States and a budget in 1976 of US\$ 4.2 million. Senior scientists had been attracted to this new venture, with 150 people working together in Lyon from many countries across the world. IARC also had international visibility through

its Regional Centres. It had established laboratories in Lyon to study mechanisms of carcinogenesis and already had in place its renowned Monographs Programme to evaluate the evidence on agents thought to cause human cancer. In the first 10 years, the IARC Fellowship Programme had awarded more than 150 Research Training Fellowships to junior scientists and 200 Travel Fellowships to senior scientists.

This level of progress was no doubt due to the drive of those who came to Lyon to turn a vision into practical reality. But it was also due to the vision itself – a lasting belief that by joining together across national boundaries and focusing on improving the human condition, scientists can achieve much that is good.

THE IARC DIASPORA

The vision for IARC was always one of collaboration, acting as a catalyst to international research efforts. One approach was to have IARC Regional Centres in areas where the patterns of cancer were of particular interest and where data could be collected on the occurrence of possible risk factors. The purpose was to develop long-term programmes, with the location requiring a strong interest of the local research community, both scientifically and through provision of infrastructure support. These Regional Centres were also seen as venues where IARC postdoctoral fellows could conduct some of their research. IARC provided modest resources to support each office, for example on the order of US\$ 5000 annually, and the leadership was local.

One of the first Regional Centres was operational as early as 1967, in Nairobi, Kenya. The choice was partly based on the observations of high liver cancer rates in sub-Saharan Africa, coming soon after the discovery



One of IARC's first studies, organized from its Regional Centre in Nairobi, was on aflatoxins and liver cancer in Kenya.

before later moving to Lyon; in 1975, the leadership passed to Ambrose Wasunna, with continued financial support from IARC to maintain the office and research activities.

in the early 1960s of aflatoxins as the most potent naturally occurring liver carcinogens yet identified. The IARC Regional Centre in Nairobi would conduct many of the food analyses for aflatoxins in Kenya and in other countries such as Côte d'Ivoire, South Africa, Swaziland, and countries outside of Africa. Further work focused on Epstein-Barr virus and Burkitt lymphoma in collaboration with Guy de Thé, who had joined the scientific team in Lyon. The centre also played a role in supporting several cancer registries across the region.

The Nairobi Regional Centre was synonymous with the person of Allen Linsell, who was already based in Nairobi and worked tirelessly to have the centre established not only at a strategic level but also down to the details; at one point, he promised John Higginson that the required refurbishment of the premises would certainly "not exceed £400". Linsell oversaw the construction of buildings dedicated to this new IARC outpost and opened by Higginson in 1969, even before the IARC headquarters building in Lyon.

Linsell was joined in his research efforts on aflatoxins and liver cancer by Frank Peers and Gregory O'Connor as the investigations took shape, including the epidemiological studies in Swaziland of liver cancer, aflatoxins, and hepatitis B virus infection. The Nairobi Regional Centre was also involved in early experiments on aflatoxins in baboons as an animal model. Linsell would lead the centre for several years



The new building of the IARC Regional Centre in Nairobi, opened in June 1969.



Ambrose Wasunna took over the leadership of the centre in 1975, after the departure to Lyon of Allen Linsell.

Singapore was another place chosen for an IARC Regional Centre – possibly the first, given that it was approved in late 1966 and formalized with the University of Singapore for an official opening in January 1967. As with Linsell in Nairobi, there was a key person involved in the developments, in this case Calum Muir. Muir was a pathologist working at the University of Singapore with plans to establish a cancer registry. Such a registry was lacking, but the enormous potential was recognized, based on the ethnic diversity, with the large populations of Malays, Chinese, and Indians having different cancer incidence rates. Interestingly, Muir would also later move to Lyon to join the growing complement of scientists helping shape the Agency.

The Singapore Regional Centre was established not least because of the commitment of Kanagaratnam Shanmugaratnam from the Department of Pathology, the person who would be the head of the centre for many years subsequently. The research studies focused on nasopharyngeal and liver cancers (including cholangiosarcoma) as well as on establishing the cancer registry, which began registration on 1 January 1968. The opportunities provided by the network of centres started to become evident, as Linsell linked up with the IARC Regional Centre in Singapore with respect to his liver cancer work in Nairobi.

The IARC Regional Centre in Kingston, Jamaica, was the third of those established by the end of 1967, in this case through an agreement with the University of the West Indies and under the responsibility of Gerrit Bras, a professor of pathology. The centre played an important role in supporting cancer registry development in Puerto Rico, Aruba, Bermuda, and Guyana, and also in Curaçao, where a high incidence of oesophageal cancer had been noted, with the disease at least as common among women as among men.

The IARC Regional Centre in Tehran was established somewhat later, in 1970, with the first formal agreement signed for the launch of the centre in 1971. Here, the major interest was also oesophageal cancer, with an extremely high incidence in the Caspian littoral region, where the rates in women even exceeded those in men. The work encompassed studies of opium use as well as other risk factors.

The formal agreement was with the Institute of Public Health Research at the University of Tehran, with the activities linked to the Babol Research Station. The agreement was maintained after the Islamic Revolution in the mid-1970s, but the work became more difficult to continue in practical terms. The Tehran Regional Centre was initially headed by E. Mahboubi through to the formal end of the agreement in 1980. In recent years, IARC has recommenced its work in the region, still without a firm conclusion as to the reasons for the startlingly high oesophageal cancer rates there (see the chapter “Nutrition, metabolism, and cancer”).

The IARC governing bodies reviewed the Regional Centre model in 1980 and decided that the centres should be closed. Standard letters were sent out by Higginson to this effect, thanking the heads of the centres for their work and collaboration over the years. From then on, collaborations would be focused around projects, as opposed to programmes, supported by Collaborative Research Agreements. The collaboration with Singapore, for example, continued on that basis.





1965 TO 2015:
IARC, A UNIQUE
INSTITUTION FOR A
CHANGING WORLD

1965 TO 2015: IARC, A UNIQUE INSTITUTION FOR A CHANGING WORLD

Il faut faire le pari que les avancées du bien se cumulent mais que les interruptions du mal ne font pas système. – Paul Ricoeur

A CHANGING WORLD

The world into which IARC arrived in 1965 presented a set of circumstances that without doubt aided its development: a receptive social and political setting, a freshly optimistic view of the potential of medicine to effectively control disease, and the emerging idea that cancer, rather than being considered an almost inevitable companion of ageing, could also be controlled. A journey into the world of the 1960s highlights each of these three circumstances.

The world in the 1960s

In the 20th century, Europe had twice been the origin and the major battleground of wars, called “world wars” for the first time in history because they rapidly spread to involve countries and populations from other continents. Contacts and exchanges – peaceful or violent – between populations had been occurring on a global scale since the beginning of the 16th century, acquiring increasing intensity with the expansion of European colonies on other continents. To these centuries-long exchanges, the two world wars added a tragic unifying experience, which gave rise to a radically new situation at the end of the Second World War, in 1945. First, a perception emerged anew of how the lives of all people in the world had become interwoven. Second, the communality of experiences prompted a movement towards communality of human rights, leading to the end of the colonial era; the colonies, still numerous in the 1940s, progressively became new autonomous countries. Third, major reconstruction efforts began that involved sustained economic growth. In developed countries, the gross domestic product per capita increased by close to 5% per year.

This long aftermath of the Second World War lasted about three decades, until the mid-1970s, and is on record as a golden age of increasing opportunities and well-being for all people, whatever their initial socioeconomic level. Economic growth alone would not have produced this result if it had not been accompanied – and, in several aspects, guided – by a vision and a widespread spirit of solidarity that had been awakened by the harsh experiences and lessons of the war. This vision was a driving force within countries, and internationally it repeatedly succeeded in overcoming deep ideological and political differences. The United Nations was established immediately after the war, in 1945, and its specialized agency for health, the World Health Organization (WHO), followed in 1948.

Europe embarked on an innovative and close cooperation, with the primary aim of preventing the repetition of armed conflict. Beginning in 1951 with a treaty between six countries, this involved the transfer of powers to the supranational level, and through a step-by-step process led to today's European Union with 28 member states. This setting of economic growth and solidarity within a framework of state regulations not only favoured the expansion of scientific research but also stimulated its international development. In 1954, the European Organization for Nuclear Research (known as CERN) was established in Geneva. Today, it is the world's leading facility for experiments and research on subatomic particles. CERN's 12 founding states have been joined by nine more member states, plus several associate members as well as observer states including the USA and Japan. In 1964, the European Molecular Biology Organization (EMBO) was established as an organization of life scientists. Since 1969, EMBO's programme and activities have received support from the governments of European member states (at present, 27) via the European Molecular Biology Conference (EMBC). Related to these initiatives, the independent European Molecular Biology Laboratory (EMBL) was founded in 1974; it is today supported by 21 member states and operates at five sites, including the central laboratory in Heidelberg.

The World Health Organization (WHO) was established on 7 April 1948. Its headquarters were hosted in the Palace of Nations in Geneva until 1966, when the WHO building, designed by the Swiss architect Jean Tschumi, was inaugurated. In 2014, an international design competition was launched to develop a new building and extend the existing one.

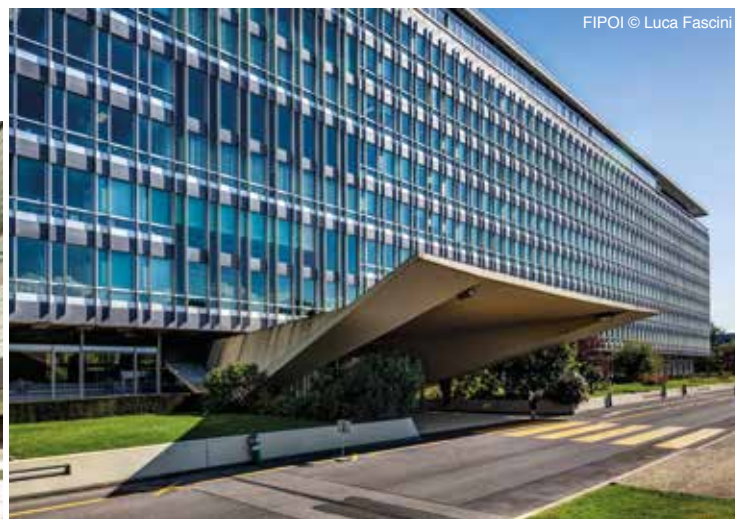

Health and medicine in the 1960s

Health conditions improved remarkably between the beginning of the 20th century and the 1960s. For instance, in 1910 average life expectancy at birth was still low, even in the most economically developed countries: only 47.3 years in the USA and 47.5 years in France. By 1965, these figures had become 70.3 and 71.0 years, respectively. This increase of more than 20 years is all the more remarkable because it occurred during a period that was marked by the massive loss of young lives during the two world wars. The improvement in health was due not only to better nutrition, hygienic measures, and work conditions but also to the fact that medicine “took off” and for the first time started to be regularly effective on a substantial scale.

Decline in rates of respiratory tuberculosis (measured as deaths per 1 million people per year) in England and Wales, with the same data plotted in two different ways. Key dates indicated are the discovery of the tuberculosis (TB) bacterium and the introduction of antituberculosis drugs (chemotherapy) and the bacille Calmette–Guérin (BCG) vaccine.

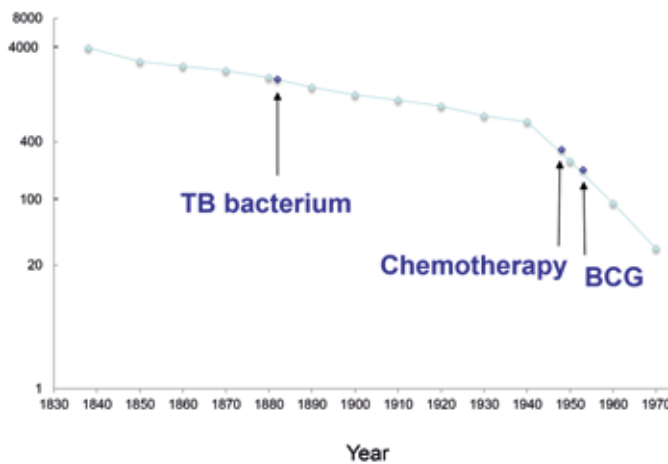
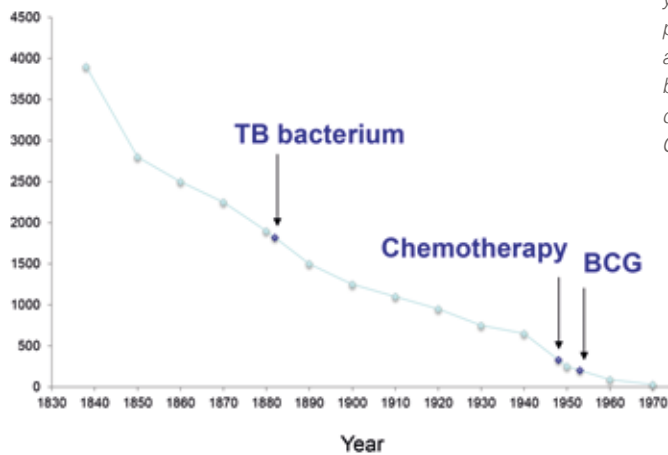

Top graph: ©The Nuffield Trust. Reproduced with permission.

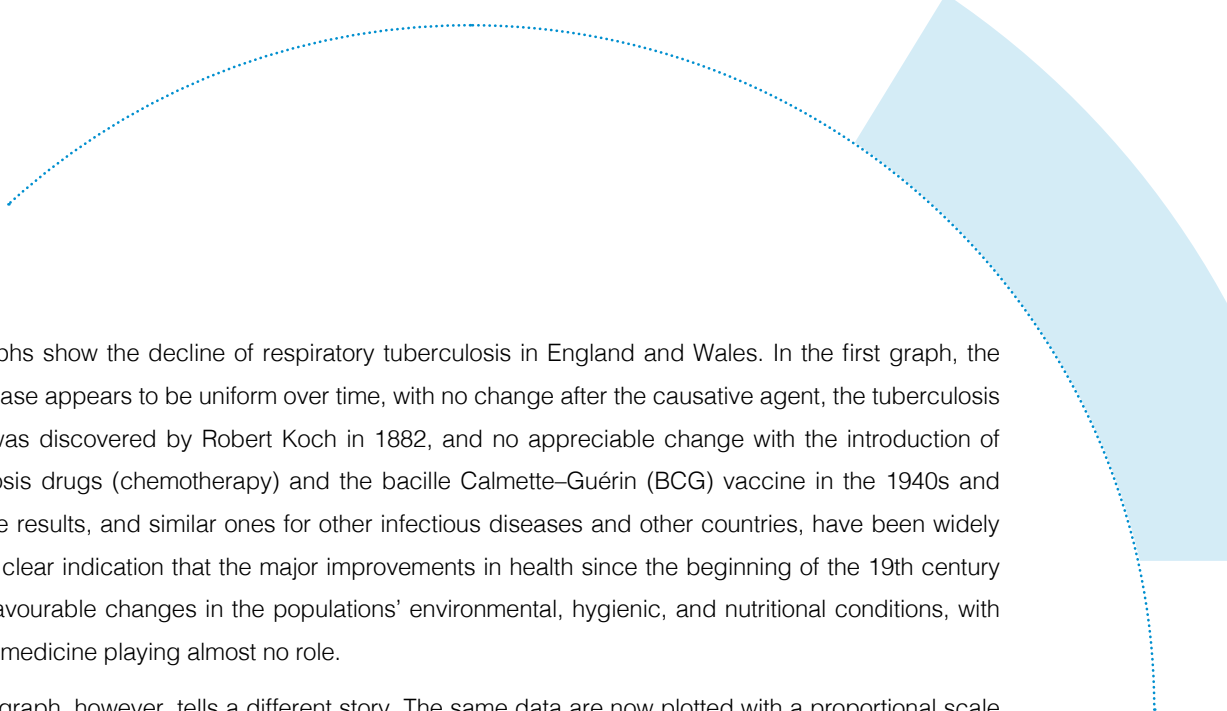

The two graphs show the decline of respiratory tuberculosis in England and Wales. In the first graph, the rate of decrease appears to be uniform over time, with no change after the causative agent, the tuberculosis bacterium, was discovered by Robert Koch in 1882, and no appreciable change with the introduction of antituberculosis drugs (chemotherapy) and the bacille Calmette–Guérin (BCG) vaccine in the 1940s and 1950s. These results, and similar ones for other infectious diseases and other countries, have been widely quoted as a clear indication that the major improvements in health since the beginning of the 19th century are due to favourable changes in the populations' environmental, hygienic, and nutritional conditions, with advances in medicine playing almost no role.

The second graph, however, tells a different story. The same data are now plotted with a proportional scale on the vertical axis, rather than an arithmetic scale as in the first graph. This representation provides a better insight into changes because in nature, quantities most often change by an amount that is proportional to the quantity present at each moment, rather than by a constant amount. It can be seen that although the discovery of the tuberculosis bacterium did not affect the decline in mortality, the introduction of chemotherapy produced a sharp change in the slope of the decline. Mortality decreased much more rapidly after 1945. This clearly shows that if before the Second World War improvements in health were probably due to better environmental, hygienic, and nutritional conditions, in more recent times advances in medicine have made major contributions.

Senior physicians who were practising in the 1960s and had graduated from medical school in about 1930 had lived through a radical change in medicine. In 1930, only a handful of effective and reasonably safe medications were available: essentially, several vaccines, aspirin, and digitalis. Surgeons could do much more, but with the exception of a few operations, such as those to treat fractures, the short- and long-term outcomes for patients remained variable. By the 1960s, a panoply of new classes of medications had been discovered and made available for clinical use. For example, sulfonamides, the first class of antibacterial drugs, were introduced in the mid-1930s; antibiotics followed, during the Second World War. Cortisone and related compounds were used from 1948 onwards, and safe and potent diuretics and psychotropic drugs since the early 1950s. Alongside therapeutic agents, diagnostic procedures had also undergone a marked expansion, notably based on the development of clinical biochemistry, histochemistry for the microscopic examination of tissue specimens, and physiological function tests suitable for clinical use. These advances fundamentally changed the general perception of what medicine could actually do. In particular, academic teachers shifted their perspective completely: from one in which making correct diagnoses represented the pinnacle of professional skill and achievement (with the disease being left largely to take its natural course) to one in which the cure or control of the disease became the measure of professional success.

Even more impressive and fundamental is the progress that occurred in the understanding of basic biological functions and structures. Artificially produced isotopes became available in the 1930s to label biological molecules and trace their behaviour within the body. The title of a 1942 book by Rudolf Schoenheimer,



In the entrance hall of IARC's tower building, DNA welcomes people. This sculptural representation of DNA by French artist Pierre Mathieu was a gift of the Mérieux Foundation and – as an inscription reads – “expresses the fundamental poetry embedded in the natural DNA structure”.

The Dynamic State of Body Constituents, concisely expresses the concept, arising from investigations with tagged molecules, that living organisms are open systems, stable but in a constant state of renewal and exchanging components with the surrounding environment. Tracer molecules revolutionized the study of metabolism and other physiological functions, making it possible to examine both normal and pathological processes in undisturbed in vivo settings.

At the beginning of the 1950s, substantial knowledge had accrued on the chemical composition of nucleic acids, particularly DNA. Thanks to the fundamental discoveries of Oswald Avery, Colin MacLeod, and Maclyn

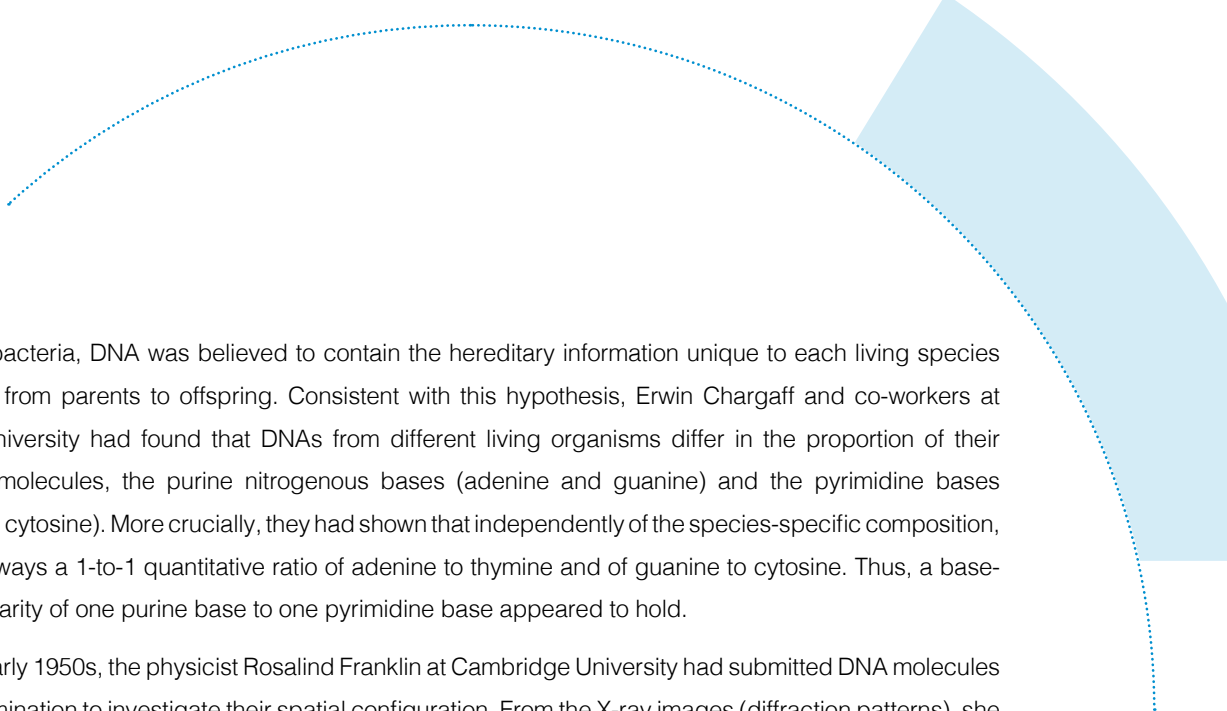

McCarty in bacteria, DNA was believed to contain the hereditary information unique to each living species and passed from parents to offspring. Consistent with this hypothesis, Erwin Chargaff and co-workers at Columbia University had found that DNAs from different living organisms differ in the proportion of their component molecules, the purine nitrogenous bases (adenine and guanine) and the pyrimidine bases (thymine and cytosine). More crucially, they had shown that independently of the species-specific composition, there was always a 1-to-1 quantitative ratio of adenine to thymine and of guanine to cytosine. Thus, a base-pairing regularity of one purine base to one pyrimidine base appeared to hold.

Also in the early 1950s, the physicist Rosalind Franklin at Cambridge University had submitted DNA molecules to X-ray examination to investigate their spatial configuration. From the X-ray images (diffraction patterns), she inferred that “the results suggest a helical structure (which must be very closely packed) containing probably 2, 3, or 4 coaxial nucleic acid chains per helical unit.” By the spring of 1953, James D. Watson and Francis Crick understood that to satisfy the base-pairing regularity, a long helical structure should be composed not of a single strand but of two paired strands. They published an epoch-making two-page paper in *Nature* in which they proposed a DNA structure model rigorously coherent in its chemical and physical features: the soon-to-be-famous double helix, which has stood the test of time. Biology was transformed, particularly genetics. It was now possible to investigate how the hereditary information passed from parents to offspring was coded in the form of distinct units (the genes) in the well-identified DNA structure, the key component of chromosomes in humans. Deciphering the code and how it is translated into instructions that ultimately control human physiology expanded into a vast area of research during the 1960s.

In parallel, knowledge of the DNA structure opened new avenues to the understanding of how the environment may affect genes, producing not only transient, repairable damage but – more importantly – stable and heritable gene mutations. Experiments by Hermann Muller investigating heritable characteristics, such as eye colour, in fruit flies had already shown in the 1920s that X-rays can produce gene mutations. Subsequently, the mutagenic effects of several chemicals, such as mustard gas, had been demonstrated in the 1940s and 1950s, particularly through the work of Charlotte Auerbach, John Michael Robson, and Eric Boyland. Against this background and with the DNA structure now elucidated, by the late 1950s and early 1960s Philip Lawley was able to characterize the binding between specific DNA bases and the molecules of known carcinogens, such as polycyclic aromatic hydrocarbons, the ubiquitous products of incomplete combustion that are found, for instance, in tobacco smoke. Light started to be shed on the paths linking agents present in the environment to cancer: the binding of carcinogens to DNA bases produces mutated genes capable of inducing or permitting the unlimited cell proliferation that is characteristic of cancer.

Combined with the practical results of medicine, all these burgeoning advances in biology fuelled widespread optimism about what biomedical sciences could achieve.

CANCER IS HUNDREDS OF DIFFERENT DISEASES

The term “cancer” describes a diverse group of several hundred diseases, arising from different types of cells and in different organs of the body, in humans or animals. Each disease presents with its own clinical manifestations and evolves with its own course. However, all of them share a common and fundamental trait: the uncontrolled proliferation of some cancer-originating cells (“cancer stem cells”). If left untreated, this inordinate cell multiplication, combined with invasion of neighbouring or distant organs, leads to death after a highly variable period of time; some cancers grow rapidly, others slowly.

The endless proliferation of cells implies that some heritable command to replicate is transmitted from each generation to the next. In fact, it has long been recognized that heritable genetic alterations lie at the core of cancer development, and more recent studies have shown that a typical cancer contains several abnormally mutated “driver” genes that confer a selective growth advantage to the tumour cells. This may result from mechanisms controlled by the driver genes, such as inhibition of senescence, programmed cell death, or immune destruction that would normally prevent the cells from reproducing. It may also derive from genomic instability, favouring the emergence of cells capable of successfully surviving and replicating in different compartments (microenvironments) of the body. This is what makes a cancer a killer: the great majority of patients dying of cancer have multiple colonies (metastases) of the cancer in organs distant from the original site, for instance in the brain, lungs, and bones from a prostate cancer. Unless highly localized, these colonies are usually difficult or impossible to access for surgical removal or radiation therapy, and their variable genetic make-up increases the probability that some of them will prove resistant to anticancer drugs. As a result, the development process is very similar for all cancers, but the biological characteristics, clinical manifestations, course, and opportunities for treatment have distinct profiles for individual cancers.

From a population viewpoint, cancers have always been present in humans (and other animals); the first mention dates back to about 3000 BC, in an Egyptian papyrus that reports breast cancers. Two factors have greatly increased the number of cancer cases recorded in contemporary populations: our diagnostic ability to recognize them as separate from other diseases, and the progressive ageing of populations. Cancers of epithelial tissues, such as those arising in the lung, colon, and breast, represent more than four fifths of all cancers and have a frequency that increases sharply with age. The ubiquitous presence of cancer had already made it a major public health issue, nationally and internationally, in the early 1960s, when the proposal for an international centre devoted to catalysing cancer research was formulated.

A new outlook on cancer

Cancer research was soon included in these justified hopes (see “Cancer is hundreds of different diseases”). Although there had been some progress in cancer research and in therapeutic interventions – essentially, surgery and radiotherapy – during the first half of the 20th century, the stark reality of cancer in humans was captured by the opening sentence of a 1956 paper: “The most obvious manifestation of cancer is that it kills.” However, some attempts had already been made to treat cancer with single drugs synthesized in the 1940s and capable of countering the proliferation of cancer cells in cases of lymphoma and childhood leukaemia.

Transient remissions of disease were obtained, motivating the development of rigorous studies of efficacy in humans. Randomized clinical trials to test various multidrug regimens, including several new molecules, were initiated by such institutions as the United States National Cancer Institute in 1954–1955 and the United Kingdom Medical Research Council in 1957. The idea that cancers are basically not medically treatable faded away, as did, about a decade later, the concept that cancers are not preventable. Richard Doll's 1967 book *Prevention of Cancer: Pointers from Epidemiology* most effectively expresses this changed view, buttressed by sound scientific arguments (see “Preventing cancer”).

John Higginson, the first IARC Director (from 1966 to 1981), is seen here at a New Year's reception with his wife Nan and Anton Geser (left). Geser is the epidemiologist who, with Guy de Thé, conducted the IARC studies on Burkitt lymphoma in Uganda and the United Republic of Tanzania (see the chapter “Viruses and vaccines”).

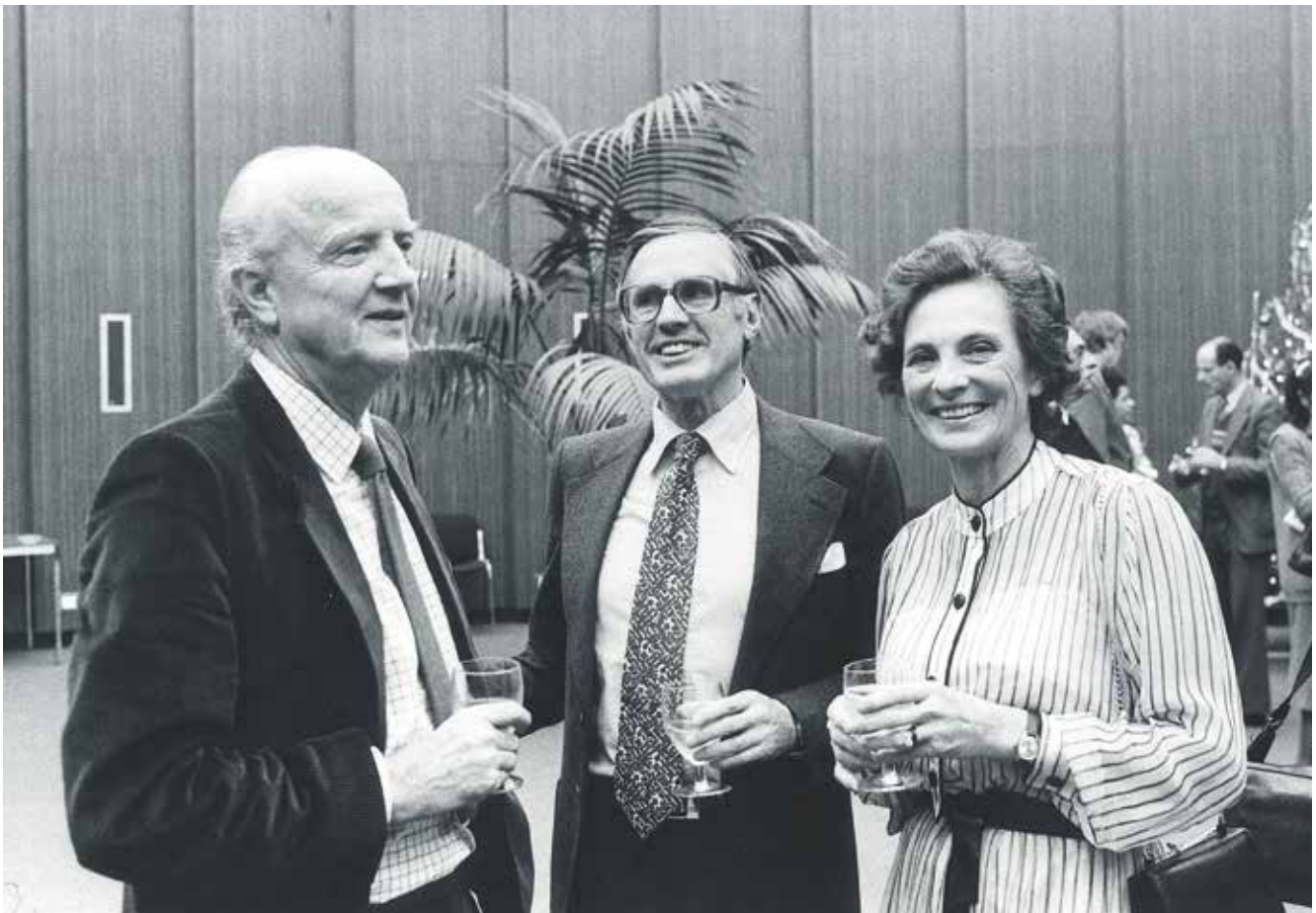

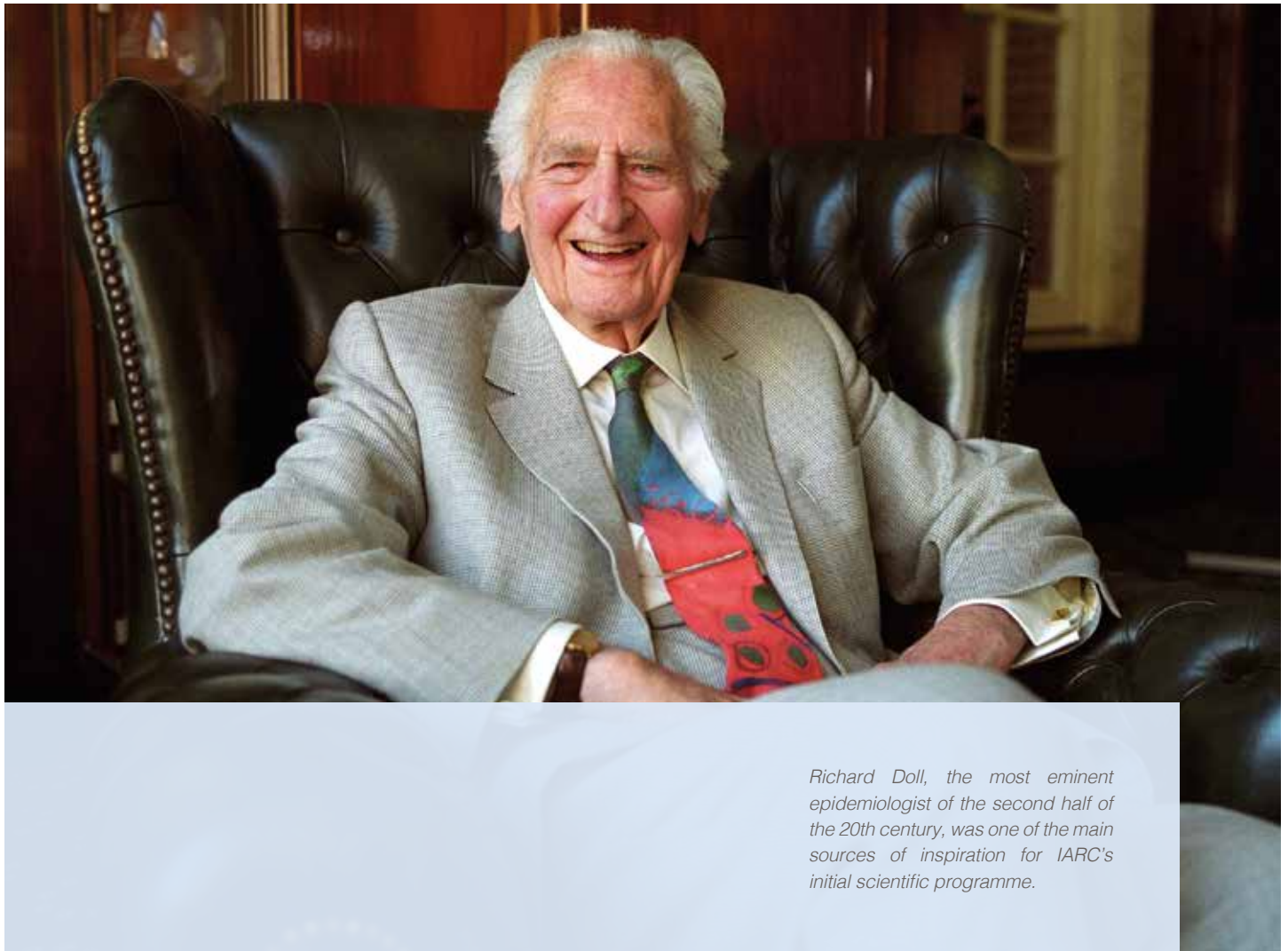

Richard Doll, the most eminent epidemiologist of the second half of the 20th century, was one of the main sources of inspiration for IARC's initial scientific programme.

PREVENTING CANCER

The following is an extract from the introduction of Richard Doll's *Prevention of Cancer: Pointers from Epidemiology*.

"When, some fifteen years ago [in about 1950], a professor of surgery told me that it was not only a waste of time but also faintly immoral to try to prevent cancer, he had in mind the idea that the development of cancer was part of the normal process of ageing. Attempts to interfere with it were, at best, doomed to failure. At worst they represented the sort of *lèse-majesté* which Prometheus was guilty of, and were liable to lead to some comparable retribution. This view was not, I hope, widely held; but it represented, in extreme form, a fatalistic attitude that was. So little was known about the nature of malignant cells and of the processes that normally regulate tissue growth that the prevention of cancer, regarded as theoretically possible, was not thought to be a practicable current objective. Medical education and public hopes were, therefore, concentrated on methods of improving treatment and of diagnosing the disease at an early stage, when treatment might be more effective.

"Since then the situation has altered radically. New classes of chemical carcinogens have been discovered, some of which occur naturally in the human environment and are capable of causing experimental cancer in organs that were previously difficult to affect. It is now known, for example, that nitrosamines, given by mouth, will readily produce cancer of the oesophagus, stomach, or large bowel. Fungi, like *Aspergillus flavus*, have been

shown to produce metabolites in foodstuffs stored under hot and humid conditions, minute doses of which will produce cancer of the liver and stomach. ... And overshadowing all this is the discovery that viruses can produce cancer in so many species of animals that it is difficult not to believe that they can also produce some types of cancer in man.

"Pari passu with these developments, epidemiological studies have shown that cancer incidence in man is far more dependent on the conditions of his life than had previously been supposed. The few classical examples of cancers that occurred with heavy exposure to a specific occupational hazard, or were associated with such bizarre habits as smoking a cigar with the burning end inside the mouth, have been steadily added to; and in some instances it has been possible to show that the incidence of cancer falls when the method of work or the associated habit is changed. Variation in incidence is, moreover, now known to be the rule rather than the exception. No cancer that occurs with even moderate frequency, occurs everywhere and always to the same extent. A range of ten or twentyfold is common and for some types of cancer it is far wider. Sometimes it has even been possible to recognize an epidemic, similar in scale to an epidemic of infectious disease, but modified by the fact that the induction period may be of the order of thirty years.

"A change in attitude has, therefore, occurred and the prevention of cancer is now coming to be regarded as a practicable alternative to its cure. We are, however, still almost totally ignorant of the mechanism by which cancer is produced at the cellular level and, until we know this, our methods of prevention are liable to be cumbersome and inefficient. Ethical considerations and the time scale of the disease make it impossible to obtain experimental evidence in man, and we have to decide what action to take from observation of Nature's experiments and by analogy from experiments in animals."

Reprinted with permission from the introduction of Richard Doll's *Prevention of Cancer: Pointers from Epidemiology*.
© 1967 by The Nuffield Provincial Hospitals Trust, London.

One of the most striking features that contributed to this new perspective was the observed variation in the occurrence of specific types of cancers in different geographical areas, as reflected in cancer mortality statistics or directly documented by recorded clinical diagnoses of new cases. Such variations were often very large, suggesting that they could be due to the variability of the conditions prevailing in the various areas. For instance, lung cancer was reported to be 40 times as common in areas of the United Kingdom as in Uganda, oesophageal cancer 100 times as frequent in some districts of the Islamic Republic of Iran as in the Netherlands, and liver cancer 1000 times as common in Mozambique as in Sweden. A hypothetical country in which the lowest observed rates of each cancer occurred would have had about 90% fewer cancers than a hypothetical country with the highest observed rates of each cancer. Therefore, the reasonable hypothesis was put forward that the great majority of cancers, perhaps even 90% of all cancers, could be due to external conditions or "environment", which John Higginson, the first IARC Director, defined as follows: "Environment is what surrounds people and impinges on them. The air you breathe, the culture you live in, the agricultural habits of your community, the social cultural habits, the social pressures, the physical chemicals with which you come in contact, the diet, and so on."

The cancer-causing factors that had been established by 1967	
Type	Factor
In the general environment	Ionizing radiation
	Ultraviolet radiation
In the local and occupational environment	Asbestos
	Nickel refining
	Chromate manufacture
	Inorganic arsenic compounds
	Mustard gas manufacture
	Fumes from gasworks
	Isopropylene
	Alpha- and beta- naphthylamine
	Benzidine
	Xenylamine
	Benzene
Personal behaviours	Tar and other coal combustion products
	Ointments containing coal tar
	Chewing of tobacco, betel, and lime
Pharmaceutical drugs	Tobacco smoking
	Alcohol consumption
	Chlornaphazine
Infections	<i>Clonorchis sinensis</i> (Chinese liver fluke)
	Virus inducing Burkitt lymphoma
Predisposing conditions	Tropical ulcers
	Ulcerative colitis

The plausibility of this hypothesis was supported by what was already known about several cancer-causing factors, all belonging to the environment in its broadest sense. The table summarizes the evidence as portrayed in Doll's book. Johannes Clemmesen, who founded the world's first nationwide cancer registry, in Denmark in 1942, reviewed and presented in detail all relevant studies available up to 1965 in his masterly opus *Statistical Studies in the Aetiology of Malignant Neoplasms*. Epidemiological research, by itself and in combination with experimental investigation in animals, was identifying causal factors of cancers within a variety of environments, while observations of variations in cancer occurrence between populations were providing valuable indications of where to look for such factors. Investigating environments and populations at the international level appeared to be the best response to the need for developing these research avenues. Onto this favourable ground fell the French initiative for a new cancer agency (see the chapter "The birth of

IARC”). This proposal was well in tune with the contemporary climate of confidence in biomedical research and clinical medicine, and with the willingness of individuals and governments to promote international collaboration in science via the establishment of new institutions, as had already occurred for CERN and EMBO.

Rounding off the corners

Newborns occupy space, and IARC was no exception. Established in 1965 as a consequence of the proposal by French public figures, IARC first had to identify its specific areas of research, to avoid overlaps (and friction) with other organizations, to fill unmet needs, and to create new opportunities for synergistic collaborations. In broad terms, IARC’s areas of research would be cancer etiology, including the study of mechanisms, and cancer prevention. After initially being hosted by WHO in Geneva, IARC moved to temporary premises in its permanent home, Lyon, and finally to the 14-floor tower ordered expressly for IARC by the French authorities. In the design of the new building, the corridors of the square tower joined at right angles, which posed an obstacle to the passage of laboratory carts. This obstacle was removed – as remembered by Higginson’s wife – by rounding off the corners of the corridors (see “John Higginson, first IARC Director”).

There were corners of a different kind to be rounded off as well, concerning IARC’s research strategy. Two such decisions were crucial for IARC’s future. During the discussions leading to the establishment of IARC, diverging views had been expressed by representatives of the countries involved about the suitability of having laboratories included within IARC at all. One view was that IARC’s activity should be centred on and limited to epidemiology. It is to Higginson’s credit that by “rounding off the corners” he eventually carried the case for laboratories to be an integral part of IARC’s activity. This had two advantages. First, it favoured

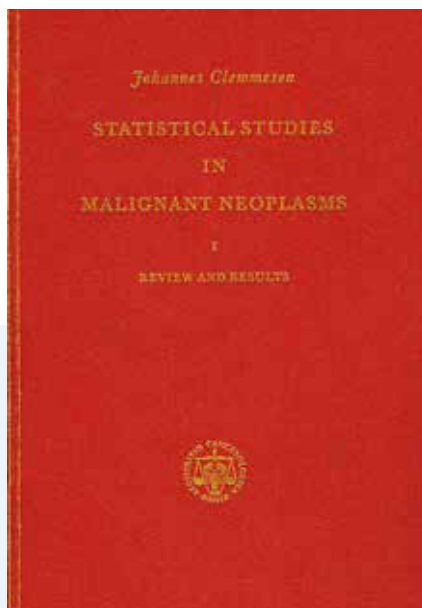

JOHN HIGGINSON, FIRST IARC DIRECTOR

Nan Higginson paints a vivid portrait of her husband John at the time that he was appointed as the first IARC Director: “John viewed the invitation to be the first director of the newly established idea of an international centre for cancer research as a unique opportunity to expand the field of environmental cancer research into an integrated global endeavour.

“Although happily established in his job in Kansas, USA, it became evident to him that his path seemed to lead to such an international position, starting with his medical degree from Trinity College in Dublin, Ireland, then in the pathology department at the Western Infirmary in Glasgow, Scotland, followed by eight years at the South African Institute for Medical Research, in Johannesburg. In South Africa, he was also a pathologist at the 200-bed Baragwanath Hospital. His experiences at this hospital and his visits to the surrounding mission hospitals led to him becoming particularly interested in cancer research.

“Under his leadership, IARC established satellites in over 70 countries around the world. This was a result not only of John’s dedication to the advancement of cancer research as an international pursuit, but also reflected his profound respect for the scientific endeavours of scientists from all over the world, as well as a deep enjoyment and curiosity regarding different cultures.

“When John started at IARC, he had to wear many different hats! He took a keen interest in all aspects of the running of the centre, ranging from the layout of the laboratories to the construction of the new building. For example, the numerous architects handling the construction of the building hit a stumbling block when it was pointed out to them that their design was not suitable for the laboratory floors, as the trolleys could not get around the corners of the passages. When they were unable to find a solution, it was John who suggested that they should round off the corners of the corridors, which is what they did!”



The IARC tower building in the eighth district of Lyon, with the waving flags of the World Health Organization and of the 24 IARC Participating States.

the incorporation of laboratory tests into epidemiological studies, a feature of growing importance with the development of biomarkers of exposure, susceptibility, and early lesions that are measurable in humans. Second, placing epidemiologists and scientists carrying out in vivo and in vitro experimental research under the same roof enabled even a moderately sized institution like IARC to stay at the frontiers of cancer research.

Corners also needed to be rounded off with respect to the development of descriptive epidemiology, a key *raison d'être* of IARC. Registration of all cancer cases occurring in a defined population had initially taken the form of studies covering a limited period of time. In the 1940s and 1950s, this had been upgraded into permanent systems of case recording or “cancer registries”, such as those for the state of Connecticut in the USA or for the whole country in Denmark. Registries became fundamental tools for measuring cancer incidence in defined populations. (Incidence is the expression of the ensemble of carcinogenic factors active in a population, whereas mortality provides a less clear picture since it is also determined by treatment.) To enable the comparison of statistics across different populations, methods of registration and of data analysis needed to be uniform. The International Union Against Cancer (UICC, now called the Union for International Cancer Control), an association of national scientific cancer organizations, had played a key role in promoting cancer registration and had commissioned a team of scientists to produce a first report on data from several registries, which was published in 1966 with the title *Cancer Incidence in Five Continents*.

“

Richard Doll was one of the first editors of Cancer Incidence in Five Continents, and this publication demonstrated that the variation in cancer rates between one country and another was real, which meant that where cancer was common, it didn't have to be.

– Richard Peto, long-term IARC collaborator

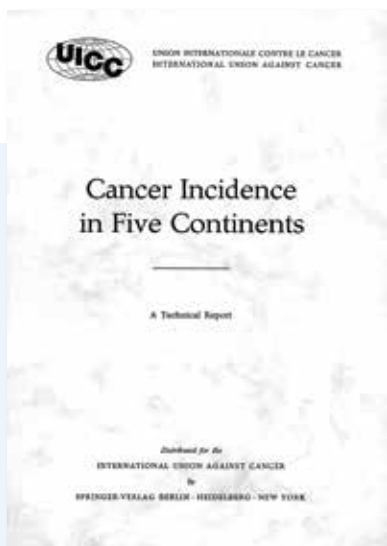

UICC promoted the collection of cancer incidence data worldwide. The first comprehensive compilation of the most comparable information available at the time was published in 1966 as a volume edited by Richard Doll, Peter Payne, and John Waterhouse (shown here).

The development of the appropriate technical capacity at IARC translated into a collaborative endeavour of UICC and IARC for the second volume of the report, published in 1970. With the rapid increase in the number of cancer registries around the world, the programme became, with the third volume (in 1976), a major ongoing activity of IARC in cooperation with the International Association of Cancer Registries, a nongovernmental organization established in 1966.

2015: IARC'S GOLDEN ANNIVERSARY

Today, IARC is active in a world that has changed even more in the 50 years since its establishment than in the previous half a century. Postdoctoral fellows in their twenties or thirties working at IARC today make continual use of email and smartphones with a wide variety of applications for daily life and work. They can participate in videoconferences when organizing a new project and certainly spend most of their working time in front of a computer screen. In the laboratory, a vast range of operations, from manipulating blood samples, cells, or tissue specimens to performing biological, physical, or chemical procedures, now use automatic and programmable equipment. None of these existed in 1965. Then, the analysis of data – a fundamental daily task for all research – was routinely done using mechanical calculating machines. Writing down the results, entering them into the next step in a calculation, and repeating the whole procedure at least twice to be sure that the results were correct – all this had to be done directly by a human operator. Calculating the dependence of a variable like body weight on several other variables, such as caloric intake, amount of physical exercise, and quantities of different foods, kept an operator busy for hours or days, depending on how many sets of variables were being explored. Today, such a calculation takes a matter of seconds or minutes with a computer performing 10 billion operations per second.

Between 1965 and 2015, biology has been transformed as deeply as computer sciences and information technology. It has come all the way from deciphering the basis of the genetic code embodied in DNA to the determination of the sequence of more than 3 billion base pairs in a typical human genome, completed in 2004. It is now possible to determine the genome of a single individual with all its sequence variants at a cost of about US\$ 1000 – and falling. Major advances in scientific knowledge may or may not lead to practical applications, but they invariably generate a large spectrum of new questions to be investigated. This is now under way in the ever-expanding “omics” fields like transcriptomics, proteomics, metabolomics, and epigenomics, which in their turn have been embraced by IARC scientists. These

“
The arrival of computing was a revolution. What was important was that over the years the revolution was a success: the performances in terms of data management improved considerably, particularly as a result of the computing team that was brought together at that time.

– Jacques Estève, former IARC scientist

approaches allow exploration of how physiological messages are dictated by DNA in its individual variants and interact with non-genetic messages arising from the environment – beginning with influences of the maternal environment on the embryo – to guide the development of the organism and regulate (and deregulate) its functions.

Medicine, too, has come a long way since 1965. In addition to improvements in all fields, several entirely new branches have been developed. Body imaging, then limited to X-ray techniques, now includes a variety of ultrasound methods, computed tomography (CT) scans, magnetic resonance imaging (MRI), and positron emission tomography (PET) scans, and more techniques are constantly being developed. Intensive care medicine, still in its infancy in the 1960s, has transformed the treatment of many acute conditions. Organ transplants, then confined to corneal transplants and very tentative early attempts for other organs, have become routine. Minimally invasive and robotic methods are changing the practice of surgery. Cancer medicine has prominently participated in and contributed to these transformations both in diagnosis and in treatment. A single feature aptly captures how advances in cancer medicine have translated into benefits for the population: survival rates of all cancer patients in defined areas, irrespective of care and treatment. The figures in the table are from the USA, but the time trend (although not necessarily the actual survival percentages) is similar in many developed countries; there has been a remarkable improvement for most sites, with dismal figures persisting for a few sites.

Progress in cancer treatment: percentage survival (relative to normal life expectancy) of patients at 5 years after initial diagnosis, for main cancer sites

Site	Period		
	1947–1951	1975–1977	2003–2009
Oesophagus	4	5	19
Stomach	7	15	29
Colon	36	51	65
Rectum	32	48	68
Pancreas	2	2	6
Larynx	47	66	63
Lung	5	12	18
Breast (women)	54	75	90
Cervix uteri (women)	62	69	69
Ovary (women)	28	36	44
Prostate (men)	28	68	100
Bladder	38	72	80

Thus, for half a century, a story has unfolded of remarkable scientific and technological advances, spreading to increasingly larger areas of the world. The radical changes, which have contributed to creating challenges in all aspects of life, have never before occurred in such a form or on such a scale.

Global challenges for the new century

Three of these global challenges form the broad background to the present and future activity of IARC: the ageing of populations, environmental change, and the evolving inequities between and within countries. These challenges are crucial both individually and in their interactions.

Global ageing of populations

Cancer is largely a disease of ageing, and as life expectancy continues to increase, notably in the developing countries, the global burden of cancer will rise (see the chapter “IARC: the second 50 years”). As shown in the table, average life expectancy at birth increased worldwide from 51.2 years in 1960–1965 to 67.9 years in 2005–2010, a gain of more than 4 months per year, and a striking 6 months per year in Asia. Combined with sharply decreasing fertility, from 4.9 births per woman in 1960–1965 to 2.5 in 2005–2010, this is revolutionizing the population structure of the human species. While the proportion of young people (below age 15) is diminishing worldwide, the proportion of older people (above age 65) is increasing rapidly; the fastest growing group is those older than 80. A United Nations estimate indicates that by 2050 – when the world’s population is likely to have exceeded 9 billion – for the first time in history the number of people older than 60 will exceed the number of people younger than 15; this has already happened in several economically developed countries. Population ageing has profound consequences and implications in all spheres of life. For each person above age 65, there were 12 people of working age (15–64 years) in 1950, and 9 in 2000, and in 2050 there will be only 4. This sharp increase in the elderly dependency burden placed

Average life expectancy at birth (in years)		
Region	Period	
	1960–1965	2005–2010
World	51.2	67.9
Africa	42.4	55.2
Asia	46.4	69.0
Europe	69.6	75.4
Latin America	56.8	73.4
North America	70.2	78.2
Oceania	64.1	76.6



on people of working age is further aggravated if only a fraction of people of working age are economically active. Health is obviously a prominent aspect of population ageing; 80% of older people have at least one chronic condition and 50% have two or more, and acute diseases and injuries take a disproportionate toll on older people. Population ageing already requires major changes in the organization and functioning of health and social services and poses a challenge to all strategies of cancer control.

Global environmental change

The health effects, acute and chronic, of local, home, and occupational environments have long been known and continue to be described and investigated. Lung cancers caused by air pollutants, like diesel exhaust or asbestos fibres, and skin cancers caused by solar ultraviolet radiation are just two examples among many. In recent years, a potential new threat – of a global nature – has emerged. As the extensive work of the Intergovernmental Panel on Climate Change has documented in its periodic Assessment Reports (the fifth of which was published in 2014), man-made emissions of greenhouse gases, principally carbon dioxide, continued to increase from 1970 to 2010, with larger increases after 2000. Two factors are driving this trend of increasing emissions that outpace the reductions due to improvements in energy efficiency: population growth and expanding economic activities. If unmitigated, the greenhouse effect may cause an increase in the global mean surface temperature of 3.7–4.8 °C by the end of this century, with major effects on sea levels and coastal configurations, land fertility and agricultural production, and animal species (survival, location, migration patterns, and species interactions). Ultimately, human health will be affected – both directly, by environmentally induced diseases, and indirectly, through disruption of agriculture or as a consequence of mass emigration from areas that become inhospitable. There is currently some evidence of increased heat-related mortality and decreased cold-related mortality in some regions as a result of global warming. Heat waves have shown a precipitating lethal effect on subjects vulnerable because of pre-existing serious conditions, including cancers, especially when these are combined with low socioeconomic levels. At present, the worldwide burden of ill health, including cancer, related to global warming is small and is not well quantified. However, to be effective, actions to prevent further warming and more extensive damage to human health cannot be postponed; they must be taken now.

Global inequities

Two distinct and often diverging forces, each with an impact on the health of populations, are at work at the beginning of this century. First, a heightened awareness of the crucial role of social determinants of health and disease is prompting a variety of actions and programmes that aim to improve these determinants. Second, and often discordantly, an increasingly dominant free-market approach in all domains of life, public and private, is tending to treat health as a commodity whose value is signalled by its market price.

HEALTH AND DISEASE ARE SOCIALLY DETERMINED

The Commission on Social Determinants of Health made the following concise statement in its final report.

“The poor health of the poor, the social gradient in health within countries, and the marked health inequities between countries are caused by the unequal distribution of power, income, goods, and services, globally and nationally, the consequent unfairness in the immediate, visible circumstances of people’s lives – their access to health care, schools, and education, their conditions of work and leisure, their homes, communities, towns, or cities – and their chances of leading a flourishing life. This unequal distribution of health-damaging experiences is not in any sense a ‘natural’ phenomenon but is the result of a toxic combination of poor social policies and programmes, unfair economic arrangements, and bad politics (that prize the interests of some over those of others – all too often of a rich and powerful minority over the interests of a disempowered majority). Together, the structural determinants and conditions of daily life constitute the social determinants of health and are responsible for a major part of health inequities between and within countries.”

Reprinted with permission from *Closing the Gap in a Generation: Health Equity Through Action on the Social Determinants of Health: Final Report of the Commission on Social Determinants of Health*. © World Health Organization 2008.

Current male life expectancy at birth (in years) in selected countries and in two selected locations within the United Kingdom (Scotland) and within the USA

Location	Life expectancy at birth
United Kingdom, Scotland, Glasgow (Calton district)	54
India	62
USA, Washington, DC (Black residents)	63
Philippines	64
Lithuania	65
Poland	71
Mexico	72
USA	75
Cuba	75
United Kingdom	77
Japan	79
Iceland	79
USA, Montgomery County (White residents)	80
United Kingdom, Scotland, Glasgow (Lenzie North)	82

The crucial role of social determinants of health has been delineated in a key report of the Commission on Social Determinants of Health (see “Health and disease are socially determined”).

The examples in the table tell a story of general importance: health, as measured by life expectancy at birth, is worse in poorer countries, and within richer countries it is worse among more deprived populations. Additional striking confirmation comes from episodes of worsening population health after a rapid deterioration of socioeconomic conditions. For example, during the 1990s, life expectancy (at age 20) declined sharply in the Russian Federation, most notably among less educated men, because of a rise in adult mortality ensuing from the dissolution of the Soviet Union in 1991, accompanied by drastic changes in the political, economic, and social systems. More recently, the economic “austerity” measures imposed in Greece due to the debt crisis are reflected in increased rates of suicides and mental disorders and in a reversal of the long-term trend of decreasing infant mortality.

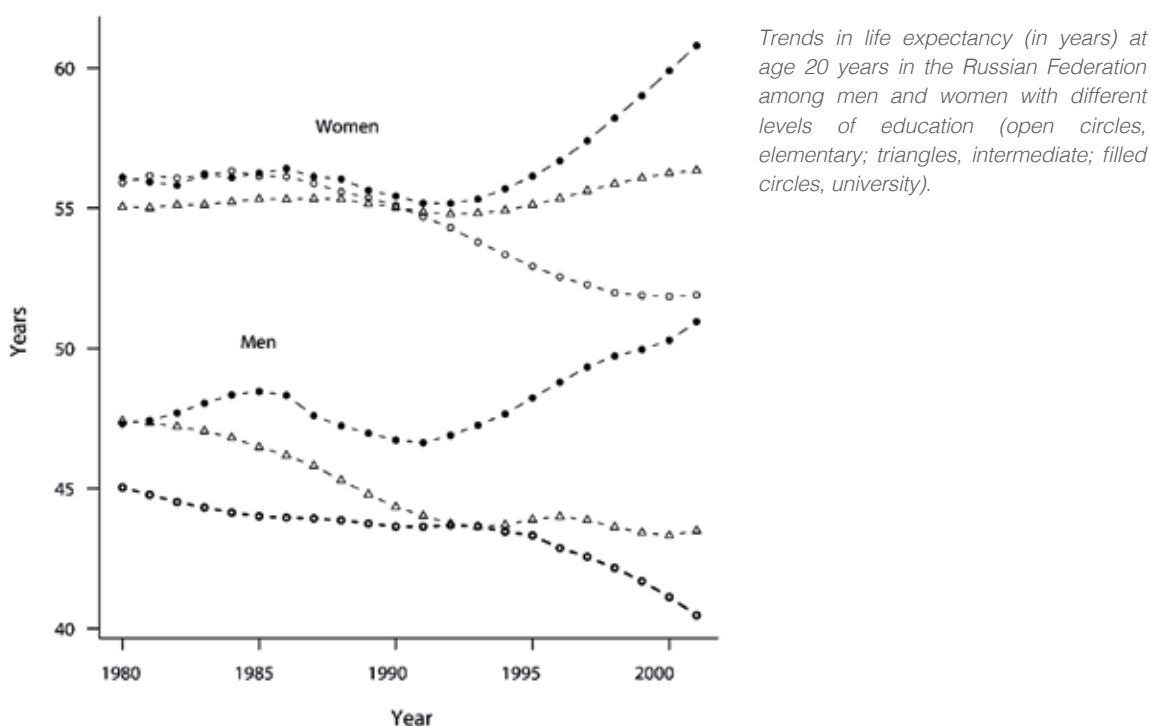

Based on its diagnosis of the overwhelming impact of social determinants on health, the Commission formulated three overarching recommendations to “close the inequity gap” within one generation: improve daily living conditions; tackle the inequitable distribution of power, money, and resources; and measure and understand the problem and assess the impact of action. The recent evolution of the global economy and the distribution of people’s incomes, as a result of globalization policies mostly guided by pro-free-market priorities, may hinder rather than help the achievement of this goal.

PEOPLE'S INCOMES ARE UNDERGOING MAJOR CHANGES

Only recently has the World Bank been able to collate sufficient data to place people from all countries in the world on the same common scale of personal income (gross domestic product per capita). Incomes are expressed in international dollars; an international dollar would buy in the cited country a comparable amount of goods and services as a United States dollar would buy in the USA (say, in 2005). Once estimated in this way, the incomes for all people in the world are ranked from the lowest to the highest and subdivided into groups. In the graph, the horizontal axis shows the relative position in the global income distribution. The percentile positions run from 5 to 95, in increments of 5; for example, 5 indicates the lowest 5% of world incomes, and so on until 95. The top 5% of the distribution is further subdivided into two groups: people between the 95th and 99th percentiles, and those in the top 1%. The vertical axis shows the percentage change (increase or decrease) in the real income for each of the groups.



Percentage change in real income between 1988 and 2008 at various percentiles of the global income distribution (calculated in 2005 international dollars).

The time evolution of incomes over the 20-year period shows a striking pattern. There was no improvement at all for those at the extreme left, i.e. bottom, of the scale: the poorest 5%. A remarkable improvement (up to an 80% increase) occurred for people who in 1988 were in the central 10th to 70th percentiles of the global income distribution. They include the large number of people who form the emerging global middle class: more than 200 million Chinese, 90 million Indians, and 30 million people each from Brazil, Egypt, and Indonesia. There was a minor improvement (of less than 10%), or even a decrease, for people who in 1988 were between the 75th and 90th percentiles

of the income distribution; essentially, these are the middle classes of the developed countries. Finally, a sharp increase occurred for those who were already the best-off in 1988, particularly the top 1% (an increase of 60%). In this respect, it should be noted that because the scales of the graph are relative, the same percentage increase corresponds to vastly different absolute increases in income: for a low annual income of 2000 international dollars, falling towards the left end of the graph, a 50% increase means a gain of 1000 international dollars between 1988 and 2008, whereas for people at the right end of the graph with annual incomes of 100 000 international dollars or more, the same 50% increase means a gain of 50 000 international dollars or more.

The dominant policies of the past decades are a mechanism that is capable of raising the income of large populations, but at the cost of generating new inequities (see “People’s incomes are undergoing major changes”). In particular, the persistence of extreme poverty and the increasing gap between a tiny minority of people with very high incomes (and wealth) and the rest of the population – a global pattern that is replicated within countries – may stretch to breaking point the ties between all members of a society, the very basis of

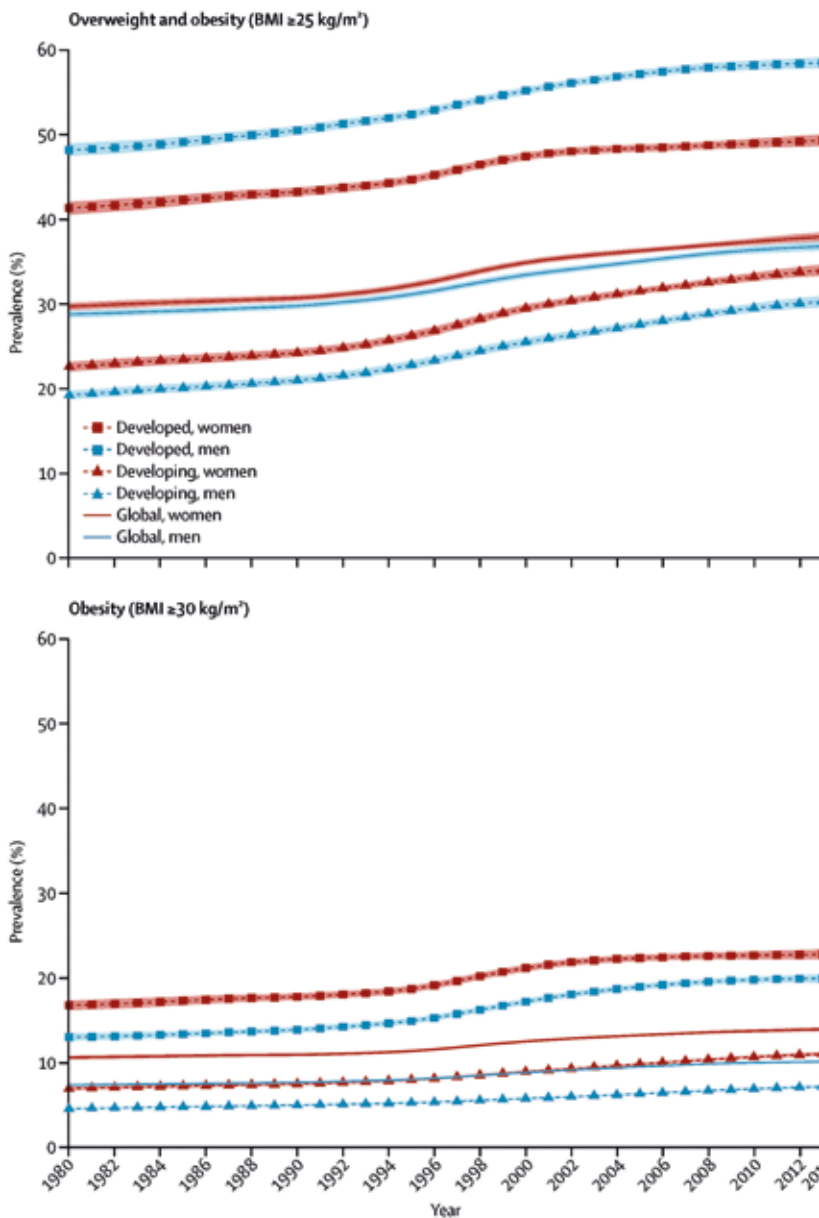

Obesity has been on the increase in developed countries as well as in many developing countries, and worldwide the prevalence of obesity has nearly doubled since 1980. In 2008, one third of adults aged 20 years or older (more than 1.4 billion adults) were overweight, and more than 10% were obese. In 2012, more than 40 million children under the age of 5 years were already overweight or obese.



solidarity rightly deemed by the Commission to be essential to remove health inequities. And social solidarity, stemming not only from private initiatives of philanthropists but above all from enlightened governmental actions, was also the foundation on which IARC was built.

IARC, a landmark scientific institution

In 2015, cancer has become a global health problem. The cancer incidence burden is projected to increase from 14.1 million new cases in 2012 to 21.6 million by 2030. It is estimated that by 2030 the worldwide burden of noncommunicable diseases, including cancers, cardiovascular diseases, chronic respiratory diseases, and metabolic diseases like diabetes, will have overtaken the burden of communicable diseases. The main reason for this is the rising burden of noncommunicable diseases, and cancers in particular, in developing countries, due to growing and ageing populations and to the spread of major cancer-causing factors like tobacco use, alcohol consumption, and obesity from unhealthy diets combined with the adoption of sedentary habits at home, at work, and in transportation. As a result, many developing countries are now confronted with the double burden of still-prevalent communicable diseases together with a rising incidence of noncommunicable diseases, including cancers. Whereas in the past attention has often been given to cancer in developing countries because of scientific interest, this new epidemiological situation means that the emphasis must shift towards supporting developing countries in their efforts to tackle what is becoming a major public health issue. Currently, for many cancers survival is markedly lower in developing countries than in developed countries, as exemplified in the table by 5-year survival in children at four locations. Improving the effectiveness of cancer diagnostic and treatment services is an obvious, if economically demanding, priority. Yet in a medium- to long-term perspective, the cancer problem can hardly be solved in this way in any country. In fact, population ageing, already well advanced in developed countries and catching up in developing countries, is bound to increase the number of cancers occurring each year worldwide, particularly among older people, the group for which gains in years of life from effective treatments come at the highest costs.

This perspective provides compelling reasons for prevention, aimed primarily at curtailing the number of cancers by avoiding their occurrence. When IARC was established in 1965, prevention was recognized as the key avenue towards cancer control because cancer treatments had definite but limited scope. Today, and most likely tomorrow, the escalating costs of cancer treatments – effective, or just promising – in ageing populations point again to prevention as the cornerstone of cancer control. IARC, an institution of comparatively modest size (about 300 people), has become an international landmark in the cancer research field because since the very beginning IARC's scientific programme has been designed to produce "knowledge for prevention". As the chapters of this book highlight, the programme has been articulated on two levels. The first level is developing tools and infrastructures for cancer research internationally, ranging from education and training of personnel in various areas of cancer research through

Percentage survival at 5 years after initial diagnosis in children (ages 0–14 years)
at four locations in different countries

Cancer type	Location (period)			
	Australia (1997–2006)	Shanghai, China (2002–2005)	Chennai, India (1990–2001)	Thailand (2003–2004)
All cancers	79.6	55.7	40.0	54.9
Leukaemias	80.6	52.2	36.3	57.4
Lymphomas	89.9	58.8	55.3	59.5
Central nervous system tumours	71.0	41.2	26.8	41.7
Neuroblastoma	67.8	—	36.9	33.6
Retinoblastoma	98.4	75.0	48.1	73.1
Renal cancers	88.6	86.7	58.0	70.4
Liver cancers	76.0	33.3	10.5	44.5
Malignant bone tumours	68.9	52.6	30.6	33.7
Soft tissue sarcomas	72.1	54.1	36.3	50.1
Germ cell tumours	89.4	78.4	38.0	70.6
Carcinomas and melanoma	93.3	88.9	35.1	—
Other	72.2	—	—	—

to establishing cancer resources like repositories of biological samples (biobanks) in different geographical settings. The second level spans several research axes, from analysing cancer occurrence data in order to gather hints about potential, not yet identified cancer causes to testing the efficacy and effectiveness of preventive interventions. The pressing need to improve the diagnosis and treatment of cancers in developing countries has fostered the inclusion in the programme of several screening and early diagnosis projects, although primary prevention targeted at removing causes of cancer remains a key objective of IARC's research activity.

IARC was born in 1965 as an initiative of a few economically developed countries in which cancer represented a major public health issue. Significantly, cancer research in developing countries, particularly epidemiology supported by laboratory investigations, was embedded in IARC's programme from the outset and immediately gave rise to several projects. Subsequently, some of IARC's greatest achievements, notably the studies leading to the identification of human papillomaviruses as the cause of cervical cancer and the vaccination trial to prevent chronic hepatitis and liver cancer, have taken place in developing countries. Today, when cancer is also becoming a relevant public health problem in developing countries, IARC is at the forefront of research in these areas of the world and is a prime example of solidarity between developed and developing countries.





EDUCATION AND TRAINING OF CANCER RESEARCHERS

EDUCATION AND TRAINING OF CANCER RESEARCHERS

Education and training of cancer researchers have been recognized as a paramount need and a key component of IARC's mandate since the very first formulations of its programme in 1965. At that time, training opportunities were available only at a limited number of leading research institutions in economically developed countries. In the field of epidemiology, formal courses and on-the-job training possibilities were even fewer, essentially restricted to the USA and the United Kingdom. IARC's international dimension prompted four main types of initiatives: international training fellowships, Senior Visiting Scientist Awards, international courses, and the development of educational materials. These have become continuing IARC activities aimed at providing the professional knowledge and skills considered necessary for "what comes next" in cancer research.

John Higginson welcomes the members of one of the first IARC Fellowship Selection Committees, in the meeting room made available by the City of Lyon.



INTERNATIONAL TRAINING FELLOWSHIPS

The Fellowship Programme was developed as one of IARC's very first activities. It was initiated in 1966, offering one-year training fellowships to young scientists with no previous postdoctoral experience, and has continued uninterrupted until the present day. Applications are reviewed and evaluated by an ad hoc IARC Fellowship Selection Committee composed of scientists, most of whom are from institutions other than IARC.

Stipends have kept pace with the cost of living and compare well with those provided by other granting organizations. IARC's core budget funds the programme; additional support has been provided in the past by the Italian Association for Cancer Research and in recent years by the European Union EC-FP7 Marie Curie Actions-People-COFUND programme (IARC Postdoctoral Fellowships) and by Cancer Council Australia (IARC-Australia Fellowships) and the Irish Cancer Society (IARC-Ireland Postdoctoral Fellowships).

Until 2004, fellowship recipients were selected regardless of their country of origin, and the host institution could be anywhere in the world. About 98% of fellows chose institutions in North America and Europe; the USA ranked first (about 50%) and the United Kingdom second (about 20%), followed by France, Sweden, Germany, and Canada. The desire to provide a unique training experience and the increasing public health relevance of cancer in low- and middle-income countries have informed some major changes in the IARC Fellowship Programme in more recent times. First, since 2004, fellowships have been tenable solely within one of IARC's research sections, with an extension for a second year possible, subject to satisfactory performance as evaluated by the Fellowship Selection Committee. Second, selection of fellowship recipients is driven by scientific excellence, but among equally meritorious applicants priority is given to candidates from low- and middle-income countries and to research projects relevant to such countries. This training format means that fellows are integrated into IARC research projects, often resulting in longer-term collaborations that extend well beyond the period of the fellowship.

“
Many
of my Italian
students became good
epidemiologists thanks to the
IARC Fellowship Programme,
which allowed them to spend
some years abroad.
– Benedetto Terracini,
long-term IARC
collaborator

Over the decades the number of candidates has varied around an average of 50 applicants per year, with peaks of more than 100. A total of 602 fellowships were awarded over the 49-year period 1966–2014, an average of 10–15 per year. In the early years (1966–1976), female fellows were a minority (about 10% of the total); their proportion has increased markedly, reaching 60% in the most recent period (2003–2014). The great majority of fellows (80–85%) return to their home country after the postdoctoral training. Most continue to work in cancer research, and it is significant that the three most recent IARC Directors – Paul Kleihues (1994–2003), Peter Boyle (2004–2008), and Christopher Wild (2009–present) – had been IARC postdoctoral fellows early in their careers – in 1970, 1981, and 1984, respectively – before progressing to prominent positions outside IARC.

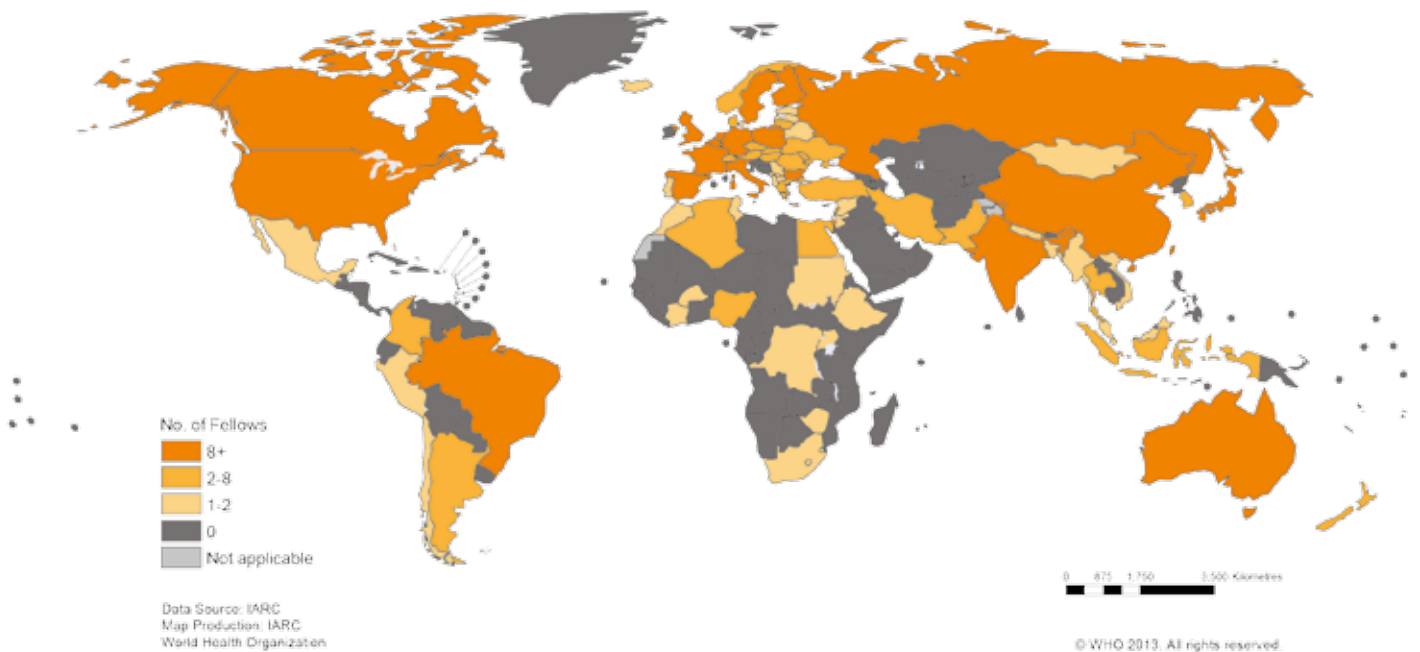

Countries of origin of IARC research training fellows (1966–2013). Over the years, the IARC Fellowship Programme has attracted postdoctoral scientists from an increasingly wide range of countries.

The distribution of fellowships by research area has reflected the evolution of disciplines within cancer research. Overall, two thirds of the fellowships have been allocated to the fields of epidemiology and biostatistics (24%), cell biology (18%), chemical carcinogenesis (12%), and viral carcinogenesis (11%), with the proportion for chemical carcinogenesis decreasing over time. The other third of fellowships have been in biochemistry and the growing sectors of genetics, molecular biology, and molecular pathology.

Further training opportunities at IARC arise through the recruitment of postdoctoral scientists, outside the Fellowship Programme, who are supported directly by extrabudgetary funds obtained mostly from

competitive grants awarded to specific IARC projects. The selection of these postdoctoral scientists (currently about 30 per year) is also approved by the IARC Fellowship Selection Committee, to maintain a uniform standard. In 2011, IARC introduced the Postdoctoral Fellowship Charter, an agreement that lays out what is expected of IARC, the supervisor, and the postdoctoral trainee, including participation in training courses in different core research skills such as grant writing, making presentations, bioethics, and biostatistics. In addition, an Early Career Scientists Association has been created by postdoctoral trainees and PhD students, bringing together students, fellows, and other postdoctoral scientists to promote social activities, to facilitate dialogue with IARC management, and to improve opportunities for career development.

“

My greatest achievement is the Fellowship Programme, because it is about bringing knowledge.

– Walter Davis,
former IARC staff member

Postdoctoral fellows don't spend all their time working. These members of the Early Career Scientists Association enjoyed a summer picnic in 2014.



Postdoctoral scientists coming to IARC enter an environment where people of some 50 different nationalities work together towards common goals through research projects conducted across the world. As a result of the collaborative nature of its work, IARC provides opportunities for interactions with scientists from all over the world, and every year IARC welcomes several hundred researchers who attend conferences, workshops, and research meetings. All of these networks offer postdoctoral scientists a remarkable introduction to world cancer leaders and a rich experience that helps equip and inspire them for their future careers. As a postdoctoral fellow from Mexico said recently, upon leaving IARC and returning home as the head of a new research group on molecular mechanisms of carcinogenesis, “It has been a very positive experience. The laboratory facilities are appropriate and up-to-date. The foremost value is the atmosphere at IARC, which favours exchanges between staff, fellows, and external scientists visiting the Agency; fruitful interactions take place easily and pave the way for future collaborations.”

SENIOR VISITING SCIENTIST AWARDS

A prominent feature of IARC's earliest years was the awarding of Travel Fellowships to senior cancer researchers, enabling international scientific exchanges during relatively short visits. In 1983, the Senior Visiting Scientist Award was established, offering scientists with a distinguished record in cancer research the opportunity to spend a longer period of 6–12 months at IARC with the aim of developing a collaborative project. Applications are evaluated by the same selection committee that assesses candidates for postdoctoral fellowships. To date, 44 awards have been made to scientists from 18 countries, more than half of them conducting research in a variety of areas within epidemiology and biostatistics. The presence and contributions of highly qualified external scientists have proven most valuable to strengthen the methodological approaches and widen the thematic perspectives of IARC's research teams. These awards have also been instrumental in reinforcing collaborative links with the visiting scientists' institutions.



Three recipients of the Senior Visiting Scientist Award (left to right): Neil Pearce from New Zealand, currently a professor at the London School of Hygiene & Tropical Medicine, received one of the first awards, in 1982; Jack Siemiatycki, now a professor of epidemiology at the University of Montreal, Canada, was an awardee in 1996; Leticia Fernández Garrote, a professor at the National School of Public Health, Havana, Cuba, was a recipient in 2013.

In a related development, the Expertise Transfer Fellowship was instituted in 2006 to enable established investigators to spend 6–12 months in an appropriate centre in a low- or middle-income country to transfer their knowledge and expertise in areas relevant to the host country and related to IARC's activities. To date, fellowships have been awarded to investigators from France, the Netherlands, Sweden, and the USA to visit Colombia, India, Uganda, and Uruguay to train PhD students in cancer epidemiology, to foster projects on cancer registration, and to investigate the relationships between viruses and cancer.

INTERNATIONAL COURSES

An annex to the very first IARC Annual Report (for 1966) stated: "In the short time since the establishment of IARC, its professionals came to recognize the dearth of competent epidemiologists and biostatisticians in the domain of cancer research. It would therefore be useful if the first of the international courses is devoted to 'Concepts and methods of cancer epidemiology'. It is hoped that the course can be organized in July 1968." The course took place in Lyon on 24 June–5 July 1968, with 30 participants, 23 of whom had all their expenses covered by IARC. Among the invited faculty members were Richard Doll and Donald Reid, who

Participants in the first course on cancer epidemiology in Lyon, in 1968. In the centre of the front row is Louis Pradel, then mayor of Lyon. To his right is Walter Davis, the IARC course organizer. Third from the right in the back row is the course's scientific director, Albert Tuyns, wearing dark glasses. At the extreme left of the photograph is Calum Muir, then head of the Unit of Epidemiology at IARC.





What is interesting to me today, as a senior emeritus professor, is to be invited by heads of cancer research units, for example in Barcelona or Rotterdam, and being told by all those people how important it was in their careers to have attended these short courses by IARC; it was their introduction to epidemiology.

– Norman Breslow, former IARC scientist

was a professor of epidemiology at the London School of Hygiene & Tropical Medicine.

That first course set the tone for what became one of IARC's most popular educational activities. Courses were organized by the IARC education and training professionals, with a faculty that was usually composed primarily of external scientists, joined by some IARC scientists. Participants were selected on the basis of qualifications and involvement in research, with attention paid to the resulting distribution by institutions and countries. Attendance was free. Whenever feasible, total or partial support to meet travel and accommodation expenses was provided by IARC.

These characteristics of IARC courses have remained fundamentally the same over the decades. From those early beginnings with one annual course, the programme developed and stabilized at the level of two to five courses per year, at least one of which took place elsewhere, often in a developing country (see "IARC courses in developing countries"). In the 40 or so years until 2004, 134 courses were organized, 77 of them away from Lyon, in countries spread over the continents. The number of participants has varied from an occasional low of 20 people to a high of about 80, with an average of 30–50 students, most of whom are qualified at postgraduate level. The most frequently covered topics have been epidemiology and biostatistics, with an emphasis on methodology. Other subjects taught have been chemical

John Cairns, an outstanding molecular biologist who made influential contributions to microbiology and cancer biology, took a keen interest in the societal and public health aspects of cancer. The most remarkable aspects of his lectures and conversations were the seeds of reflection that they invariably planted in the listeners.



carcinogenesis, virology and cancer, and mutagenesis. A successful series on the detection of environmental health hazards was presented in the 1980s and 1990s at venues in countries including China, Thailand, and Zimbabwe.

In its 50 years of activity, IARC has witnessed, and participated in, the revolution in biology, initially stemming from advances in molecular genetics. In the early 1980s, genes, whose presence could be inferred only indirectly through their influence on physical traits such as eye colour, blood group, or certain heritable diseases, became directly “measurable”. This was a huge change: for the first time, epidemiologists were able to investigate the effects not only of exposure to measurable environmental agents, like tobacco smoke, and of physiological traits, like weight or blood cholesterol, but also of inherited genes. To acquaint epidemiologists with the novel concepts and techniques of molecular biology, IARC organized a two-week course on “Molecular biology for epidemiologists” in Lyon in July 1986. Fifty epidemiologists attended the course, which was led by John Cairns, with a faculty composed of cellular and molecular biologists, geneticists, and virologists. The lectures were complemented by practical demonstrations of molecular biology techniques. The course was offered again two years later, at the Institute for Cancer Research in Oslo, and ushered in subsequent short courses in molecular epidemiology.

In 2005, the first IARC Summer School in Cancer Epidemiology was held in Lyon (see “The IARC Summer School in Cancer Epidemiology”). At the same time, there was a reorientation of the IARC courses; most of them became specialized (particularly in cancer registration and cancer screening), while some were upgraded to an advanced level (e.g. in statistics). From 2008 to 2014, more than 70 courses were held, two thirds of them in low- and middle-income countries, with a total of more than 2500 attendees.



A restriction fragment length polymorphism (RFLP) pattern from a 2001 IARC laboratory notebook. RFLP was the first widely used technique to determine variations (polymorphisms) in the DNA sequence between individuals. These variations show up as different bar patterns when a DNA sample is broken into pieces (digested) by enzymes and the resulting fragments are separated according to their lengths.

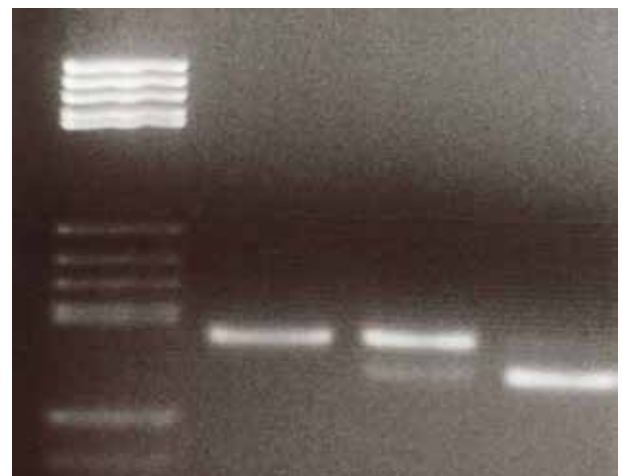

IARC COURSES IN DEVELOPING COUNTRIES

Walter Davis, who was for many years responsible for education and communication at IARC, recalls the “old days” of the IARC courses.

“In the 1970s, John Higginson was visiting potential countries where IARC could have collaborations. He went to China and told me, ‘You have to go there and tell them how useful epidemiology can be.’ I went and found myself in a room with maybe 50 people where I outlined what cancer epidemiology was about and how a course in epidemiology would be helpful for cancer research in China. They accepted the idea; it had to be approved politically and by the Academy of Science, and it was. So in 1979 we organized a course in Beijing. It was supposed to last four weeks, but it took longer because lectures were slowed down by the translation from English into Mandarin. The Chinese scientists attending the course were very interested in epidemiology and very hardworking. Giving training in China is a very good memory because of the attention and engagement of the students, even though the 1979 course was held in a hotel with no heating; it was so cold that Nubia Muñoz was wearing a fur coat while giving her lectures. In this course, like with other courses, there were one or two teachers from IARC, and all the others came from institutions around the world.



Participants in the IARC course on epidemiological methods held in Beijing in 1979.



Walter Davis was the enthusiastic organizer of a long series of IARC courses around the world. Here, during the 1987 session of the IARC Governing Council, Davis (right) talks to Nikolai Blokhin, who was director of the Institute of Experimental and Clinical Oncology of the Academy of Medical Sciences of the USSR and who served as chair of the IARC Scientific Council in 1970.

“Organizing courses in developing countries was complex. We had to send all the teaching materials, like books, in advance from Lyon. Given the local status of technology, on several occasions we had to send sets of perforated cards and card-sorting needles as tools for the statistical calculations. For a course in Yaoundé, Cameroon, these materials disappeared twice; it was quite stressful. The logistics were complicated because the aim was to recruit students not only from the country where the course was held but from the entire World Health Organization region. In Africa this meant most of the continent. We used to pay for travel and accommodation expenses with traveller’s cheques. I remember once a suitcase with 40 000 dollars’ worth of traveller’s cheques was lost – and eventually found, to our great relief.

“The spirit of IARC was to create a network of international contacts and potential research collaborations between developed and developing countries. In some developing countries, cancer epidemiology was non-existent and we had to plant the seeds through these courses.”

The “IARC spirit” that Davis brought to the courses in developing countries went – and continues to go – beyond the technical aspects, as expressed by a student at one of the most recent courses (a cancer registration course for Russian-speaking participants, held in Kazakhstan in September 2014): “Thank you for the opportunity to be a participant in this course and to acquire skills of working not so much with numbers – but with what they de facto mean, people, as well as their lives, our lives.”

For half a century, the wide geographical distribution of IARC courses has made training available locally in a substantial number of countries, providing valuable technical support for cancer research, particularly in epidemiology. The courses have also promoted the image of IARC as a key organization for international collaborative studies in the cancer field.

As with the postdoctoral training, the “benefit beyond measure” is the number of new collaborations, projects, and long-term friendships that result from sharing a learning environment with other similarly motivated colleagues from as far apart as Chile and China, or South Africa and Sweden. One should not underestimate the encouragement and impetus that springs from such relationships formed during time spent together at a course.

“
*Our science was isolated.
 But IARC broke the isolation
 of cancer research. A lot of young
 Russian scientists became high-ranked
 specialists after working at IARC.
 Because it is international, IARC gives
 equal possibilities to everybody.*
 – Vladimir Anisimov,
 long-term IARC
 collaborator

Locations of IARC international courses (2008–2013). Since the first Summer School was held in Lyon, the IARC courses have been reoriented and are centred particularly in East Asia and Latin America.

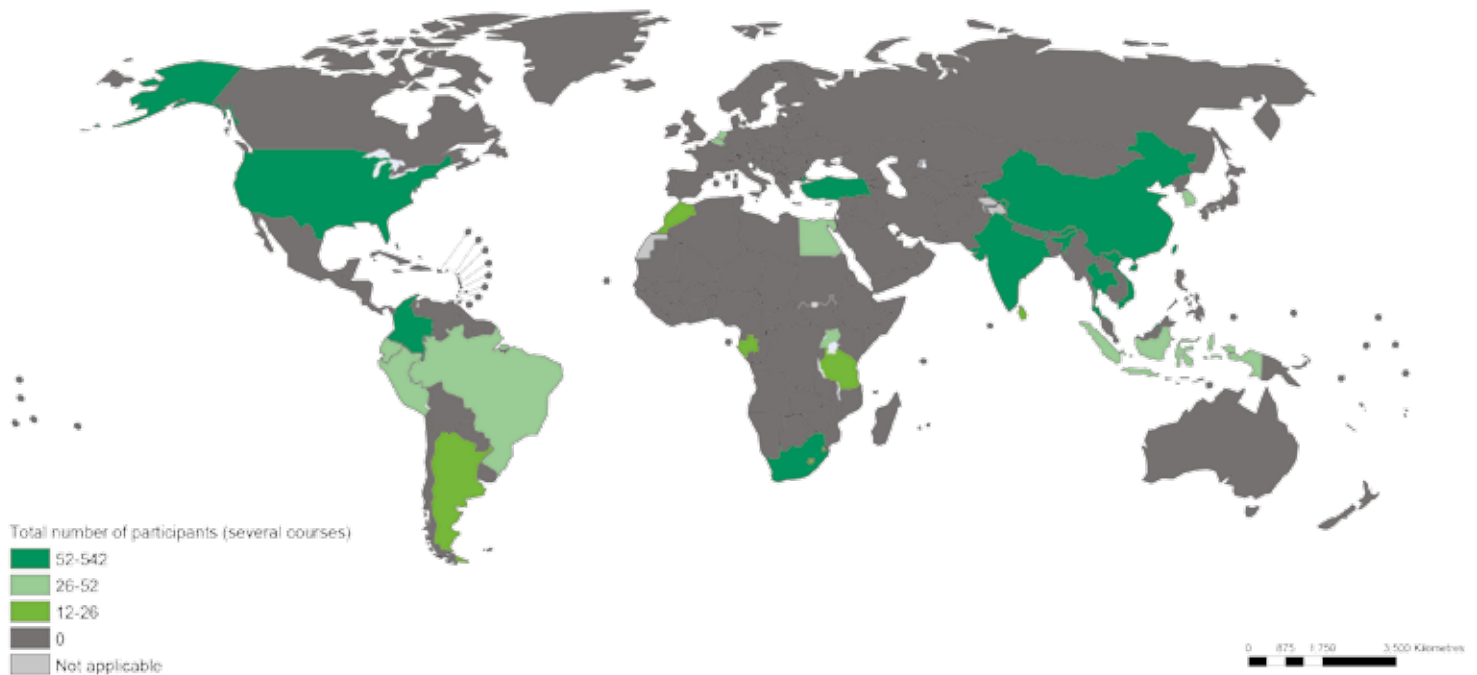

Data Source: IARC
 Map Production: IARC
 World Health Organization

© WHO 2013. All rights reserved.

THE IARC SUMMER SCHOOL IN CANCER EPIDEMIOLOGY

The Summer School began in 2005 at the initiative of the then IARC Director, Peter Boyle, with the dual focus of training researchers from developing countries and opening up opportunities for them to become active participants in international collaborative studies. In its first 10 years, the Summer School was organized into two modules: cancer registration (week one) and cancer epidemiology (weeks two and three).



Peter Boyle, here lecturing on epidemiology to Summer School students, was the IARC Director from 2004 to 2008. During his tenure, four countries (Austria, India, Ireland, and the Republic of Korea) became IARC Participating States, strengthening the platform of support and the opportunities for scientific collaborations.

On average the Summer School has accepted 65 students per year, with 40 in the first module and 40 in the second, including about 20 people who complete both modules. More than 600 students have come to Lyon to participate, with a wide geographical distribution. Participants from low- and middle-income countries (more than 90% of all students) are exempted from any course fees. In addition, total or partial coverage of travel and living expenses may be offered depending on availability of funds; over the years, financial support has been provided by the United States National Cancer Institute, the Nordic Cancer Union, the Union for International Cancer Control (UICC), and the Bullukian Foundation.

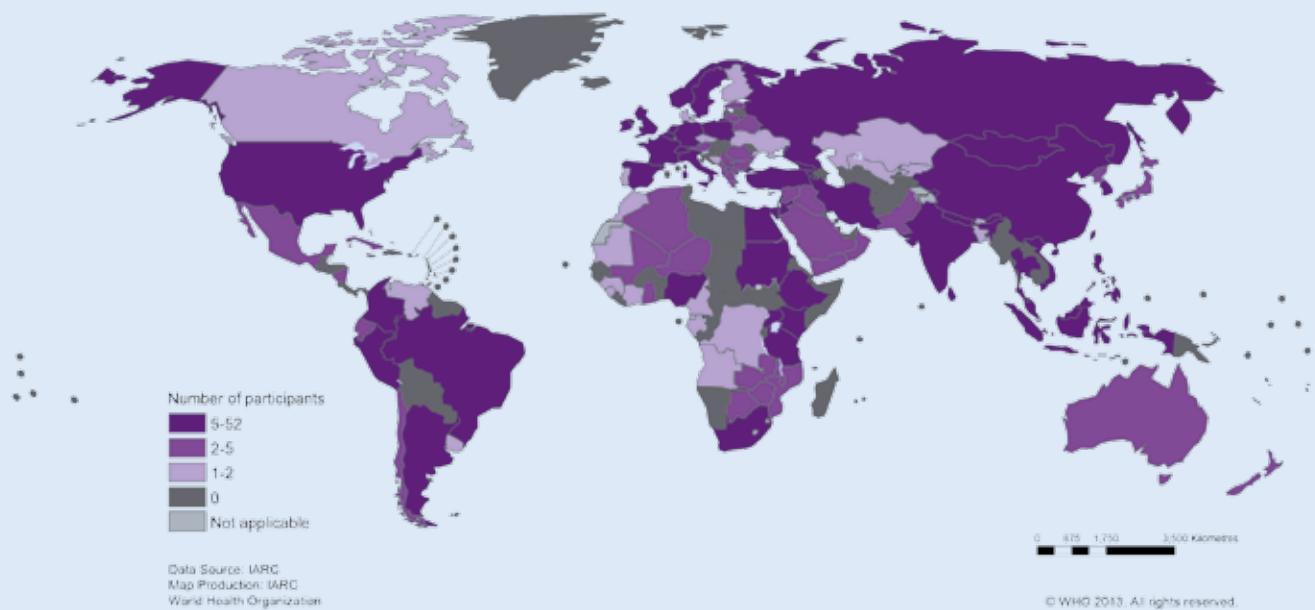

Countries of origin of IARC Summer School participants (2005–2013). Students come to the Summer School from all over the world.

The Summer School has been very successful, as judged by the students: a survey of participants in the early years showed that more than 90% were able to apply what they learned in their job. Most of the participants considered that the Summer School had been either helpful (73%) or decisive (23%) to their careers, an assessment confirmed by these comments made by participants in recent years.

It was a very educative course and good for me as a clinician as I try to boost the research capacity for our new cancer unit and promote collaboration with other researchers and the local cancer registry. – Leo Masamba, Chief Oncologist, Ministry of Health, Queen Elizabeth Hospital, Malawi (2014)

I will use and share the knowledge on cancer epidemiology and cancer registration to develop a national cancer control and prevention programme. – Badamsuren Tseveen, Head of Research, Education, and Cancer Registration, National Cancer Center, Mongolia (2014)

The first thing I want to do is to share the knowledge with my colleagues at work (Children’s Cancer Hospital Egypt) and my colleagues at the National Cancer Institute (NCI Cairo). I hope that together we will be able to implement two things. The first is to establish a national network for childhood cancers (for cancer registration, biosample storage and collection, standardization of treatment protocols, and clinical research). The second is to establish a similar summer school in Egypt for students of medical sciences and fresh graduates. – Mohamed Sabry Bakry, Head of Biostatistics and Research Informatics Unit, Children’s Cancer Hospital, Cairo, Egypt (2013)

THE “BLUE BOOKS”

Among the materials produced by IARC, the so-called “Blue Books” series (from the colour of the cover), on the histological and molecular classification of tumours, occupies a prominent position. The books are of value for education, research, and clinical pathology practice. Well-defined histological and clinical diagnostic criteria are indispensable for clinical and epidemiological cancer studies, and in 1956–1957 the World Health Organization (WHO) initiated a programme aimed at producing an international classification and grading of tumours that would be accepted and used worldwide. Indeed, classification of tumours was one of the topics considered for the new cancer agency in the early 1960s, before its creation at the World Health Assembly in 1965 (see the chapter “The birth of IARC”). There was also an obvious need for the histological classification of tumours in laboratory animals to be standardized, particularly for use in long-term carcinogenicity experiments (see the chapter “Carcinogens in the human environment”). In 1973, IARC published the first of a series of reference books, *Pathology of Tumours in Laboratory Animals*, coordinated by Vladimir Turusov. Successive volumes dealt with tumours of the rat, mouse, and hamster. Demand was high; the books were reprinted, and a second edition followed in the 1990s.



Paul Kleihues (left) at IARC with Jean-François Mattei, then French Minister of Health, Family, and the Disabled. Kleihues was the IARC Director from 1994 to 2003. His tenure coincided with a cancer research environment undergoing revolutionary changes, culminating in the Human Genome Project. He adapted IARC's laboratory activities to this new environment, encouraging connections to IARC's major epidemiology projects. A distinguished neuropathologist, he continued his personal involvement in research on the molecular genetics of brain tumours.

The WHO classification of human tumours began with the first edition (1967–1981), which was essentially based on histological typing. The second edition was led by WHO (1982–2002), until fresh impetus was energetically provided by Paul Kleihues during the 1990s. IARC took responsibility for the third edition (2000–2005), and Kleihues collaborated with Leslie Sobin, editor of the first two editions. It was Kleihues who introduced the transformative information coming from the molecular characterization of human tumours. Each volume of the series is prepared by a group of often more than 100 internationally recognized experts convened by IARC. The “Blue Books” incorporate histology, immunohistochemistry, and genetic tumour profiles as features for diagnostic definition and malignancy grading. They also contain concise sections on epidemiology, clinical signs and symptoms, imaging, prognosis, and predictive factors, making each volume, 250–500 pages long, a compact and comprehensive reference, wonderfully illustrated (see “The WHO Classification of Tumours of the Central Nervous System”).

The complete WHO Classification of Tumours series, of which IARC is now producing the fourth edition, currently includes 11 volumes, covering tumours of the central nervous system; the skin; haematopoietic and lymphoid tissues; endocrine organs; soft tissue and bone; the head and neck; the digestive system; the lung, pleura, thymus, and heart; the breast; female reproductive organs; and the urinary system and male genital organs (see whobluebooks.iarc.fr). Rare is the pathology department anywhere in the world that does not contain one or more volumes of the “Blue Books”. The quantity distributed – about 15 000 copies per year – is a testament to their widely acknowledged value. The books are at the heart of IARC’s broader publishing activities, underpinning other areas of research, including cancer registration (see the chapter “Cancer

registries: a worldwide endeavour”), biostatistics (see the chapter “Innovation in statistical methods”), and epidemiology (with the comprehensive volume *Molecular Epidemiology: Principles and Practices*, published in 2011 and led at IARC by Paolo Boffetta and Pierre Hainaut, and the preparation of a new edition of the textbook *Cancer Epidemiology: Principles and Methods* by Isabel dos Santos Silva, first published in 1999). The Education and Training Programme website (training.iarc.fr) offers an overview of recorded presentations, reference books, and practical manuals produced by IARC.

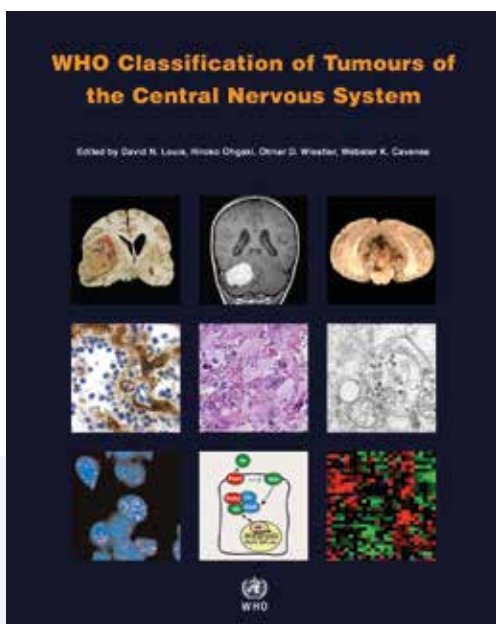

THE WHO CLASSIFICATION OF TUMOURS OF THE CENTRAL NERVOUS SYSTEM

Tumours of the central nervous system were addressed in the first volume of the fourth edition of the “Blue Books”. In this book, as in all others in the series, the text is accompanied by extensive illustrative material. Glioblastoma is the most frequent primary brain tumour. Today its presence can be visualized by magnetic resonance imaging (MRI), but the diagnosis is established by microscopic examination, which reveals characteristic histological features.

Glioblastoma is only one in a list of nearly 130 histological varieties of malignant and benign nervous system tumours within the WHO classification. For brain tumours, as for tumours of any other organ, a detailed characterization of the varieties based on histological and genetic features may help in pinpointing types that have different causes as well as in distinguishing types with different responses to specific treatments. The *International Classification of Diseases for Oncology* (ICD-O) (see the chapter “Cancer registries: a worldwide endeavour”) makes use of the “Blue Books” information and nomenclature to the maximum extent possible.

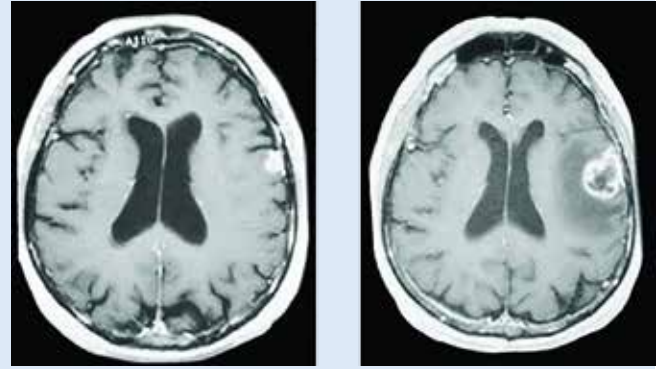

Rapid evolution of a primary glioblastoma. Magnetic resonance imaging (MRI) shows (left) a small cortical lesion (white spot) that within 68 days developed into a full-blown glioblastoma (right).

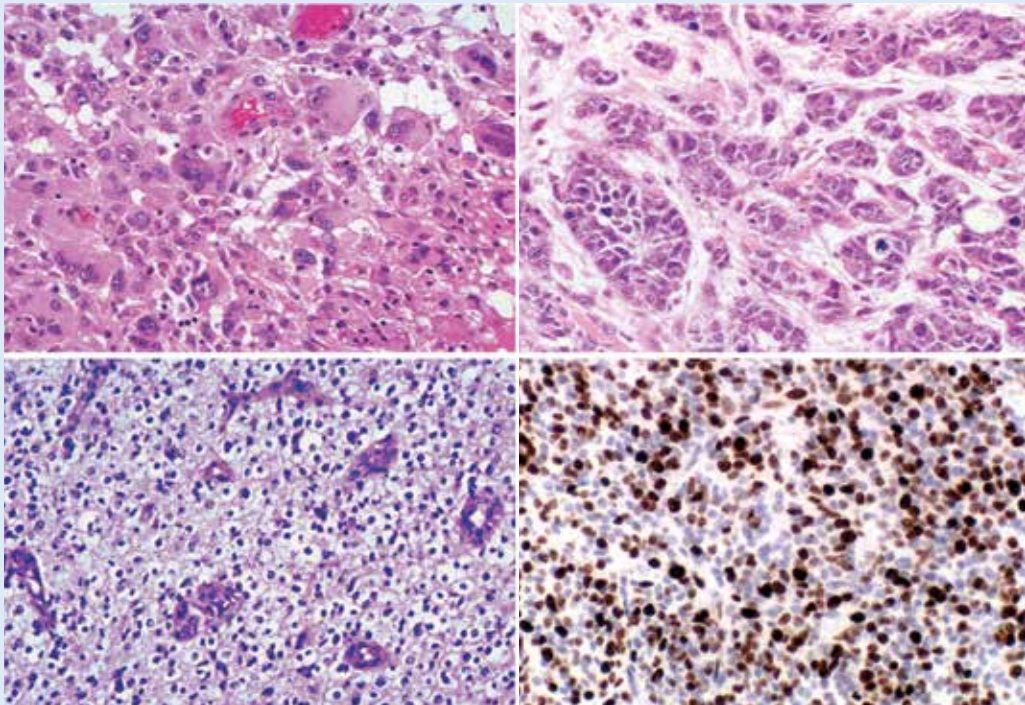

These microscopic images of tumour samples show various morphologies of glioblastomas.

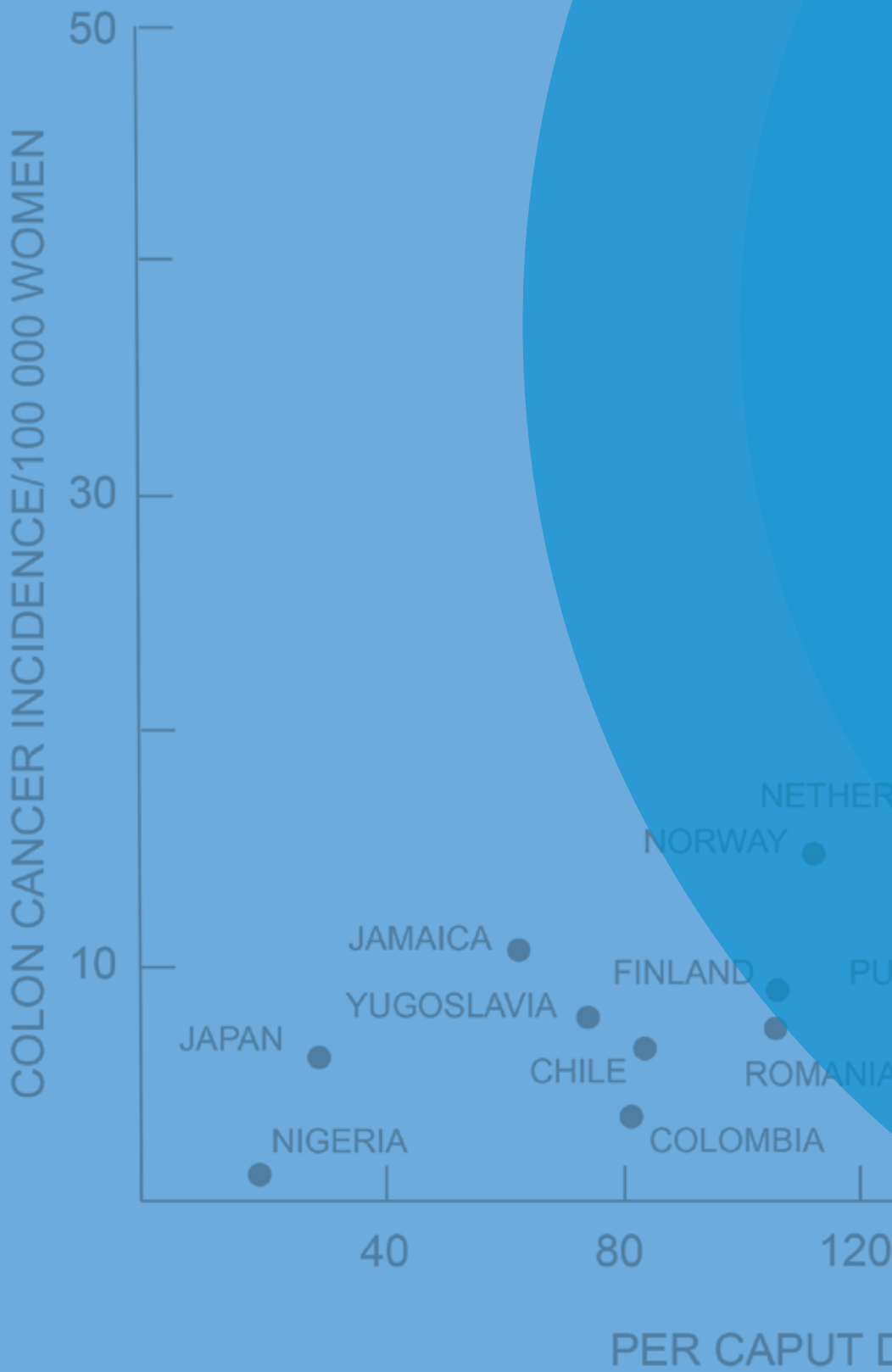

INNOVATION IN STATISTICAL METHODS

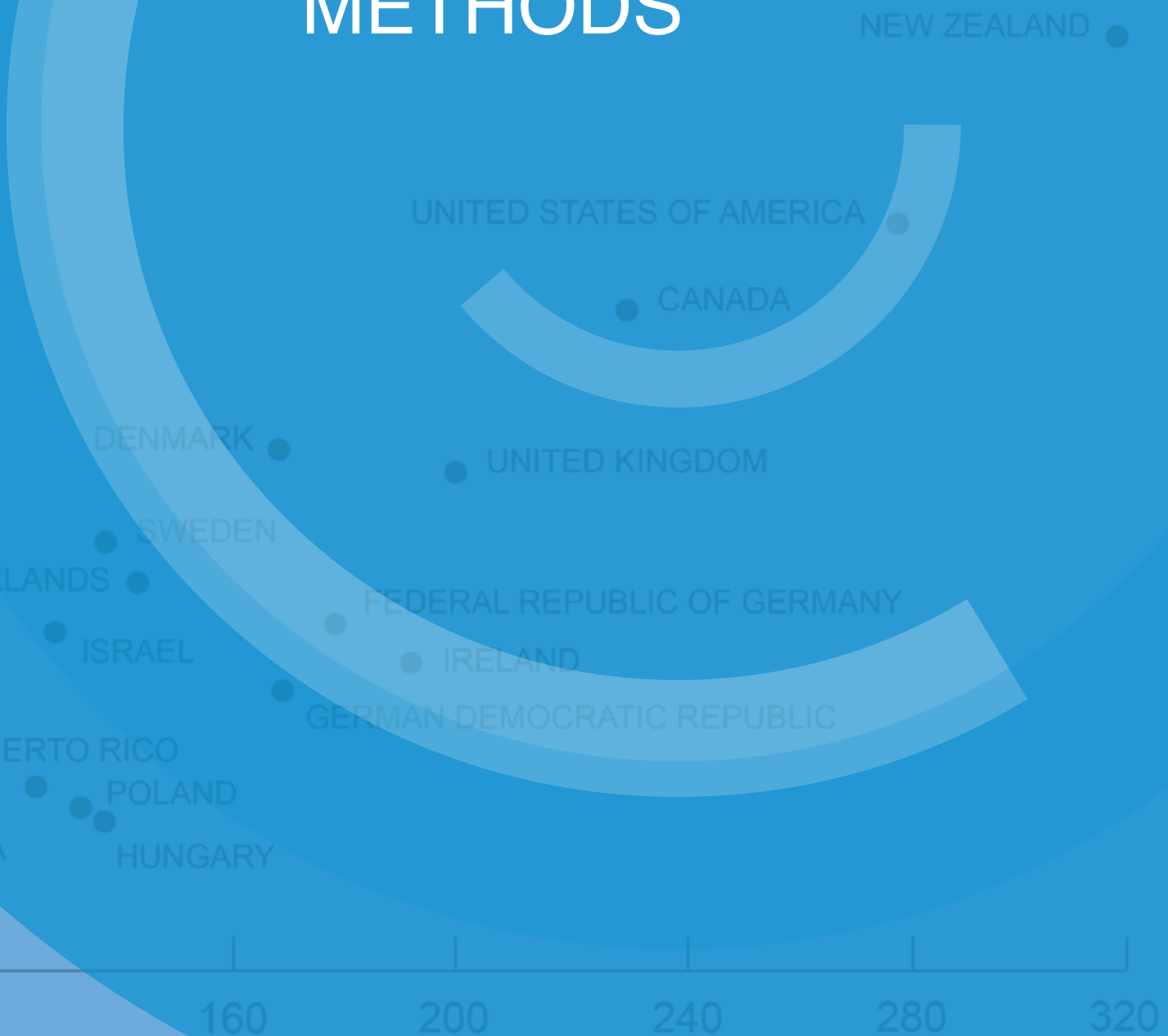

DAILY MEAT CONSUMPTION - GRAMS

INNOVATION IN STATISTICAL METHODS

At the time when IARC was established, in 1965, there was an obvious need for competence in the design and statistical analysis of laboratory experiments and epidemiological and clinical studies of cancer, and of diseases generally. This need was hard to meet because of a shortage of qualified people, exacerbated by the demands of developing methods well suited to studies of noncommunicable diseases and of mastering the potential of electronic computers, recently introduced and still unfamiliar.

To meet this need, work on several main topics in statistical methodology was soon initiated within IARC's areas of research. The conditions at IARC, like at other institutions, reflected the status of information technology in the late 1960s and early 1970s. Jacques Estève, who was the head of information technology at IARC at that time, recalls: "I had to introduce the first data management system. In the first years of IARC, things had been pretty disordered. The epidemiologists were unhappy as they had great difficulty in retrieving their data; once they were entered into the computer, how to access them was a kind of practical mystery. The computer installation to support the new data management system occupied a large room, and provided much less computing power than today's smallest laptop. Yet over a few years the data management performance was transformed for the better." This was only the first of a series of transformations that kept IARC's computing system on a par with the constantly evolving technology.



Students at work with mechanical calculating machines, the tools usually available in the late 1960s for statistical analyses of epidemiological data sets. Beyond the four arithmetic operations, these machines could calculate the sum of a sequence and the sum of the products of two sequences of numbers.

A UNIFIED FRAMEWORK FOR EPIDEMIOLOGICAL STUDIES OF CANCER ETIOLOGY

Epidemiological studies aimed at investigating causes of cancer were – and are – at the core of IARC's research. The development at IARC of statistical methodology for etiological studies produced notable results, some of which have proven to be of lasting value as they still serve as key references. This applies especially to *Statistical Methods in Cancer Research*, by Norman Breslow and Nick Day, published in two volumes: *The Analysis of Case–Control Studies* in 1980 and *The Design and Analysis of Cohort Studies* in 1987. The book is still available on the IARC website and is, quite reasonably, characterized as a classic text in the field (see “Frontline statistical research: Norman Breslow and Nick Day”).

Several factors combined to make the book a success. First, it was timely. The title refers to cancer research in general, but in fact the book deals essentially with statistical methods for cancer epidemiology (although some of the methods, such as survival analysis, can also be applied to animal experiments). In cancer epidemiology, methodological innovations had been flourishing since the 1950s, aimed at solving specific problems of data analysis. However, the connections between the different new methods were not obvious, and their relative merits and limits of applicability were not well defined. In Breslow and Day's book, these methods, which had been scattered among articles in statistical and epidemiological journals, were critically reviewed and related to one another in a logically coherent framework. Second, in doing so, the authors frequently used original results from their own methodological research. Third, the presentation was at a

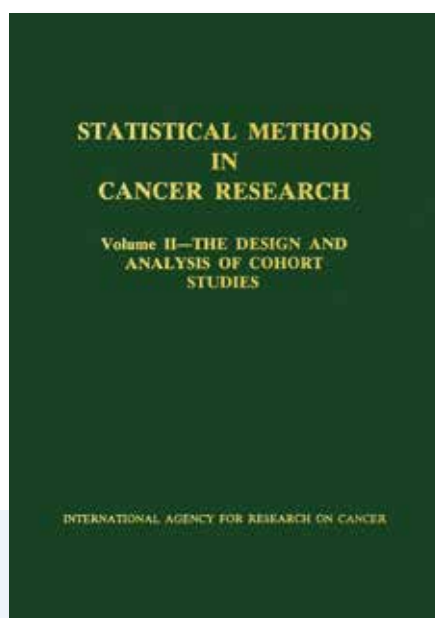
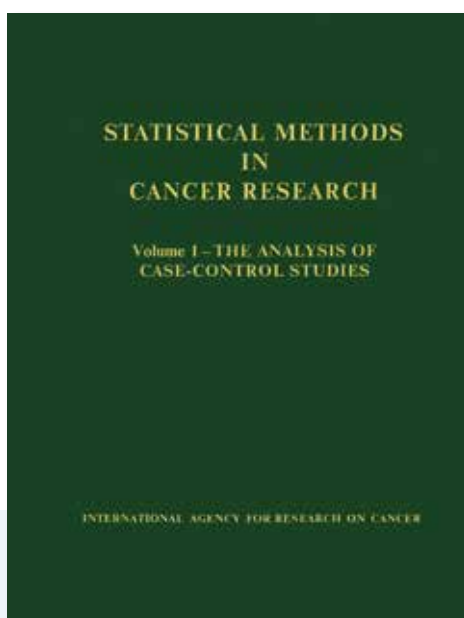



Simone Veil, then French Minister of Health, visited IARC on 3 November 1975 to open a symposium on environmental pollution and carcinogenic risks. Here, Nick Day shows Veil a computer display of epidemiological data analyses. Between 1970 and 1986, Day and his team made IARC a world-leading centre in biostatistics. Day subsequently moved to Cambridge, United Kingdom, where he spent the second part of his career as a professor of public health and epidemiology.

FRONTLINE STATISTICAL RESEARCH: NORMAN BRESLOW AND NICK DAY

Nick Day, who is now retired and lives in Guernsey, remembers the statistical work: “The two monographs on statistical methodology played a central role for me, particularly the first one, on case–control studies. Such studies were the mainstay of cancer epidemiology at the time, and there were numerous papers, and even books, on their theory, design, and analysis. It was all a bit of a mess, with little coherence. Norman Breslow and I saw that basic statistical developments in the 1970s could provide a coherent underlying structure for case–control studies, the theoretical basis if you like, which led directly to methods that could be generally applied. We then went ahead and wrote the case–control volume. It quickly gained wide acceptance, and was translated, in whole or in part, into a number of languages. A few years ago, a review appeared in the *American Journal of Epidemiology* identifying the most widely quoted publications in the journal in the previous 25 years. Our book was at the top of the list, by a long way.”

Norman Breslow, who now divides his time between Seattle and Provence (France), adds, “The case–control volume turned out to be a very successful effort, way beyond our wildest dreams in terms of how it was accepted as a textbook within the community of epidemiologists and biostatisticians. It had not been intended as a textbook – it was a research monograph to reveal the latest developments in biostatistics as related to epidemiology, and relied very heavily on research work that Nick Day and I were both involved in in Lyon at the time. I think it had an impact because of the level it was oriented towards: not a theoretical statistical text nor an epidemiology text spending a lot of time on a line of study and the development of questionnaires, collection of data, and that sort of thing. It was addressed towards mathematically qualified epidemiologists and also statisticians. For example, in about 1980 I started in Seattle a course directed towards second-year epidemiology students, PhD students, and first-year master’s students in biostatistics, and we used the case–control monograph as a textbook. It was very successful, and I imagine that similar courses happened at many other universities, but epidemiologists, too, liked the book because it used real data, real examples – it did not dwell on mathematics aspects but tried to emphasize what was useful in answering questions of interest to them.”



Norman Breslow enjoys returning to IARC (here attending a recent seminar), where he worked for four years during the 1970s, closely collaborating with Nick Day, in particular on the production of their book on statistical methods for cancer research. At the School of Public Health of the University of Washington, Seattle, USA, Breslow founded and developed a first-class biostatistics department, where he is currently professor emeritus.



In 1972 WHO had installed an IBM 360, which at the time was a very powerful computer. We wrote programs in FORTRAN and prepared a set of Hollerith cards to instruct the computer how to analyse the data, followed by 600 or 1000 data cards. I would rise at 5:00 am, walk up to the Gare des Brotteaux in Lyon, get on the overnight train going from Barcelona to Copenhagen, with a stop in Geneva, where I would have breakfast in Gare Cornavin, take a bus up to the WHO headquarters, work all day feeding my cards into the machine, and then in the evening I would reboard the train to Lyon.

– Norman Breslow, former IARC scientist

level that respected theoretical and formal rigour while being mostly accessible to readers with a limited mathematical background. Fourth, and most importantly, the statistical analyses were illustrated step-by-step by applying them to real data from epidemiological studies. This was uncommon in the methodology books then available, and even in those published later. A strong connection was maintained between the methods and the substance of epidemiological investigations, such as studies of the relationship between alcohol consumption and oesophageal cancer, hormones and endometrial cancer, or ionizing radiation and lung cancer.

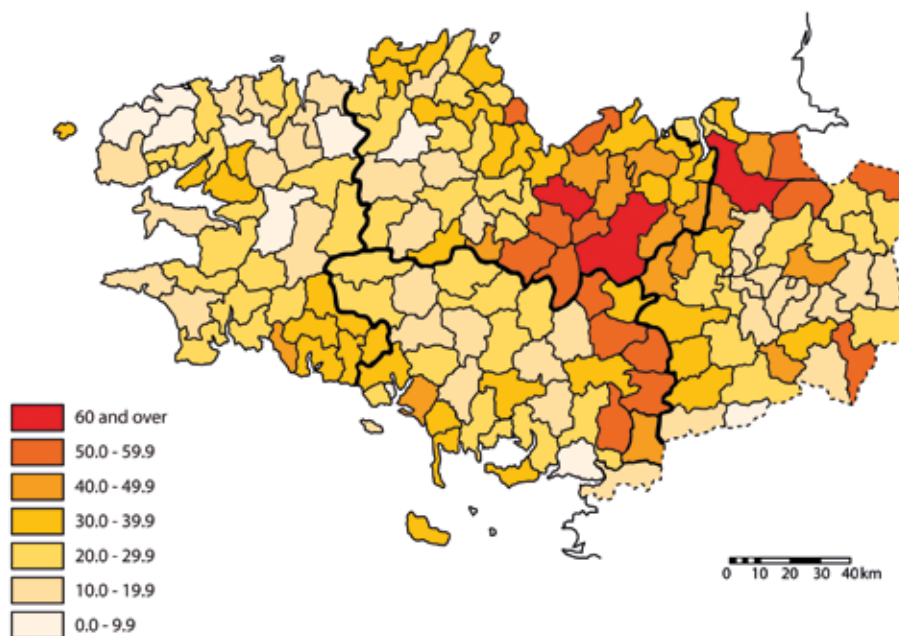

Mortality rates for oesophageal cancer in the Brittany region (deaths per 100 000 population per year during 1958–1966), by canton. Rates in Brittany were markedly higher than the average rates in France. Within the region, major variations occurred among cantons. A relationship with different levels of alcohol consumption was suspected, and epidemiological studies were initiated to test this hypothesis.

ANALYSING ANIMAL CARCINOGENICITY EXPERIMENTS

Typically, animal carcinogenicity experiments involve exposing groups of animals (e.g. rats) to a substance (e.g. a chemical whose molecular structure makes it a suspected carcinogen) and following them up and recording the numbers of observable tumours in various organs. If the substance is indeed carcinogenic, more tumours will be observed among the exposed animals than among a comparable group of unexposed animals (controls).

However, the tumours may become observable in very different ways: because they affect the skin or visible mucosa, because they affect an internal organ and they cause the animal's death, or because the apparently healthy animals are sacrificed at a fixed time. A naive way of counting the tumours, not at all uncommon in the literature, is to simply tally all the tumours, irrespective of the way in which they were observed. However, this may lead to grossly wrong conclusions in the comparison between exposed and unexposed animals. It is intuitive that a tumour found at autopsy when an apparently healthy animal is sacrificed has a different relevance than a tumour that has already caused the animal's death. The differently observed tumours need to be counted and compared separately. This requires sophisticated statistical analysis capable of combining the results of the separate comparisons between exposed and unexposed animals.

These methods have an interesting relationship to what we can or cannot observe in human populations. When we focus on a single cause of death (e.g. lung cancer), what we can actually observe are those deaths from lung cancer that have not been precluded by earlier deaths from all other causes. In animal experiments, the sacrifice of animals at fixed times has a similar role to all other causes of death in human populations. As in animal experiments, after earlier deaths from other causes, some lung cancers can be found at autopsy. In animal experiments, the fixed times of sacrifice are the main determinant of the average age at death of the animals. Similarly, it is mainly the ensemble of all other causes of death – rather than the single cause of death of interest (lung cancer) – that determines the average age at death of people dying of lung cancer. This is contrary to what might seem to be the case at first glance.

A 2014 survey of books on epidemiological and statistical methods in the biomedical literature showed that Breslow and Day's book currently receives 100–200 citations per year in research contexts, as a reference for now well-established methods or for teaching purposes (see "Case-control studies"). The Breslow–Day test, first introduced in the book, is often found in research papers as a statistical test of whether risk (e.g. of lung cancer in smokers compared with non-smokers) is the same in different subgroups (e.g. men and women).

In Breslow and Day's book, cancers were considered as occurring in a cohort of people specially assembled to study the causes of cancer. One can also consider cancers, or deaths from cancers, occurring in populations within defined geographical areas, or cancer-related deaths or recurrences of cancer occurring in groups of patients. Statistical methods to deal with these two situations were presented in 1994 in an IARC book co-authored by Jacques Estève, *Statistical Methods in Cancer Research: Descriptive Epidemiology*. It details methods for analysing data as typically gathered by cancer registries, including examining how cancer occurrence evolves over time, as well as geographical variations in cancer frequency and their

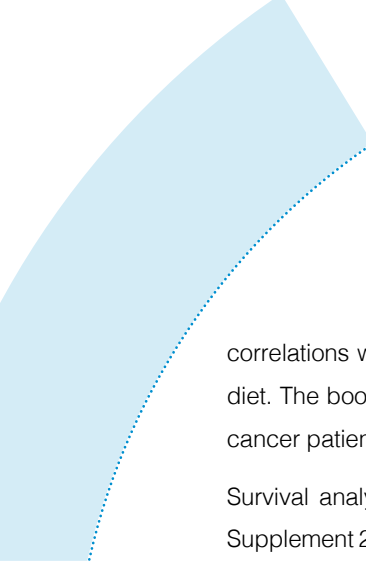

correlations with geographical variations in factors such as income, air pollution, alcohol consumption, and diet. The book also covers a key topic for evaluating the effectiveness of cancer treatments: the analysis of cancer patients' survival.

Survival analysis is also at the core of animal experiments to test whether a substance is carcinogenic. Supplement 2 of the IARC Monographs on the Evaluation of Carcinogenic Risks to Humans, published in 1980, has a 100-page annex on statistical methods, produced collaboratively by IARC and external statisticians. This annex highlights with great clarity how findings from carcinogenicity experiments in animals should be correctly analysed (see “Analysing animal carcinogenicity experiments”). A substantial expansion, with a focus on formal statistical models of analysis, followed in 1987 with the IARC book *Statistical Methods in Cancer Research: The Design and Analysis of Long-Term Animal Experiments*, of which Jürgen Wahrendorf was the senior co-author. The issues developed in these publications are a further example of the value of IARC's contributions to the analysis of cancer data and are relevant not only for cancer research but also for long-term toxicological experiments in general.

CASE-CONTROL STUDIES

The observation of a high frequency of oesophageal cancer in the Brittany and Normandy regions of France raised a question: Could this be due to the notoriously high consumption of alcoholic beverages (some of high proof, typical of these regions), or to tobacco smoking (as suggested by previous studies in other parts of the world), or to both? A first, relatively quick answer to this question would come from finding out whether people with oesophageal cancer in fact drank more alcoholic beverages or smoked more than healthy people of the same age and sex.

A study to address this question was organized in hospitals of Ille-et-Vilaine, a department of Brittany, between 1972 and 1975. It included 200 patients affected by oesophageal cancer (“cases”) and 778 unaffected people (“controls”) from the communes of this region. In this typical case-control study, the usual consumption of wine, beer, and spirits was assessed by interviewing the study participants using a standardized questionnaire. The quantity of the different beverages was converted to grams of alcohol per day. The results were clear: the majority (85.5%) of the patients with oesophageal cancer had consumed 40 grams or more of alcohol per day, whereas only about half (50.2%) of the controls had.

It seems reasonable to infer that a person who currently drinks more alcohol than somebody else is at a higher risk of developing oesophageal cancer in the future. But how can we obtain the actual measure of interest, the risk of future cancer for different levels of alcohol consumption, when we only have data on cases (plus controls) that have already occurred? Do we need to carry out a cohort study assessing alcohol consumption in a large group of people and following them up for 20 or 30 years to see how many cases of cancer occur in the different categories of consumption? Indeed, this is the direct measurement needed to conclude that alcohol causes oesophageal cancer. However, it turns out that there is no need to wait many decades; essentially the same risk measure can be derived for a given population from either a case-control study or a cohort study. A formal justification of this seemingly magical solution had been put forward in the early 1950s. The book *Statistical Methods in Cancer Research* placed it within a coherent logical and probabilistic framework, showing that case-control studies (treated in Volume 1 of the book) are basically equivalent to cohort studies (treated in Volume 2). In practice, this equivalence holds provided that some conditions are satisfied, particularly concerning the way in which cases and controls are selected.

This fundamental development in methodology, presented in Breslow and Day's book, unifies the different study designs. This made it possible to use the same, rather than disparate, statistical methods of data analysis to deal with issues arising from these studies. For example, a study in which subjects with different levels of alcohol consumption are compared would need to control for extraneous factors (e.g. tobacco smoking) that might produce a false effect of alcohol or influence its strength of effect. In fact, as the graph shows, people who have a high consumption of alcoholic beverages (equivalent to 81 grams or more of alcohol per day) and also smoke 20 or more cigarettes per day – represented by the column at the extreme right of the graph – have a risk of oesophageal cancer more than 40 times that of people who consume 0–40 grams of alcohol per day and smoke 9 or fewer cigarettes per day (the extreme left column of the graph).

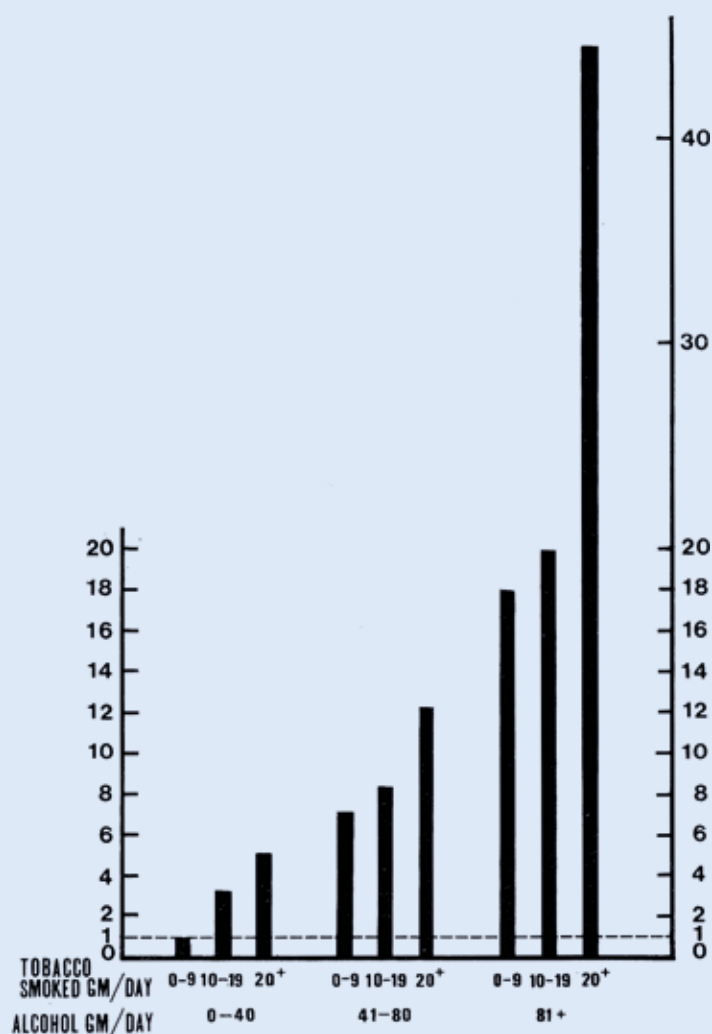

Relative risk of oesophageal cancer in Ille-et-Vilaine, a department of Brittany, by categories of daily tobacco smoking and alcohol consumption.

A NOVEL EPIDEMIOLOGICAL STUDY DESIGN

Reliable data analysis does not depend only on statistical methods; these are highly dependent on the way in which the data have been collected, and hence the design of a study matters as much as the analytical approach. The Gambia Hepatitis Intervention Study ranks among IARC's key projects. Its substantive relevance for establishing the etiology of liver cancer and testing the preventive effectiveness of the vaccine against hepatitis B is outlined in the chapter "Viruses and vaccines". Equally important from a methodological viewpoint was its novel study design.

The Gambia Hepatitis Intervention Study originated in the mid-1980s under particular circumstances. A vaccine was available that was known to be effective against hepatitis B. The research question was whether preventing hepatitis B infection (i.e. preventing newborns from becoming carriers of the hepatitis B virus) would prevent the later occurrence of primary liver cancer. Initially, it seemed that the only ethically admissible way to answer this question would be to start administering the vaccine to all newborns in a given year and then compare (several decades later) the liver cancer occurrence in vaccinated people with that in the unvaccinated people who were born before the vaccination programme started. This is known as a "pre-post" comparison. Such an approach is fraught with potential biases because many other factors, which vary over time and have nothing to do with the vaccine, could induce a change in cancer occurrence and detection.

The study design was considered ethically uncontroversial, as confirmed by the IARC Ethics Committee, which had recently been established (see "The IARC Ethics Committee"). But the design was scientifically weak, a serious handicap considering the considerable investment of resources that would be demanded by the project over a projected 40-year period. However, one major practical constraint to vaccine delivery soon emerged that was turned into a scientifically strong study design. In fact, it would have been logistically impossible to start administering the vaccine to all newborns in The Gambia in a given year – more than 60 000 newborns, scattered across rural areas. The only feasible procedure was to introduce the vaccine gradually over several years.



What impressed me enormously was the Gambia hepatitis B programme and the absolute commitment of the Director at the time to ensuring that IARC could continue vaccination after the numbers needed in the vaccinated and unvaccinated groups were complete. Most researchers would say, "We will now continue with our research programme and we're very sorry but you'll have to go and look elsewhere for the money to continue the vaccinations", but that was not the approach taken by IARC. I thought that was really an amazingly good thing to do.

– Bruce Armstrong, former IARC Deputy Director

THE IARC ETHICS COMMITTEE

The IARC Ethics Committee was established in 1982. It has two specific tasks: first, to verify that research projects in which IARC participates and that involve human subjects have received clearance by the relevant ethical committees at the country level, and second, to assess whether it is ethically appropriate for the Agency, in the light of its research mission and public health role within the framework of the World Health Organization, to participate in such projects. Projects must receive clearance from the IARC Ethics Committee before they begin. Any subsequent modifications of the study protocol must also be submitted to the committee for ethical clearance. Currently, the committee is composed of researchers and laypeople. A majority of its members, including the chair and vice-chair, are from outside the Agency.



Members of the IARC Ethics Committee at a recent meeting.

The crucial methodological innovation was to choose at random – rather than by convenience or in a systematic way – the newborns to be vaccinated each year. Actually, clusters of newborns (i.e. local vaccination teams), rather than individual newborns, were chosen at random. During the first year of the programme (1986), about 25% of all newborns, coming from areas covered by four vaccination teams chosen at random from a total of 17 countrywide, were vaccinated (to be compared with the 75% who were unvaccinated). During the second year, 50% were vaccinated. During the third year, 75% were vaccinated, and finally during the fourth year, all newborns were vaccinated. This design made possible an unbiased comparison between the randomly chosen vaccinated and unvaccinated subjects within each of the first three years of the programme. The random choice of newborns to be vaccinated was ethically unobjectionable since it was non-discriminatory and impartial.

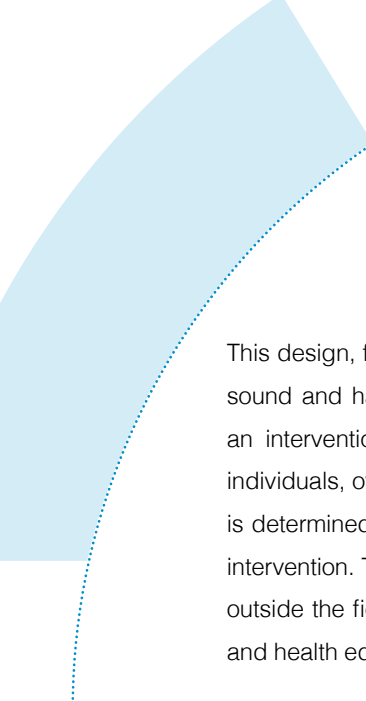

This design, first implemented in the Gambia Hepatitis Intervention Study, is both scientifically and ethically sound and has entered standard methodology as the “stepped-wedge” trial design. The principle is that an intervention is assigned sequentially to the trial participants, either as individuals or as clusters of individuals, over several time periods. Which individuals or clusters receive the intervention in each time slot is determined at random, and by the end of the random allocation all individuals or groups will receive the intervention. This type of design has been used, and continues to be used, in a variety of studies within and outside the field of cancer research, particularly in the evaluation of the effects of vaccinations, screening, and health education programmes.

ANALYSING MULTICENTRE EPIDEMIOLOGICAL STUDIES – A KEY IARC ACTIVITY

Breslow and Day’s synthesis consolidated a methodological basis that could be used as a standard starting point for a great variety of specific developments. At IARC, research in statistical methods has become more specialized over the ensuing decades and is now embedded within the different types of epidemiological studies. However, some areas of work maintain a more general perspective. One example is a recent paper from IARC, “Penalized loss functions for Bayesian model comparison”. Although the title sounds highly esoteric, in fact this research addresses the very general and fundamental issue of how to choose the best model in the analysis of any data set (e.g. how best to formalize the mathematical relationship between intake of various foods and the occurrence of colon cancer).

A second topic of broad relevance is the analysis of data from multicentre epidemiological studies. Conducting investigations in multiple populations was inherent to the scientific rationale for the establishment of IARC, particularly because in the mid-1960s this type of study was not common in cancer research. For example, multiple populations may be those in different geographical areas, chosen because they may have widely different lifestyle habits. Or multiple populations of workers exposed to the same potential cancer hazard (e.g. a chemical) at various factories may be chosen to achieve a total population large enough to attain a high sensitivity for detecting an increase in risk if it exists. Another advantage of multicentre studies is the possibility of verifying whether the results obtained within the different populations are consistent with each other. For example, finding the same inverse relationship between the intake of vegetable fibre and the frequency of colon cancer in different populations would be strong evidence in favour of a causal preventive role of vegetable fibre intake. In science, replicability, or at least consistency, of results – as is feasible in multicentre studies – is the most stringent criterion for judging causality. The methods for assessing consistency, although simple in principle, are fraught with complexities in practice (see “Combining epidemiological results from multiple populations”). Optimizing these methods is a continuous area of research in biostatistics at IARC.

COMBINING EPIDEMIOLOGICAL RESULTS FROM MULTIPLE POPULATIONS

Two basic types of comparison are possible when investigating factors that possibly cause cancer. The first is a comparison between individuals, measuring for each person the level of exposure to the factor of interest (e.g. daily meat consumption). The second is a comparison between large groups of people, typically the populations of a region or a country, estimating for each population the average level of exposure (e.g. average meat consumption). This second type of comparison has often been used in studies of the role of diet in cancer because it exploits the large variations in intake of different foods and nutrients that spontaneously occur between populations with vastly different cultural and dietary habits.

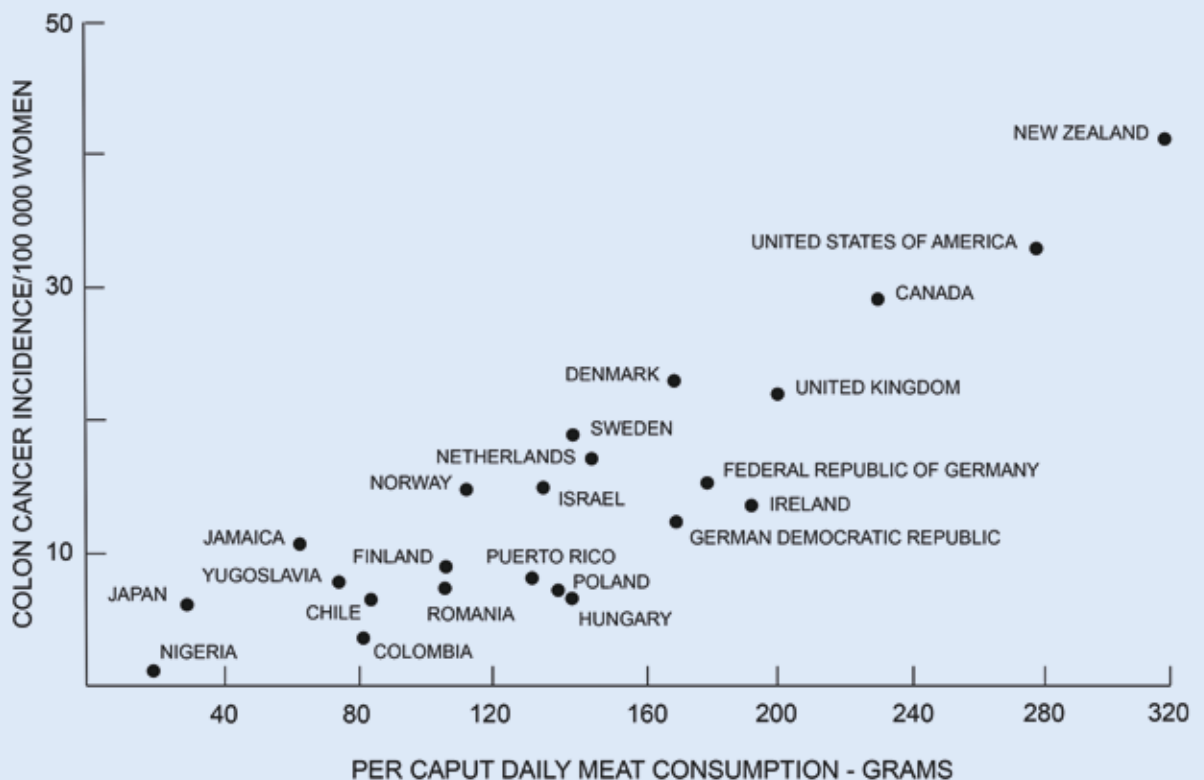

A clear relationship is seen between the average daily meat consumption (in grams per day) by women in a country and the incidence rate of colon cancer in women in the same country (in 1975): the higher the consumption, the higher the rate.

As shown in the graph, when the frequency (incidence rate) of colon cancer is plotted against the average daily meat consumption for women in different countries, a striking relationship emerges of increasing incidence rates with increasing dietary meat consumption. Does this speak in favour of meat consumption as a cause of colon cancer? It does, but there are a multitude of differences between the populations of women in different countries, other than just meat consumption. Therefore, one cannot be sure that the relationship seen in the graph is not produced by one or more of these other factors, known or unknown.

The relationship seen in the graph, termed “ecological” because it involves whole populations in different environments (countries), can only be regarded as suggestive. It needs to be confirmed by studies carried out at the level of individuals, termed “analytical” studies, which offer much better possibilities of measuring consumption for each person and ruling out factors other than meat consumption. Multicentre international studies – the type of epidemiological investigation in which IARC has developed unique expertise – combine the advantages of both approaches, ecological and analytical, and make it possible to check the consistency of the results obtained at the two levels.

If consistency holds, a picture closely similar to the one in the graph would be obtained within every country (or, more generally, for every study centre). The points on the graph would represent not countries but a group of women who are comparable in all characteristics but with different meat consumptions, measured individually. (Data for men would need to be looked at in the same way.) However, assessing whether a “close similarity” exists requires sophisticated statistical methods, incorporating the treatment of possible – and, in reality, inevitable – errors in measuring exposures like meat consumption. If the results pass the tests of consistency and show the same relationship between colon cancer occurrence and meat consumption within each country and for all countries combined, then the conclusion that meat consumption is a cause of colon cancer would be strongly supported. Methods that combine in a single analysis “within-centre” results and “between-centre” results are acquiring wide relevance in epidemiology, as reflected in the concluding sentence of an IARC paper developing this approach: “The use of multilevel models, which constitute a very powerful approach to estimating individual vs aggregate levels of evidence, should be considered in multicentre studies.”





CANCER REGISTRIES: A WORLDWIDE ENDEAVOUR

CANCER REGISTRIES: A WORLDWIDE ENDEAVOUR

Cancer occurrence has been documented for centuries by clinical and autopsy reports, and at the population level by data on causes of death. As Johannes Clemmesen, the founder of the first nationwide cancer registry, in Denmark, put it, “Favoured by its accessibility, and consequently by good conditions for diagnosis, mammary carcinoma was among the first neoplasms subject to valid statistical observation.” Clemmesen produced a very interesting comparison of the frequency of new cases of cancers of the breast and uterine cervix in Copenhagen, Denmark, in 1943–1957 with the frequency of deaths from the same two cancers as recorded by the city medical officer in Verona, Italy, in 1760–1839, the first known example of a proper statistical treatment of cancer data. The frequency in Verona was much higher than that in Denmark (perhaps due in part to an underestimate of the population), but the shapes of the two sets of curves show some interesting similarities.

In general, one would expect that cancer incidence rates and cancer mortality rates would be almost the same if cancer leads almost invariably to death, as was unfortunately the case until the middle of the 20th century. However, as effective treatments are introduced, mortality rates no longer reflect the incidence rates, and complete registration of new cases becomes indispensable to obtain a clear picture of the cancer burden in a population. Indeed, the development of cancer registration roughly paralleled the first tangible, although uneven, successes of cancer therapy – surgical, radiological, and drug treatments.

Mortality rates (per 10 000 women per year) for cancers of the breast and uterine cervix in Verona, Italy, in 1760–1839 (upper curves), and incidence rates for the same two cancers in Copenhagen, Denmark, in 1943–1957 (lower curves), as a function of age.

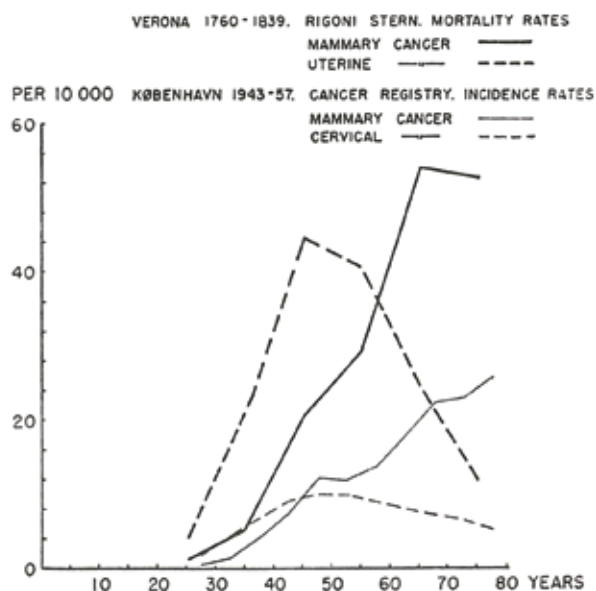



Participants in the Oxford meeting on the Geographical Pathology and Demography of Cancer, held on 29 July–5 August 1950. Johannes Clemmesen is in the back row, at the extreme right.

EARLY STEPS IN CANCER REGISTRATION, NATIONAL AND INTERNATIONAL

In Europe, the first register of cancers was established in Hamburg, Germany, as early as 1927, and similar regional initiatives were undertaken in the 1940s and 1950s in the United Kingdom and other countries. The nationwide registry in Denmark was instituted in 1942. In the USA, a series of surveys of cancer incidence were carried out in the late 1930s, and registration started in Connecticut and New York State in 1940.

Immediately after the Second World War, a group of European specialists interested in cancer statistics met in Copenhagen and recommended the implementation of cancer registration systems and the establishment of an international body to foster uniformity in terminology and classification as well as the correlation of the data obtained in each country. Based on this recommendation, in 1950 the World Health Organization (WHO) set up a subcommittee on the registration of cases of cancer as well as their statistical presentation. Clearly, the

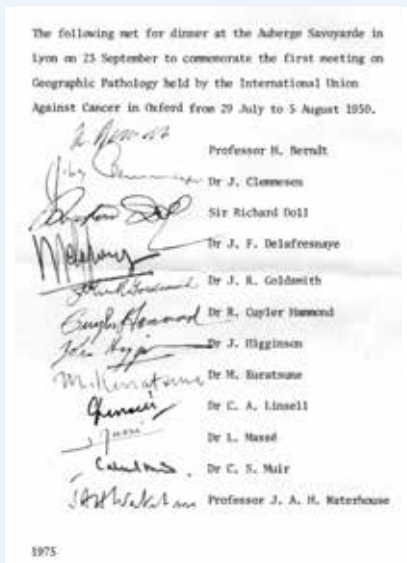

Signatures of some of the participants in the 1950 Oxford symposium, who met at IARC in September 1975 and convivially celebrated the Oxford event with a dinner at a nearby restaurant, the Auberge Savoyarde.

time was ripe for such initiatives: in the same year, UICC organized a week-long symposium in Oxford dedicated to the geographical pathology and demography of cancer. The Oxford gathering led to subsequent meetings on this topic, and to the establishment of an ad hoc committee that in 1966 produced a technical report, the first volume of the *Cancer Incidence in Five Continents* series (see “*Cancer Incidence in Five Continents, Volume I*”).

CANCER INCIDENCE IN FIVE CONTINENTS, VOLUME I

Richard Doll, Peter Payne, and John Waterhouse were responsible for the first compilation of international statistics on the incidence of cancer, published in 1966 under the aegis of UICC. This extract from the preface to Volume I of *Cancer Incidence in Five Continents* by the three editors gives an insight into the background, state of the art, and collaborative climate of the day.

“The suggestion that cancer incidence rates for different parts of the world should be brought together in a single volume arose in discussion among members of the Geographical Pathology Committee of the International Union Against Cancer during a symposium in Mexico in 1964. [Note: Another topic discussed at that meeting was the “French proposal” for a new cancer organization, highlighted in the chapter “The birth of IARC”.] That there was a need for such a volume rapidly became apparent when the directors of cancer registries were asked for their opinion. Of those approached, all but one responded enthusiastically and immediately agreed to contribute. In the event, data have been collected from 32 cancer registries in 24 countries, and 39 scientists have contributed personally by describing the character of their registry and by collecting and submitting figures in a standard way.

“The form in which the book appears was suggested by a committee of 15 members, which met at the Ciba Foundation in London in May 1965, and the editors have been guided in their work by the results of the discussions that took place at that meeting. In a few instances, it has not been possible to follow the Committee’s advice, for reasons of finance, and the text which was written by the editors may, in some places, have inadvertently misrepresented the Committee’s views. The editors, therefore, take full personal responsibility for all defects in both style and scientific presentation.

“It is a pleasure to acknowledge the help that has been given in the collection of information about individual registries by the Cancer Unit of the World Health Organization, and particularly by Dr A. Tuyns, who took part in the meeting of the Editorial Committee.”

CANCER REGISTRIES, AN ESSENTIAL TOOL FOR RESEARCH AND PUBLIC HEALTH

A cancer registry can be defined as an organization – with its own premises, resources, and personnel – for the systematic collection, storage, analysis, interpretation, and reporting of data on people with cancer.

Hospital-based cancer registries are concerned with the recording of information on the cancer patients seen in a particular hospital. Their main purpose is to contribute to patient care by providing readily accessible information on the patients with cancer, the treatment they received, and the outcome of the treatment. The data are used mainly for administrative purposes and for reviewing clinical performance.

Population-based cancer registries seek to collect data on all new cases of cancer occurring in a well-defined population. Their main objective is to produce statistics on the occurrence of cancer in a defined population and to provide a framework for assessing and controlling the impact of cancer in the community. A population-based cancer registry has at least three main uses.

The first is to describe the extent and nature of the cancer burden in the community and to assist in establishing public health priorities. These include preventive measures to reduce the observed burden of new cases as well as the provision of adequate health services, general and specialized, for the care of the expected number of cases.

The second main use is to be a source of material for epidemiological investigations of the causes of cancers – a necessary step for prevention. Registered cancers can be the cases in case-control studies (e.g. a comparison of the dietary habits of stomach cancer cases and controls), or a registry can be used to follow up a cohort of people (e.g. recording the lung cancer incidence in workers exposed to an airborne pollutant).

The third main use of a population-based cancer registry is to assist in monitoring and assessing the effectiveness of cancer control activities, in particular by examining area-based survival of treated cancer patients. Unlike hospital-based statistics, which are strongly influenced by the type and degree of severity of the cancer cases a hospital deals with, the area-based survival statistics provide an unbiased picture of the actual survival of all patients in a population as a result of the operation of the totality of the locally available health services.

IARC AND CANCER REGISTRIES AROUND THE WORLD

One might argue that the international variation in types and frequencies of cancers was the single observation that most defined the initial research focus of IARC. Certainly this emphasis was behind the creation in the late 1960s of IARC Regional Centres in populations where patterns of cancer were striking, such as in Singapore (see “Calum Muir”, and also the chapter “The birth of IARC”). A starting point for these centres was to establish reliable cancer registries. It was also not coincidental that John Higginson had been studying “geographical pathology” in Africa before being appointed as the first IARC Director, in 1966.



Calum Muir (foreground) discussing surveys of cancer occurrence around the world with Hrafn Tulinius, a pathologist and epidemiologist who worked at IARC from 1969 to 1975 before returning to his home country to become the director of the Icelandic Cancer Registry.

CALUM MUIR

Calum Muir joined IARC in 1966 as head of the Unit of Epidemiology. Aged 37, he had a sound background in human pathology, built up over more than a decade at the Department of Pathology of the University of Malaya (now the National University of Singapore). It was while in Singapore that Muir played an instrumental role in the creation of the IARC Regional Centre there, which started cancer registration in 1968. He had soon recognized the excellent opportunities to document and investigate differences in the incidence of disease among the various ethnic groups in Singapore, publishing several papers on heart disease and on a range of cancers. This line of research had convinced Muir of the essential importance of accurate registration of cancer cases, a task that became his first priority at IARC. He played an active role in the work leading to the publication of the first edition of the *International Classification of Diseases for Oncology* (ICD-O), in 1976, and he was an editor of the second edition, published in 1990.

As a pathologist, Muir did much to assemble the new morphological terms and the latest classifications for lymphomas, leukaemias, and brain tumours. He developed close contacts with cancer registries worldwide, through personal visits and meetings, and he was instrumental in founding the International Association of Cancer Registries in 1966, serving as deputy secretary from 1972 to 1990 and as president from 1992 until his death in 1995. (IARC has provided the secretariat for this nongovernmental organization since 1974.) In many countries, IARC became known – and achieved renown – thanks to Muir's career-long efforts to expand the network of cancer registries and stimulate their engagement in epidemiological research. He contributed to this research himself, in particular with publications on the cancer patterns in different ethnic groups and migrant populations, on cancer trends, and on the proportion of cancers attributable to various causes. In the second half of the 1960s, IARC was a newborn institution, and Muir, an affable and kind person, will be remembered for contributing his critically needed competence and strength during the early years of epidemiology at IARC.

This focus on cancer registration was firmly established by the time the second volume of *Cancer Incidence in Five Continents* was published, in 1970. By then, IARC and UICC were jointly coordinating the project. IARC's commitment to this field has been guided by two purposes: promoting a high and uniform quality of existing registries, and helping to establish new registries in the many areas of the world where none yet exist. The efforts have been focused on several areas: classification of cancers, data collection procedures, quality control procedures, education and training of personnel, worldwide expansion of registries' coverage, and publication of international cancer incidence data. In addition, IARC conducts analyses of registry incidence data on a worldwide scale (see the chapter "Cancer patterns, trends, and burden").

Classification of cancers

As early as 1968, IARC was asked by WHO to make recommendations about the content and structure of the neoplasm chapter in the ninth revision of the *International Classification of Diseases, Injuries, and Causes of Death* (ICD-9). Ever since then, IARC has been the key responsible party in the continuous process of updating ICD. In 1976, this role led to the publication of the *International Classification of Diseases for Oncology* (ICD-O), an expanded offshoot of ICD for the purposes of cancer classification. ICD-O classifies each tumour based on four criteria: the site of origin (e.g. the lung), the microscopic appearance (histology) of the tumour, the degree of differentiation of the tumour (e.g. a lung cancer may have a poorly differentiated "squamous carcinoma" histology), and the biological behaviour (i.e. whether the tumour is biologically aggressive and malignant or is instead benign).

“*ICD-O is a very specific thing that IARC has been involved in right from the start with the first edition. That's been a great advantage to the cancer world, to have a classification of cancers in a uniform way, and it was very well used.*”
– Max Parkin, former IARC scientist

The third edition of ICD-O (ICD-O-3, published in 2000 and dedicated to Calum Muir) uses the nomenclature of the WHO Classification of Tumours series (the "Blue Books"; see the chapter "Education and training of cancer researchers"). As these classifications are revised and new histological terms are introduced, ICD-O-3 is updated with new or modified codes and terms; the first revision was published in 2013. ICD-O has been published in a wide range of languages, and conversions from one version of a classification system to the next, or from one system to another (e.g. from ICD-O to ICD), can often be performed using dedicated software.

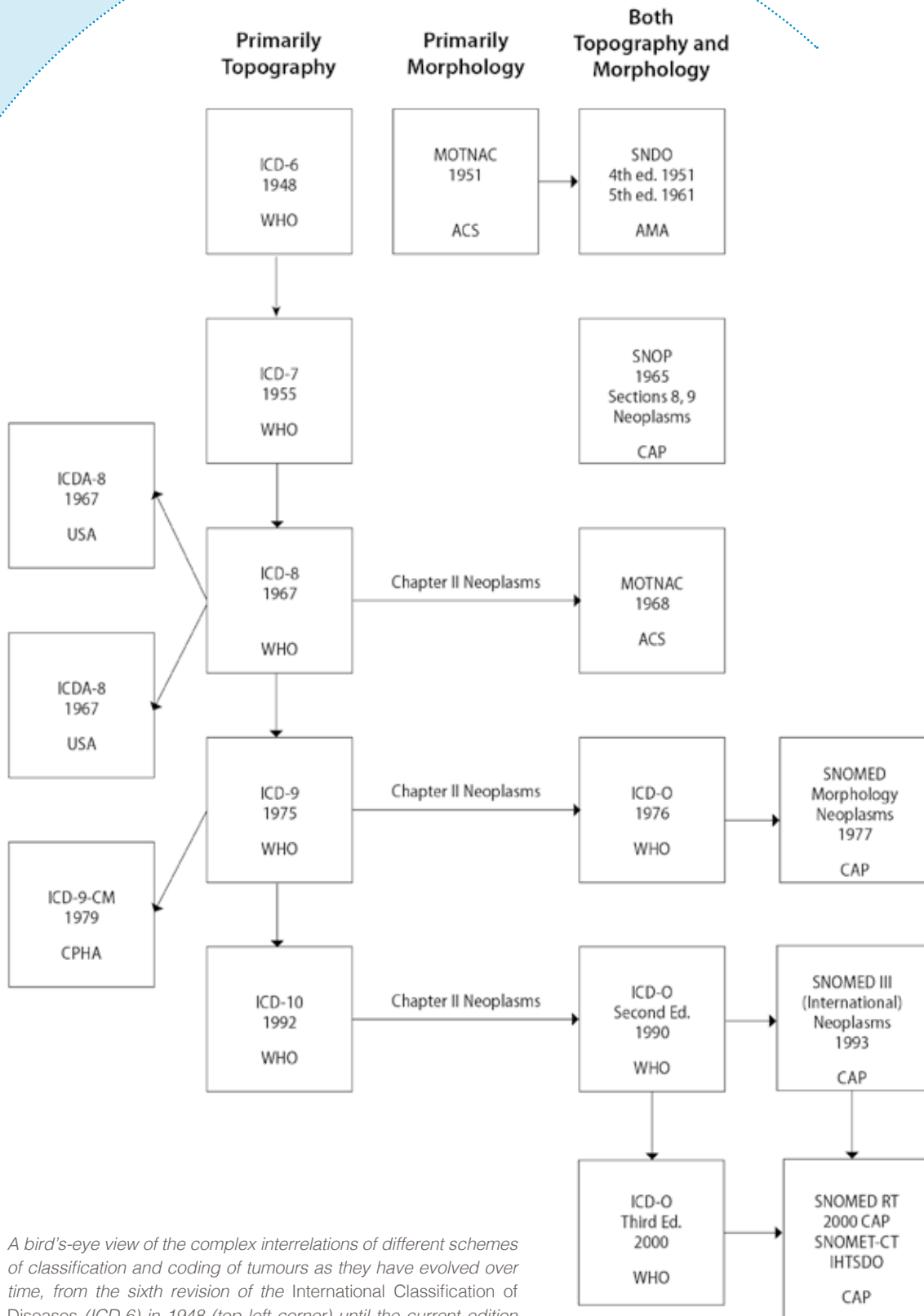

A bird's-eye view of the complex interrelations of different schemes of classification and coding of tumours as they have evolved over time, from the sixth revision of the International Classification of Diseases (ICD-6) in 1948 (top left corner) until the current edition of the International Classification of Diseases for Oncology (ICD-O) and the Systematized Nomenclature of Medicine (SNOMED) in 2000 (bottom right corner).

Data collection procedures

Cancer registries collect information from three main sources: hospitals, laboratory services, and death certificates. Computerized hospital information systems or manual indexes of hospital discharges are the primary sources of data on patients and their diagnoses. Private hospitals and clinics in the area covered by the registry should be included among the information sources, as should hospices and palliative care services. The second key source of information is pathology laboratories, which provide the definitive histological diagnosis of a tumour. The third source is death certificates. These documents are important because they enable the identification of cancer cases that may have been missed by the other two sources, and make it possible to investigate the survival of cancer patients.

Which information should a cancer registry abstract from the records of these sources? IARC provides guidance mainly through two books: *Cancer Registration: Principles and Methods*, published in 1991, and *Planning and Developing Population-Based Cancer Registration in Low- and Middle-Income Settings*, published in 2014. Both publications contain relevant references to practical tools for cancer registration, in particular software packages for data processing and storage. The *minimum set of information* that should be reported by a registry includes data identifying the person and the key characteristics of the tumour.

Quality control procedures

Cancer registries are permanent structures, and population-based cancer registration is a continuous process. Built-in quality control procedures are necessary to ensure that the completeness and high quality of registry data are maintained over time. “Intelligent” computer terminals for data entry perform a series of automatic checks to ensure that inconsistent data are not accepted (in these cases, the registry refers back

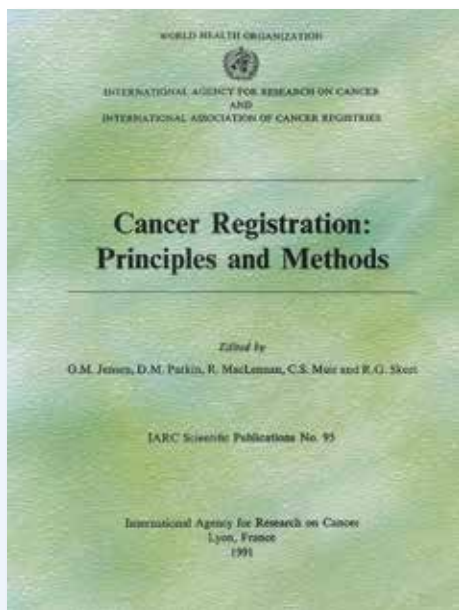



IARC was very important in trying to act as an international focus for cancer registries and in particular in setting standards, to try and make them similar worldwide so that the data are more or less comparable from one place to another.

– Max Parkin, former IARC scientist

to the data source for clarification and correction). An example of such an inconsistency is a reported date of tumour diagnosis that is earlier than the patient's date of birth.

Once the data have been accepted, a second series of checks on the overall information make it possible to verify the completeness and accuracy of the data collected. For example, a high percentage of cases

reported only when the person dies (i.e. via a death certificate) is indicative of poor quality of registration, whereas a high percentage of cases for which the diagnosis was based on microscopic verification of a tissue specimen is usually an indicator of good quality. Throughout the years, IARC has been instrumental in introducing and popularizing among registries data quality indicators, some of which have become criteria for inclusion of the incidence data from a registry in the publication *Cancer Incidence in Five Continents*.

Education and training of personnel

Since 1967, when the first IARC course on methods for cancer epidemiology was organized (see the chapter "Education and training of cancer researchers"), IARC has been deeply committed to the education and training of registry personnel, through courses and workshops, site visits by IARC scientists, and publications and software packages. Often, these activities have benefited from a close collaboration with the International Association of Cancer Registries.



The CanReg5 welcome window.

Although all IARC courses on epidemiological methods include the topic of cancer registration, about 50 courses, held in Lyon and at sites around the world, have been dedicated to cancer registration. Since 2005, the first module of the IARC Summer School in Cancer Epidemiology, held in Lyon each year, has been devoted to cancer registration. The teaching of this particular module is now being transferred to the newly established IARC Regional Hubs for Cancer Registration.

CanReg5 is one of the software packages developed by IARC for cancer registries. CanReg5 is an open-source tool specially designed to input, store, check, and analyse population-based cancer registry data. For registries using other software, a conversion program is available. CanReg5 is available in Chinese, English, French, Portuguese, Russian, and Spanish, with online help in English. Training sessions on CanReg5 are systematically included in IARC's cancer registration courses, which are presented face-to-face and, more recently, also in distance learning mode.

Worldwide expansion of registries' coverage

The expansion of the global network of cancer registries ranks high among IARC's achievements. Over the past 50 years, the number of registries and populations covered by registration has increased steadily, by a factor of 10. This success is an example of the rewards of the shared dedication and enthusiasm of very many participants, motivated by a common priority. This has been the case for the collaboration of individual registries (and often a single devoted



IARC is unique in the body of international epidemiological data it has on cancer incidence throughout five continents.
 – Bruce Armstrong, former IARC Deputy Director

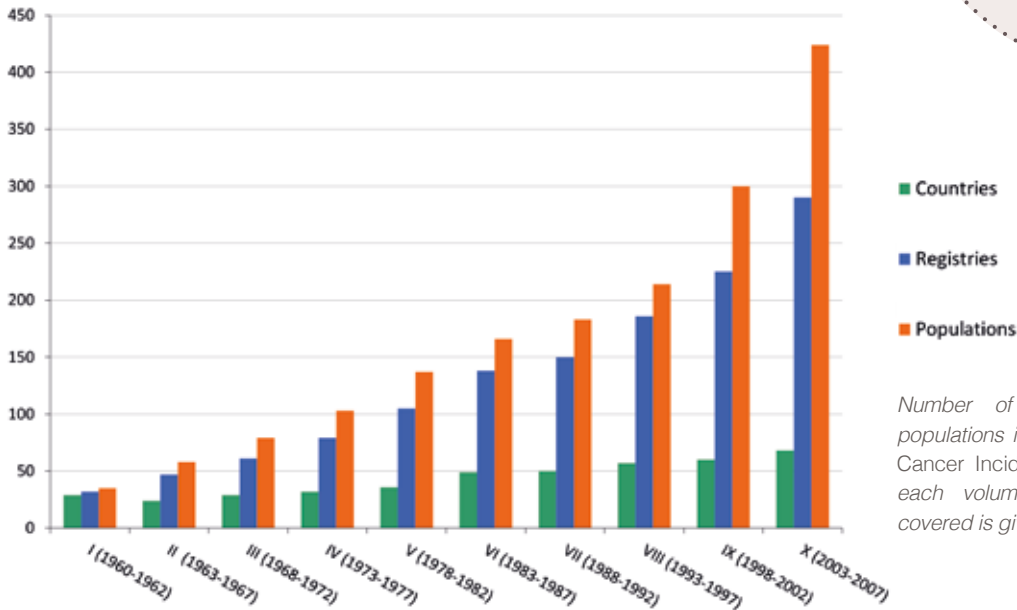

Number of countries, registries, and populations included in the 10 volumes of Cancer Incidence in Five Continents. For each volume, the approximate period covered is given.

person at a registry), and of the registries collectively through the International Association of Cancer Registries, with IARC. Regional activities have also furthered the expansion of registries; a good example is the GRELL Network (www.grell-network.org), created in 1975 at the initiative of IARC epidemiologist Albert Tuyns and Luc Raymond of the Geneva Cancer Registry.

A defining feature of IARC's approach to cancer registration has been, and continues to be, working directly alongside cancer registrars all over the world, assisting with the small practical details as well as the larger strategic issues. This has undoubtedly underpinned the willingness of registries to share their hard-won data with IARC and thus to permit the global picture of cancer occurrence to emerge.

Despite this remarkable progress, much remains to be done: only about 21% of the world's population is covered by population-based cancer registries, with particularly sparse registration coverage in Asia (8% of the total population) and in Africa (11%). Even within these underrepresented regions, there are further disparities, with rural areas far less well covered than urban areas. However, to put these figures,

Current global coverage and status of population-based cancer registration (PBCR), by extent (national or regional) and quality (high-quality vs simple registration or just some registration activity).

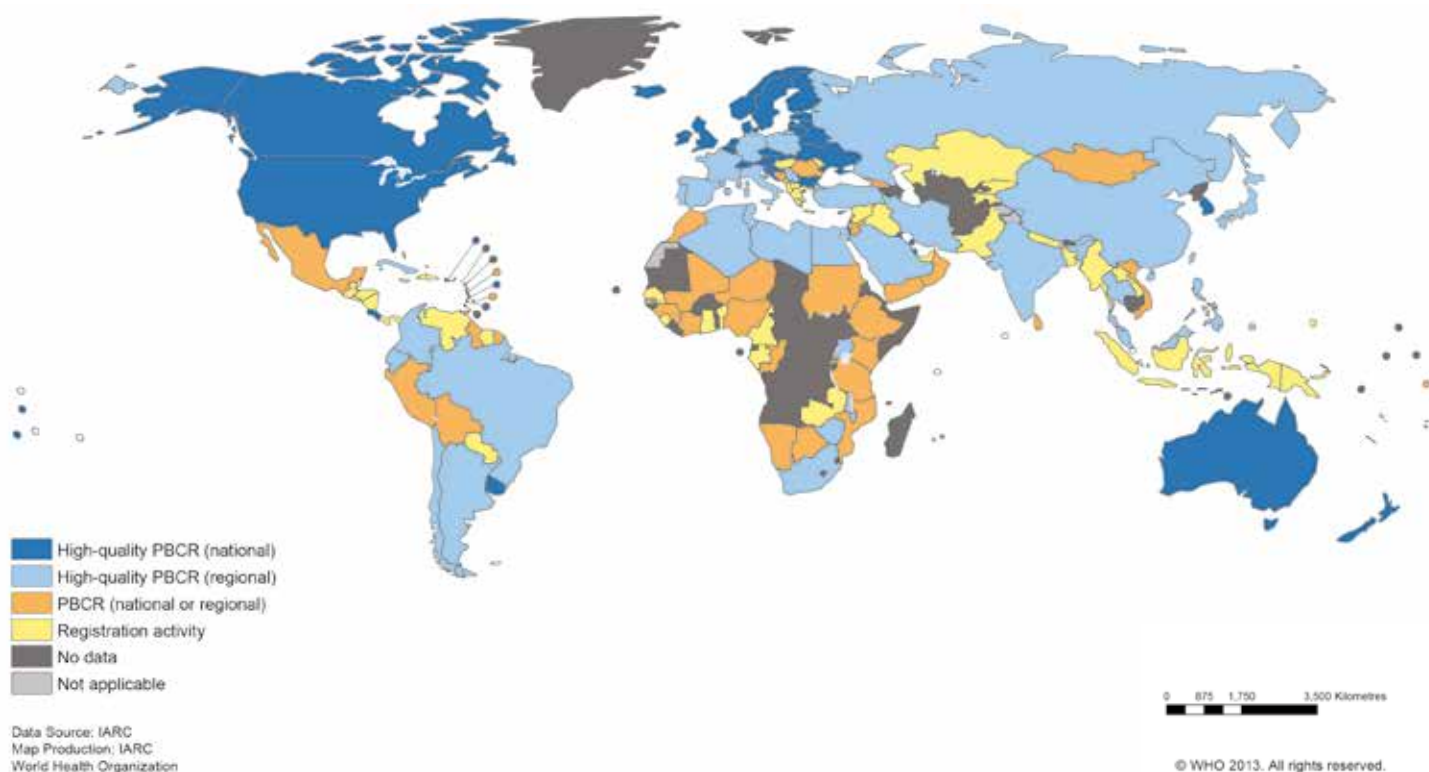

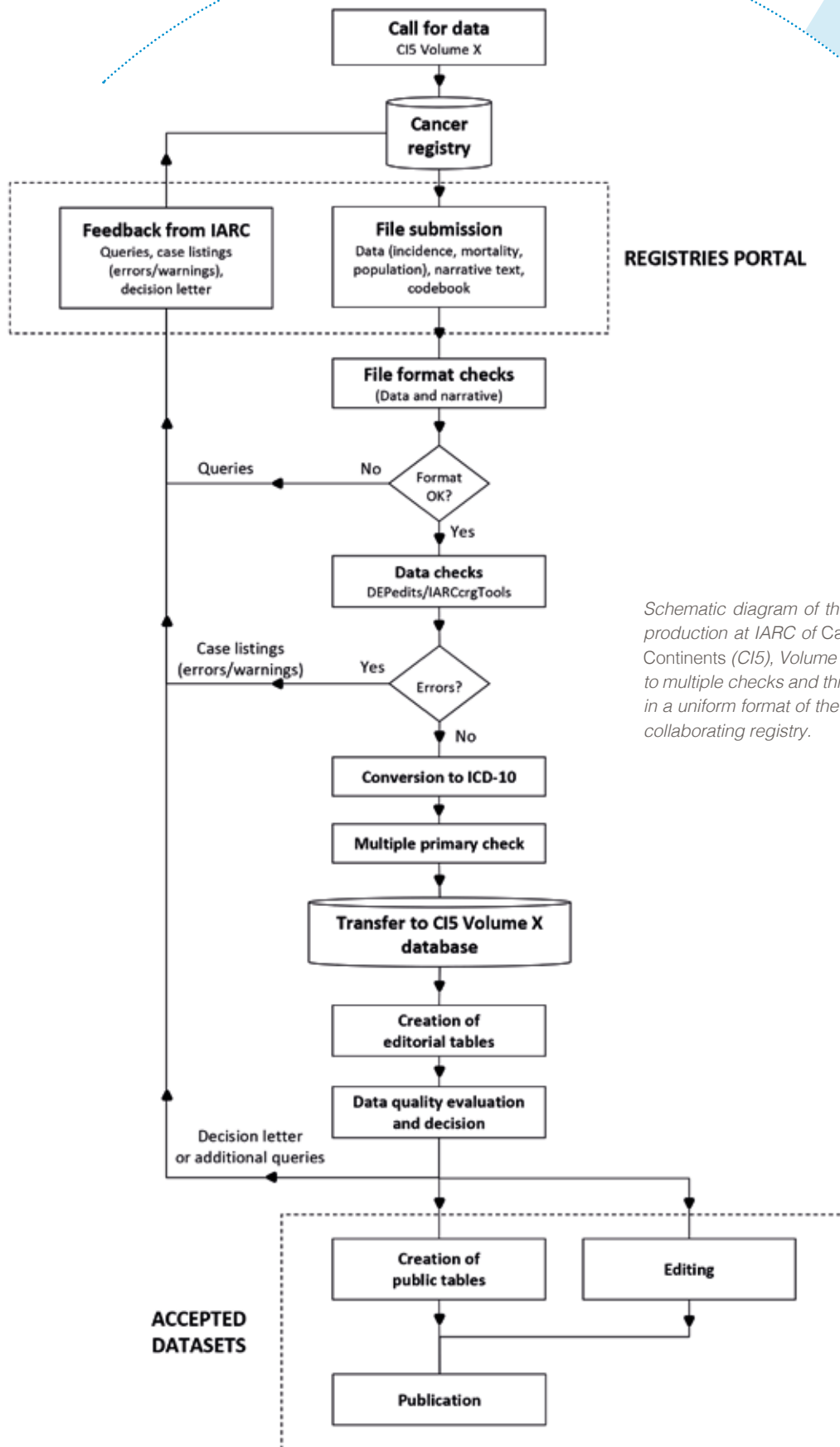

Schematic diagram of the steps involved in the production at IARC of Cancer Incidence in Five Continents (CI5), Volume X, from the call for data to multiple checks and through to the publication in a uniform format of the statistical data of each collaborating registry.

unsatisfactory as they are, into perspective, it is useful to remember that even for the certification of cause of death, a procedure that has a centuries-long history, only about one third of the world's population is adequately covered.

To further boost cancer registration, IARC has moved into a new era by establishing a series of IARC Regional Hubs for Cancer Registration in Africa, Asia, the Caribbean, Latin America, and the Pacific Islands. These Regional Hubs in liaison with IARC will develop specific tools in support of registries, including the assessment of registry quality, the publication and presentation of data, the coordination of research projects, and continental data analyses and reports based on all the registries in a Hub region. This approach of devolved responsibility for the development of cancer registries harnesses local expertise, supported by the international standards and expertise of IARC. The IARC Regional Hubs form part of the Global Initiative for Cancer Registry Development (gicr.iarc.fr), launched by IARC in 2011 to “make cancer data count” in driving national cancer control policies.

Publication of international cancer incidence data

The publication of the first volume of *Cancer Incidence in Five Continents* (or, as the series has become known, CI5; ci5.iarc.fr) has been followed by nine further volumes. Volume X reports incidence data for the period 2003–2007 from 290 registries in 68 countries. Even in this computerized era, the acquisition of data from every registry, the processing of the data, and the production for each main cancer type of standard tables subdivided by sex and age group is a complex job, involving several cycles of communication between IARC and registry professionals to verify the completeness and accuracy of the data. On average, the preparation of a volume of *Cancer Incidence in Five Continents* takes about three years.

Childhood cancers, usually defined as those occurring before the age of 15 years, are distinct entities from cancers in adults, and IARC has a special project (*International Incidence of Childhood Cancer*, iicc.iarc.fr) dedicated to the acquisition and dissemination of data on cancer incidence in children. Collected incidence data on childhood cancer were published as *International Incidence of Childhood Cancer* volumes in 1988 (IARC Scientific Publication No. 87) and in 1998 (IARC Scientific Publication No. 144); a third volume is in preparation. In addition, the book *Epidemiology of Childhood Cancer*, by Julian Little (IARC Scientific Publication No. 149) was published in 1999.

“
The production every five years or so of *Cancer Incidence in Five Continents* was a very important contribution that IARC made to mapping out the cancer spectrum across the world.
– Norman Breslow, former IARC scientist

You are here: [Home](#) / [About](#) / [Rationale](#)**ABOUT**

- [Rationale](#)
- [IICC-3 Highlights](#)
- [Editorial Board](#)
- [Previous Volumes](#)
- [References](#)

**ABOUT IICC-3****Rationale**

Cancers occurring in children are marked by low incidence rates, typical histologies, favourable survival in resource-rich countries, long-term survivorship issues and a range of ethical, psychological and societal concerns. These characteristics, combined with data presentation requirements unique to these cancers, make a strong case for oncologists and epidemiologists to study childhood cancers separately from other cancers.

As a part of its mission of collection and dissemination of data on cancer, IARC recognises the need for a specific approach to collecting and disseminating childhood cancer data. Following the publication of the two volumes of International Incidence of Childhood Cancer in 1988 (IICC-1) [10] and 1998 (IICC-2) [8], IARC is launching, in collaboration with IACR, the third monograph of the series. The new publication will fill the gap in the availability of international data on childhood cancer incidence, after the two previous volumes covering roughly the 1970s and 1980s, respectively.

CANCER PATTERNS, TRENDS, AND BURDEN

Earshi

Bhopal

Breast

Cervix

26

24

22

20

18

16

Breast

Cervix

1990

1995

2000

2005

1985

1990

1995

2000

2005

Delhi

Mumbai

Breast

30

25

20

15

10

Cervix

Breast

Cervix

1990

1995

2000

2005

1985

1990

1995

2000

2005

Calendar year

CANCER PATTERNS, TRENDS, AND BURDEN

Describing cancer occurrence and mortality in populations is a fundamental task of epidemiology and has been a feature of IARC's work since its birth. These descriptions serve three distinct and important purposes. First, variations in cancer occurrence between populations in different places, at different times, or with different characteristics can provide clues to the factors causing such variations (see the chapter "Cancer registries: a worldwide endeavour"). Consequently, descriptive epidemiology data often constitute the starting point in the search for cancer causes. Second, these data, particularly time trends in cancer occurrence and in survival of people with cancer, provide conclusive evidence with respect to the effectiveness of interventions against cancer. If research correctly identifies a cause and it is then removed, a documentable fall in cancer occurrence must ensue. Similarly, if a treatment is effective it should produce a net increase in survival. In this way, descriptive epidemiology data put the final seal on a cycle of research and interventions against a cancer. Third, descriptive epidemiology is the absolutely essential tool for describing the cancer burden in a population in quantitative form, and the indispensable premise for rational planning of cancer control actions and services.

CLUES TO CAUSES

Exploring cancer occurrence systematically

Since its first volumes, *Cancer Incidence in Five Continents* has presented in a uniform way cancer incidence rates by age and sex for each cancer registry. In addition, tables are included of incidence rates, standardized by age to a common "world population" age structure, for each registry and each major type of cancer. These tables are a simple but valuable form of registry data analysis, enabling cancer occurrence in different geographical areas to be compared.

“
There was something completely incomprehensible: cancers of the upper aerodigestive tract were extremely common in southern Europe but rare in northern Europe while, conversely, lung cancer incidence was very high in the north and less so in the south. We conducted a large study, which showed the importance of alcohol consumption for cancer of the larynx in southern Europe. Certainly, the development of epidemiology in the Latin countries of Europe was also greatly helped by conducting this study.

– Jacques Estève, former IARC scientist

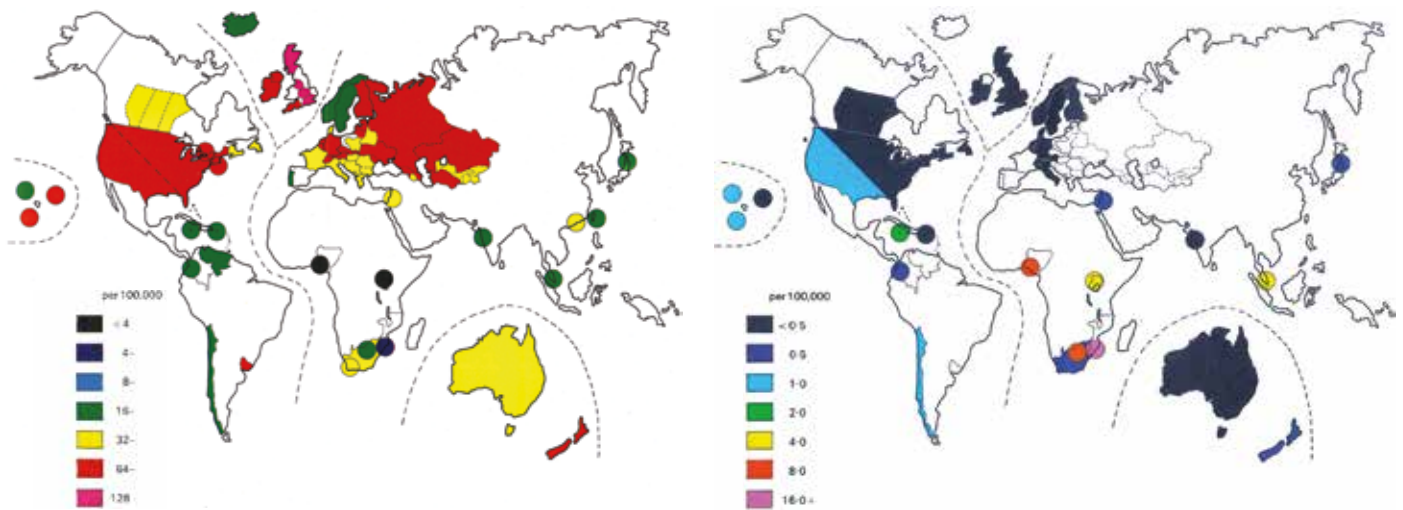

Maps of lung cancer incidence rates (left) and primary liver cancer incidence rates (right) in about 1965 (cases per 100 000 people per year). Some large areas were well covered by registries that provided incidence data; in other areas, only some localized registration existed (circles), and in others no data at all were available.

The information in the tables can be used to draw maps. The two maps shown here are from Richard Doll's 1967 book *Prevention of Cancer: Pointers from Epidemiology*. The first shows the geographical distribution of lung cancer incidence rates in about 1965. There are striking differences. The high rates in countries with industrialized lifestyles reflect chiefly the role of tobacco smoke and also the effect of urban air pollutants. When this map was produced, the causal role of tobacco smoking had already been established, but other maps raised questions. An example is the second one shown here. What were the causes of the variation in liver cancer incidence, with high rates recorded by registries in areas of Africa and Asia and low rates in industrialized countries? Agents in the environment were identified as obvious initial suspects, leading to IARC's research projects on aflatoxins (see the chapter "Carcinogens in the human environment") and hepatitis viruses (see the chapter "Viruses and vaccines"). The Agency used a similar approach in relation to variations in cancers of the lung and larynx across Europe, helping to establish the important role of alcohol in the case of cancer of the larynx.

Over the decades, IARC has supported the systematic development of cancer registries throughout the world, in cooperation with the International Association of Cancer Registries (see the chapter "Cancer registries: a worldwide endeavour"). This has enabled the scope of cancer incidence analyses to expand in three directions: (i) a more complete coverage of countries, for many of which no data had been available in the first rounds of the exercise; (ii) more reliable estimates of incidence rates based on larger numbers of cancers recorded, a feature of special importance for the less frequent types of malignancies; and (iii) the possibility of observing, for the first time, trends in cancer incidence in the medium and long term, over periods of up to several decades.

IARC was swift in supporting and developing these opportunities for data analyses on a global scale, as evidenced by two books, published in 1990 and in 1993. *Patterns of Cancer in Five Continents* (IARC Scientific Publication No. 102) summarizes in graphical format, for easy comparability, the incidence data collected in *Cancer Incidence in Five Continents*, Volume V (mostly recorded between 1978 and 1982). *Trends in Cancer Incidence and Mortality* (IARC Scientific Publication No. 121) is the first comprehensive analysis of changes in cancer incidence and mortality around the world over a 30-year period. For cancer incidence, the analyses covered 60 populations in 29 countries.

As Max Parkin remarked, not only were increasingly reliable data flowing in to IARC from registries all over the world; the evolution of computerized data processing was also making faster, more flexible, and more complete analyses feasible (see “Global cancer surveillance: a job for IARC”). The latest product of this evolution is the GLOBOCAN 2012 database (globocan.iarc.fr), which contains incidence, mortality, and prevalence estimates for 27 site-specific cancers and for all sites combined in 184 countries worldwide. Building on earlier versions in 2002 and 2008, GLOBOCAN 2012 provides users with access to information on the data sources and reliability as well as summary statistics for each country. An “Online Analysis” option enables the production of more detailed tables and graphs as well as projections of cancer burden over the next two decades.

Current questions and clues

The data in successive volumes of *Cancer Incidence in Five Continents* can be used to derive graphs showing the time trends in cancer incidence and mortality rates over decades. These data are readily available in the “Online Analysis” facility of the *CI5plus* website (ci5.iarc.fr/CI5plus). The simultaneous comparison of incidence and mortality in different populations and over time, using the data of *Cancer Incidence in Five Continents*, can generate both questions and clues as to the factors producing the observed patterns.

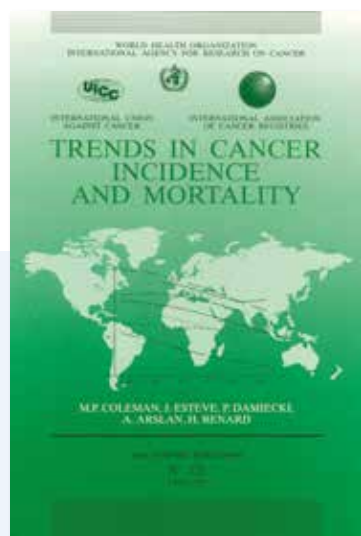
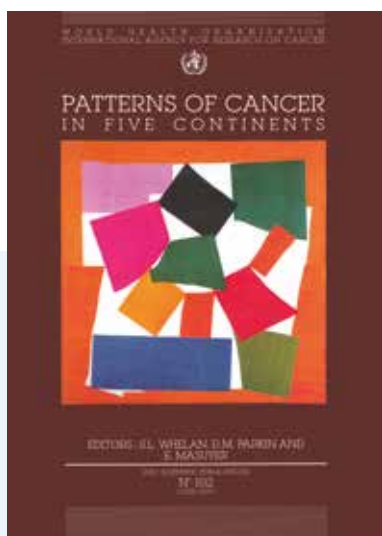

GLOBAL CANCER SURVEILLANCE: A JOB FOR IARC

Max Parkin worked at IARC from 1981 to 2004, and for almost 20 years he was the head of descriptive epidemiology research. Within this broader activity, his commitment ensured the production at regular intervals of up-to-date and reliable estimates of cancer occurrence around the world. These IARC estimates have become the standard reference internationally and are today available online in the user-friendly form of GLOBOCAN. Parkin recalls working at IARC in the 1980s.

“In the Descriptive Epidemiology Unit, we were concerned primarily with exactly the same mission as the Cancer Surveillance Section today. We were looking at cancer occurrence around the world. It is difficult to look back now: there was no Internet, no rapid communication when I came in the 1980s. Of course we had computers, but it was all mainframe computers at that time. The Agency had a central computer with terminals in one room. That is how it worked. Everything was produced from the paper records coming in; it was obviously a slow and hard process.

“However, working at IARC represented a great benefit in getting international collaborations. IARC was regarded as a trusted partner, which was not going to abuse its role of coordinator in having access to scientific data from individual partners around the world. So that was a huge advantage that would have been very difficult to replicate for any other institution.”



Max Parkin headed the descriptive epidemiology activities at IARC for many years and initiated the first global estimates of cancer burden.

The “Online Analysis” option in the GLOBOCAN 2012 database.



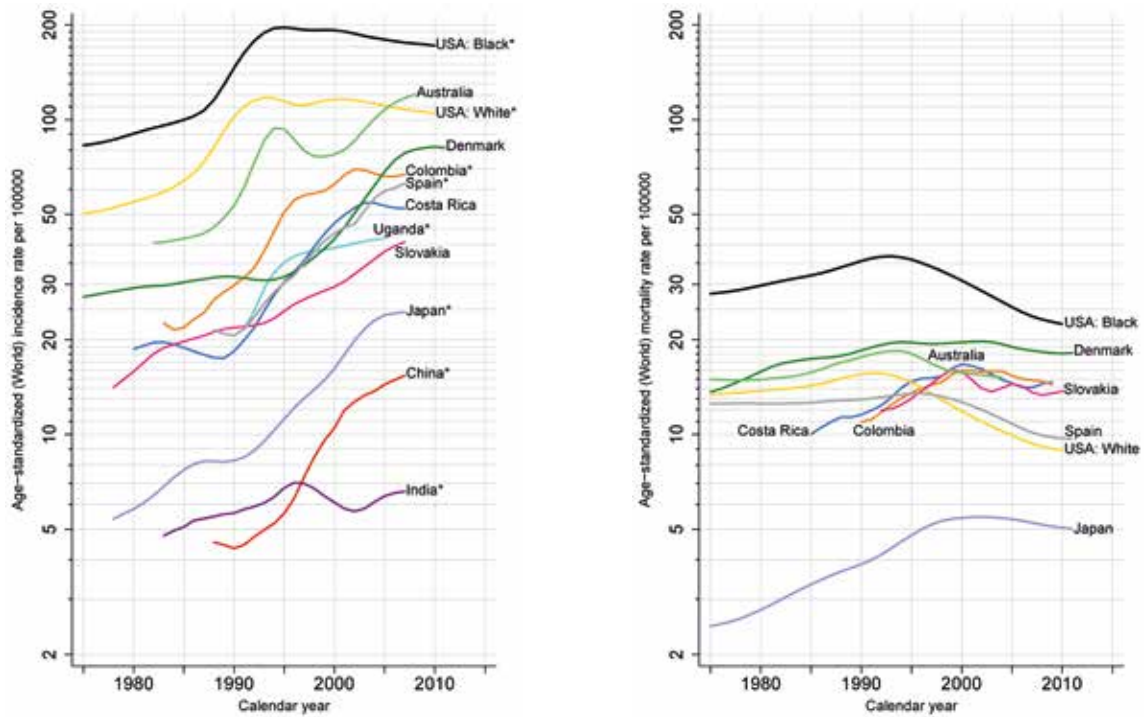

Prostate cancer incidence rates (left; cases per 100 000 men per year) and mortality rates (right; deaths per 100 000 men per year) in selected populations, age-standardized to a common world population.

An example is prostate cancer. The graphs derived from CI5plus data display the comparison of incidence and mortality rates for prostate cancer among 12 populations over a 30-year period. Prostate cancer is the second most frequently diagnosed cancer among men worldwide, and its incidence varies more than 25-fold between the high values of the USA and Australia and the low value of India. Rates of newly diagnosed cases increased rapidly in the late 1980s in North America as the prostate-specific antigen (PSA) screening test was introduced, and a similar pattern arose in many of the highest-resource countries during the 1990s. In contrast, prostate cancer mortality rates underwent little change or tended towards a modest decline.

Does the combined evidence of markedly rising incidence and steady or diminishing mortality indicate that spectacular advances have occurred in treatment? Or is it the case that PSA testing has increased the detection of all prostate cancers, including indolent ones that would never have progressed and caused the patient's death? The answer is still the subject of investigation, but it appears that the evidence leans mostly towards the PSA test detecting a substantial proportion of indolent cancers, with a search continuing for improved markers to better distinguish these cancers from the aggressive ones. In turn, the question remains open as to whether part of the observed increase in incidence may be due to factors other than enhanced detection of cases – for instance, as a result of affluent lifestyles in the countries most affected.

Cancer in migrants

Among the many populations that can be studied, those of migrants are of special interest. Studies of cancer in migrant populations permit comparisons of cancer incidence in populations of similar genetic background living in different environments. Differences in incidence between the migrant population and the population of origin point to the influences of environmental factors to which migrants are exposed in the host country.

“ The most significant achievement of the Agency is the description of the variation in cancer rates between different populations and over time. That description of the geography of cancer changed the way in which people think about the avoidability of cancer. IARC has done an enormous service over the decades in its descriptive statistics from different parts of the world. – Richard Peto, long-term IARC collaborator

IARC epidemiologists have participated in analyses of cancer mortality in various migrant populations. Examples include Polish-born migrants to England and Wales as well as North African migrants to France. More systematic work has been collated in two IARC publications, one on Jewish people migrating to Israel from many countries (see “*Cancer Incidence in Jewish Migrants to Israel 1961–1981*”) and the other on Italian migrants to various countries. From both, the trend clearly emerges of an increasing incidence of cancers like those of the lung, colon and rectum, and female breast with migration to environments with prevailing lifestyle habits typical of industrialized countries.

Inequalities within a population with regard to cancer incidence and survival can also be observed from cancer registry information. A good example of this is a recent set of IARC studies of indigenous peoples of North America and Australasia. These show higher incidence rates among the indigenous peoples of some cancers associated with industrialized lifestyles, for example lung cancer linked to smoking, but also of infection-related cancers such as cervical and liver cancers. In a further example, trends in breast cancer incidence (increasing) and cervical cancer incidence (decreasing) in India demonstrate the changing patterns with improving human development, and how this transition lags behind in rural areas (e.g. Barshi) compared with urban areas (e.g. Delhi). These within-country comparisons can provide policy-makers with important indicators as to where additional emphasis needs to be placed on cancer control measures to serve more vulnerable, and often disadvantaged, sectors of society.

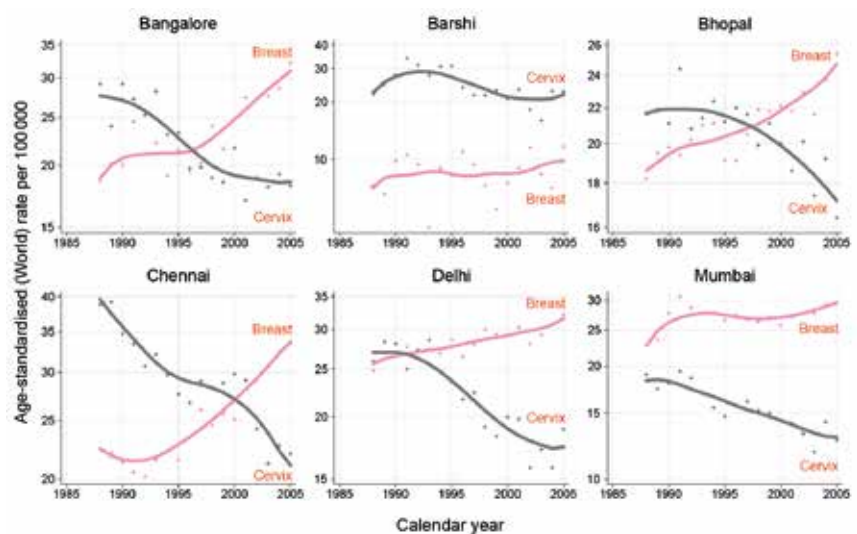

Trends in cervical and breast cancer incidence rates in six cancer registration areas in India. The Barshi area remains mostly rural and exhibits only minor variations in rates, whereas in the other five areas socioeconomic transitions have been accompanied by marked changes in cancer incidence rates, particularly a major decrease in cervical cancer occurrence.

CANCER INCIDENCE IN JEWISH MIGRANTS TO ISRAEL 1961–1981

IARC Scientific Publication No. 98, *Cancer Incidence in Jewish Migrants to Israel 1961–1981*, was published in 1989. It used the database of the Israel Cancer Registry (active since 1960) to compute age-standardized cancer incidence rates for 13 Jewish migrant populations as well as the population of Jews born in Israel. For comparison purposes, rates from cancer registries in the country of origin of the migrants were derived from data in *Cancer Incidence in Five Continents*, Volume III. Results were presented in the form of tables and graphs.

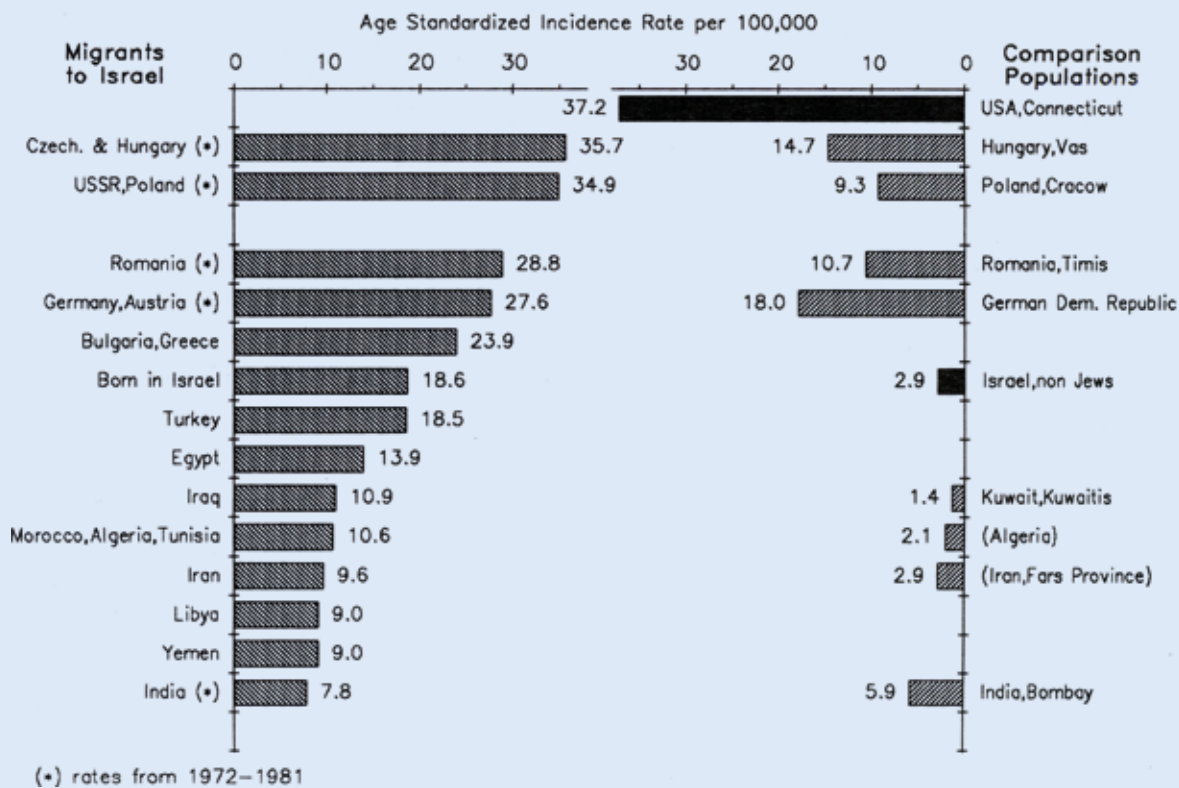

The bars in the first figure indicate the rates of cancer of the colon and rectum for female migrants to Israel (bars at left) and for the population of the corresponding country of origin (bars at right; at the top is shown the highest recorded rate, for USA, Connecticut). A pattern is evident of increasing incidence as people migrated from less-developed countries to Israel, where lifestyle habits – including diets – more typical of industrialized countries were adopted. The pattern for male migrants was closely similar.

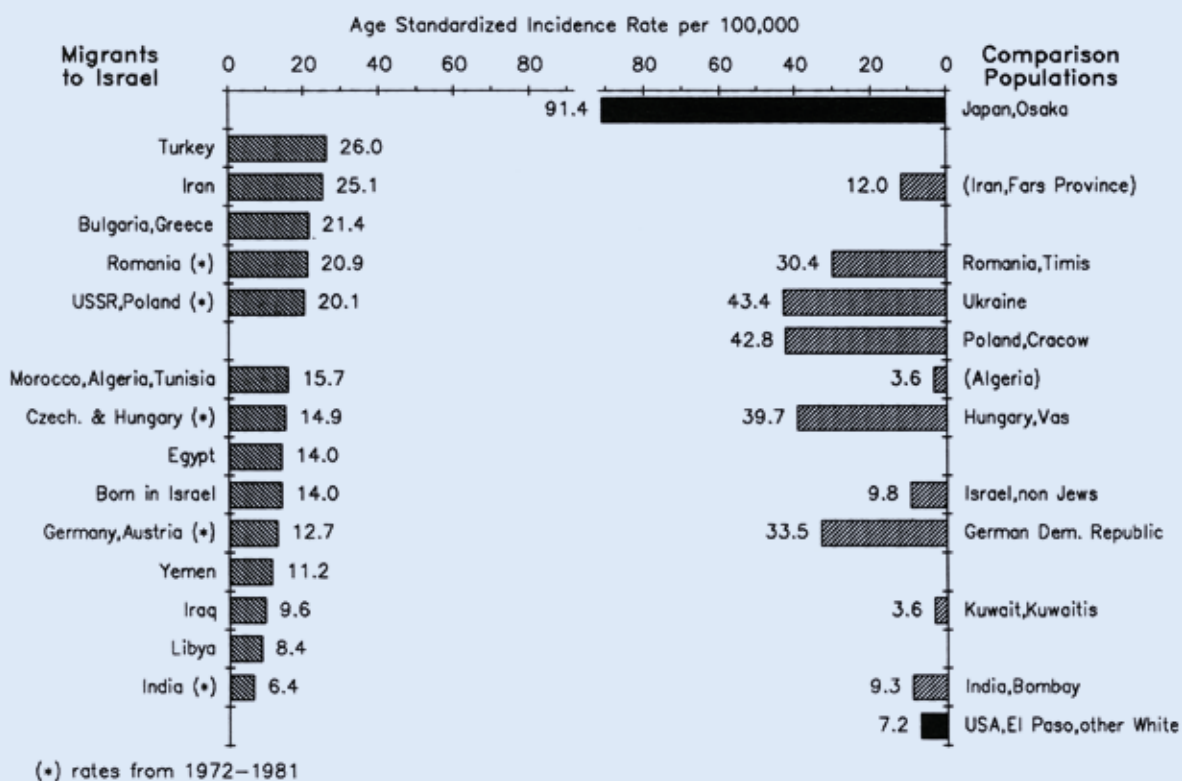

The second figure shows the rates of stomach cancer for male migrants to Israel. Here, a picture appears that is reversed with respect to that for cancers of the colon and rectum (and the pattern for female migrants was the same). Higher rates occur in the less-developed country of origin (at right) than among the migrants to Israel (at left). This points to environmental factors in Israel that are less conducive to the development of stomach cancer or have a more protective effect.

CANCER CONTROL IS EFFECTIVE

Appropriately designed studies are usually carried out to test whether a preventive intervention against cancer or a therapeutic treatment in patients actually works. If this is the case and the intervention or treatment becomes generalized on a large scale, its positive effect should be visible in the decline of the incidence of the cancer in the whole population or in an improved outlook for patients.

The best example of an effective preventive intervention is the campaign against smallpox, the first disease to have been fought on a global scale. After the World Health Organization (WHO) introduced the Smallpox Eradication Programme in 1966, the number of recorded cases – still sizeable in the late 1960s in some parts of Africa – progressively declined to zero. Smallpox was officially declared eradicated throughout the world in 1980.

Trends in cancer incidence

Statistics from cancer registries are a key instrument to demonstrate the effectiveness of preventive interventions. For example, as shown schematically in the figure, they can be used to monitor in various countries the stages of the epidemic of lung cancer and other tobacco-related diseases as a result of the increase in the prevalence of tobacco smoking in the country and, later, the decrease in prevalence, due to effective preventive interventions.

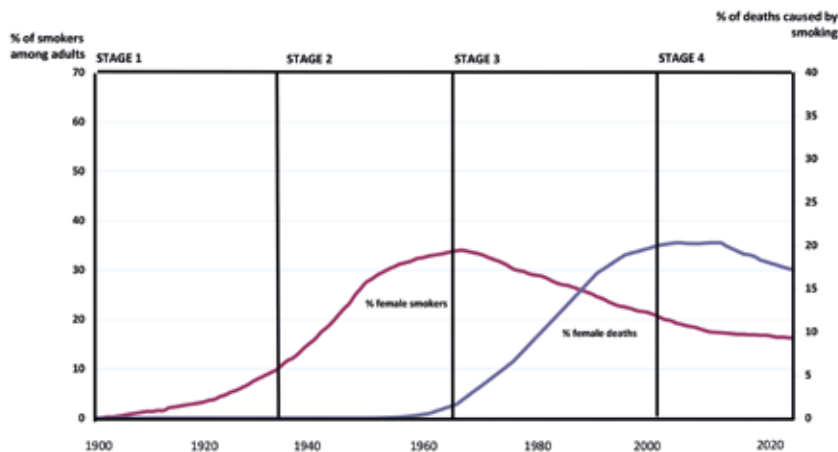
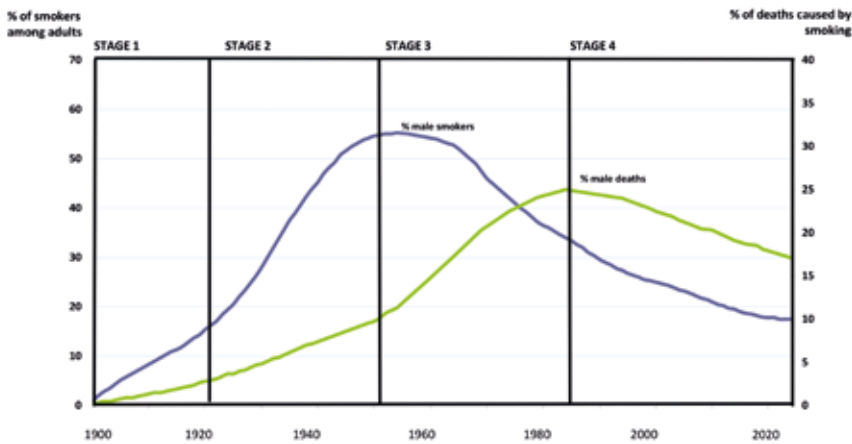

Stages of the tobacco epidemic in men (top) and women (bottom). In both sexes, the increase and decrease in the percentage of people smoking is paralleled some 20 years later by an increase and a decrease in tobacco-related deaths from diseases, including cancers, that take decades to develop.

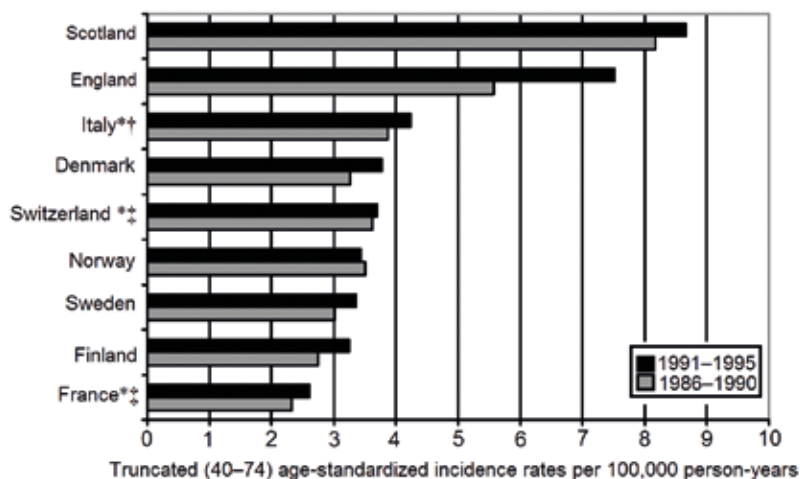

Mesothelioma incidence rates (cases per 100 000 men per year) age-standardized to a common population in two time periods. In all countries except Norway, an increase was observed from 1986–1990 to 1991–1995.

* Selected areas only.
 † First period = 1987–1990.
 ‡ First period = 1988–1990.

For less common cancers, more targeted investigations are required. Mesothelioma is a malignant tumour of the pleura and peritoneum that develops several decades after exposure to asbestos, the only well-established cause. A collaborative study by epidemiologists from IARC and European mesothelioma registries showed the increase in mesothelioma incidence rates between two successive time periods. This increasing trend has continued into the 21st century, reflecting high exposure to asbestos in the past, mostly as a result of the occupations of the people affected. It can be expected that as a result of the ban on the use of asbestos, mesothelioma incidence rates will stop increasing and start decreasing. A hint of this may be the slight decline seen in the figure for Norway, the first country to introduce the ban (in 1984). Another example in which the removal of an exposure from a population led to a subsequent decline in cancer rates came from work conducted by IARC with colleagues in Australia. The painkiller phenacetin, which causes kidney disease and was marketed in particular to women, was banned in Australia in the late 1970s. A corresponding decline in the incidence of a rare type of kidney cancer was observed some 30 years later using data from cancer registries that covered 95% of the Australian population.

Survival of cancer patients

Improved survival of cancer patients is the yardstick of success of treatments. However, the survival as measured from the statistics of a specialized oncology service may be quite different from the survival measured for all patients with, say, lung cancer in a given population, wherever they have been taken care of and whatever the treatment they have actually received. Often the average survival time is longer for patients treated at specialized cancer centres than for all patients considered together. This is because some patients may have had delayed diagnoses, less optimal treatment, and less systematic follow-up for relapses and complications. However, from a public health viewpoint, the average survival time of all patients is considered because it reflects the experience of the population as a whole.

IARC has catalysed the collection of such cancer survival statistics in Europe, and more recently in Africa, Asia, the Caribbean, and Central America. Information on survival of cancer patients in developing countries is relatively rare. This emphasis by IARC has been important in highlighting the poor situation in

some countries and also in indicating how significant improvements can be made, even in countries with limited resources, if these are directed towards the early detection and treatment of the disease.

In Europe, the EUROCARE study, which was started in 1989, has developed into an autonomous research project that by 2014 had produced five successive cycles of survival analyses. EUROCARE has documented both a general improvement over time and important differences between countries. IARC epidemiologists participate in studies investigating the determinants of such differences. A recent example is an investigation that points to early management, immediately after diagnosis, as the likely reason for a difference in 1-year survival between patients with colorectal cancer in England and in France.

THE BURDEN OF CANCER

In 1984, IARC and WHO epidemiologists produced a first estimate of the frequency of occurrence of 12 major cancers worldwide in about 1975. The world was subdivided into 24 areas, and incidence figures were derived either directly (where data on cancers recorded by cancer registries were available) or, for several large areas, only indirectly via mortality data. The total number of new cancer cases per year was close to 6 million. In men, lung cancer was the most frequent, followed by cancers of the stomach and of the colon and rectum. In women, cancers of the breast, cervix, and stomach ranked highest. Of the 6 million new cases per year, it could be roughly estimated that up to 1 million were attributable to tobacco smoking and were therefore, in principle, preventable. Already at that time, the authors noted that in most developing countries the impact of cancer had been underestimated but that the decrease in mortality from infectious diseases resulted in increasing numbers of people of middle age and older at risk of developing cancer.

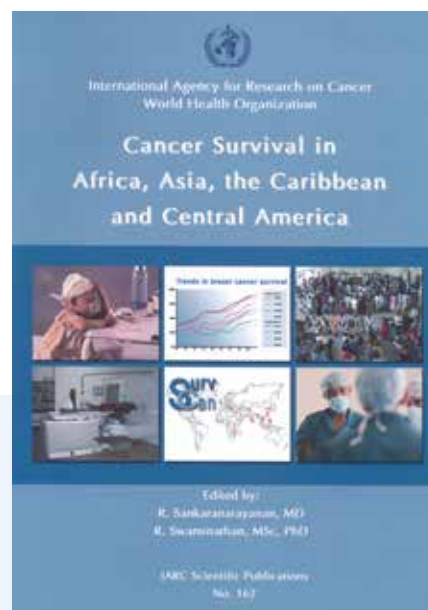
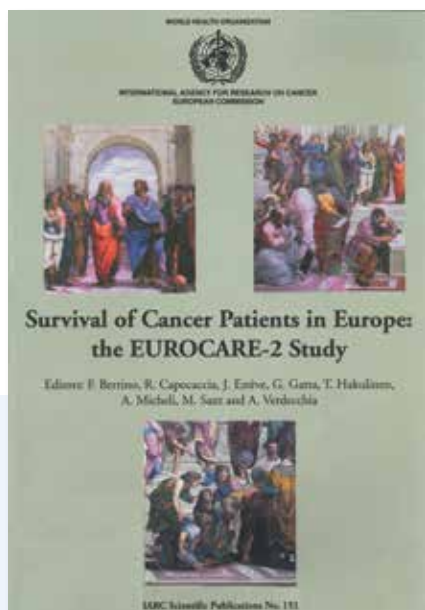
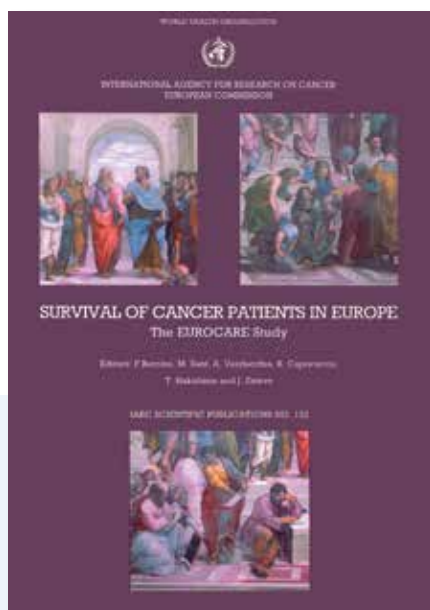

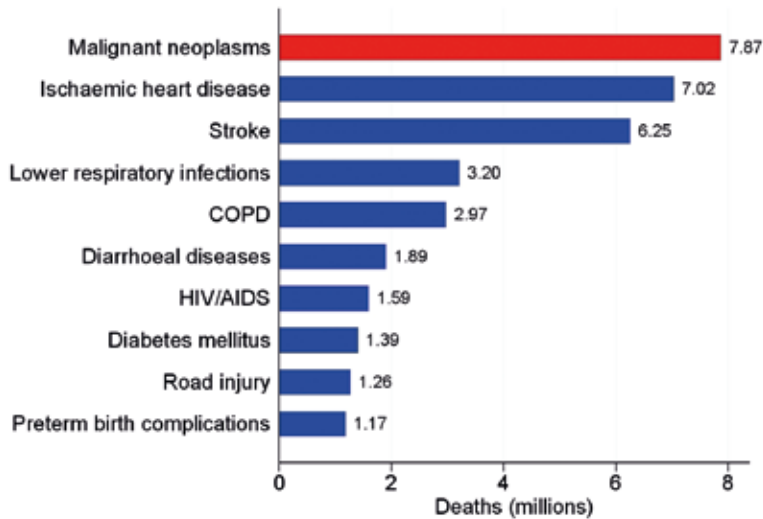

The 10 leading causes of death worldwide in 2011 (COPD, chronic obstructive pulmonary disease).

With the expansion of cancer registry coverage throughout the world, better estimates of cancer incidence became possible, and these were published by IARC for 1980 and subsequently at about 10-year intervals. Estimates of prevalence were also added (i.e. the number of living people who have been diagnosed with cancer), an important indicator of the burden on health services from people in need of clinical surveillance and, often, of treatment.

In 2011, there were nearly 8 million cancer-related deaths. All cancers, taken together, are now a leading cause of death worldwide, responsible for 14% of the total of 55 million deaths from all causes. When all main cardiovascular diseases (i.e. ischaemic heart disease and stroke) are similarly taken together, they are responsible for more than 13 million deaths, about 25% of the total. It is estimated that 14 million new cancer cases are diagnosed each year worldwide, and about 33 million living people have been diagnosed with cancer within the previous 5 years.

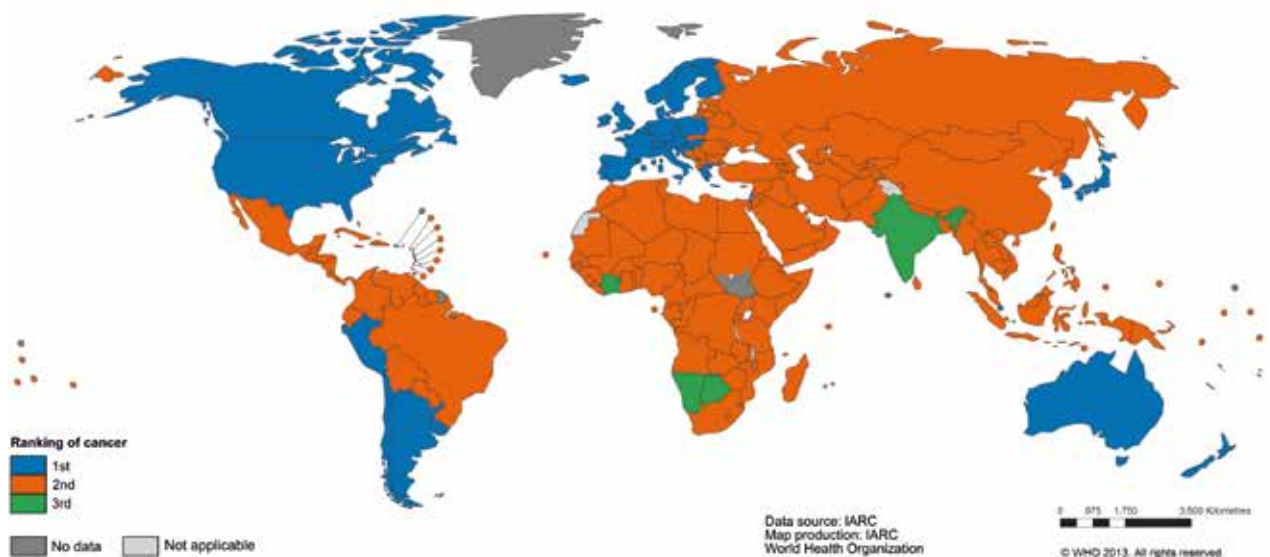

Ranking of cancers as a cause of premature mortality (ages 30–69 years), compared with cardiovascular disease and diabetes (combined) and chronic obstructive pulmonary disease, for both sexes, estimated for 2011.

High/Very High HDI: 7.9 million new cases

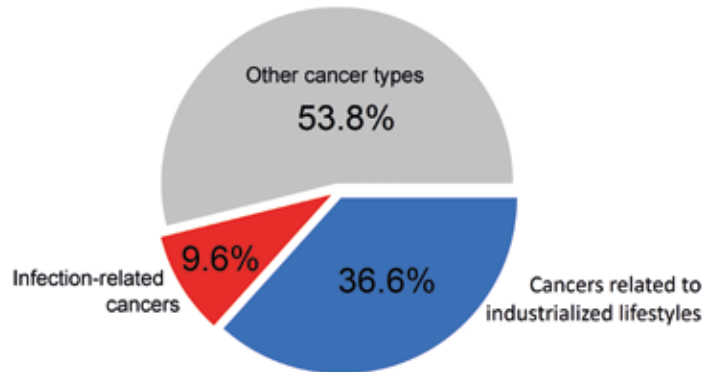

Low/Medium HDI: 6.2 million new cases

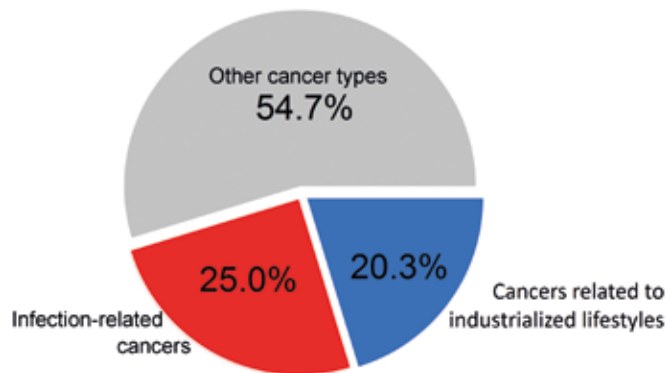

Estimated number of new cases of cancer in 2012 by categories of Human Development Index (HDI). Within each HDI category are shown the percentages of cancers attributable to infections (cervical, liver, and stomach cancers and Kaposi sarcoma) and related to industrialized lifestyles (colorectal cancer, female breast cancer, and prostate cancer).

The economic and demographic changes that are under way have blurred the categorization of countries as economically “developed” or “developing”, the terms used by IARC for decades when presenting the estimates of cancer burden by broad regions. Recently, a categorization in terms of Human Development Index (HDI) has been introduced, and was used in the third edition of IARC’s *World Cancer Report* (in 2014). HDI captures three dimensions of human development: life expectancy at birth, educational level attained, and purchasing power. With HDI, populations can be reclassified in a more meaningful way than with the traditional “developed”/“developing” dichotomy. With this new categorization, close to 8 million new cases of cancer occur per year in countries with high or very high HDI, whereas the annual burden on countries with low or medium HDI is about 6 million. In countries with low or medium HDI, a quarter of cancers are infection-related, and in countries with high or very high HDI, more than a third of cancers are related to industrialized lifestyles.

John Higginson, the first IARC Director, was among the first to put forward, in the 1960s, the concept that the great majority of cancers are primarily caused by environmental agents in the broad sense, i.e. agents that are not constitutive of a person's genetic make-up (see the chapter "Carcinogens in the human environment"). Since then, a vast literature has flourished that attempts to quantify the "great majority" and to divide it among major categories of causes (tobacco smoking, alcohol consumption, type of diet, workplace environment, etc.). Obtaining accurate and precise estimates of the proportion of cancers attributable to each category entails major methodological challenges. Notwithstanding these challenges, the best available measures were presented and discussed in the first and second editions of IARC's *World Cancer Report* (in 2003 and 2008). More recently, IARC has placed great emphasis on providing reliable estimates, reporting on the number of cancers worldwide linked to infections and to overweight (see "Overweight and cancer").

Incidence rates (new cases per 100 000 people per year), age-standardized to a common world population, for the seven most common cancers

Cancer	Incidence rate in men			Incidence rate in women		
	Highest	Lowest	Ratio	Highest	Lowest	Ratio
Lung	87	3	29	61	1	61
Breast	2	0	—	107	9	12
Colon and rectum	64	3	21	45	2	22
Prostate	190	1	190	—	—	—
Stomach	111	2	56	46	1	46
Liver	61	2	30	22	1	22
Uterine cervix	—	—	—	65	2	33

The table shows the variation of incidence rates for the seven most common cancers worldwide. From the rates reported for each of the individual cancer registries in *Cancer Incidence in Five Continents*, Volume X (2013), the highest and the lowest have been selected (and rounded) for men and women. The rates vary widely between populations, with ratios of the highest to the lowest of one to two orders of magnitude, pointing to variations in the environment of the populations as the likely main causal factors of the cancers.

OVERWEIGHT AND CANCER

In most developed countries, a substantial proportion of people are overweight, an observation confirmed by recent statistical estimates that the global frequency of excess body weight in adults increased by more than 25% between 1980 and 2013. Overall, about 35% of the adult population of the world is overweight. This is an obvious cause for concern, given the established knowledge – based on numerous and consistent studies – that overweight increases the risk not only of cardiovascular diseases and diabetes but also of several cancers, including cancers of the colorectum, pancreas, gall bladder, and breast.

What proportion of all cancers can be attributed to overweight? This proportion, called the population attributable fraction, was calculated using figures for cancer incidence from GLOBOCAN 2012 and survey data for overweight, expressed in terms of body mass index, as available from the Global Burden of Metabolic Risk Factors of Chronic Diseases Collaborating Group. Body mass index is calculated as weight (in kilograms) divided by the square of height (in metres); a value of 25 or more is generally accepted as indicating excess weight, and a value of 30 or more indicates obesity. The world map shows that the proportion of cancers attributable to overweight varies from less than 0.3% to more than 5% for men and from less than 1.6% to more than 12% for women. Overall, an estimated 3.6% (i.e. more than 480 000) of all new cancer cases in adults in 2012 were attributable to excess weight or obesity. These quantitative findings stress the pressing need to control the spread of the overweight epidemic globally.

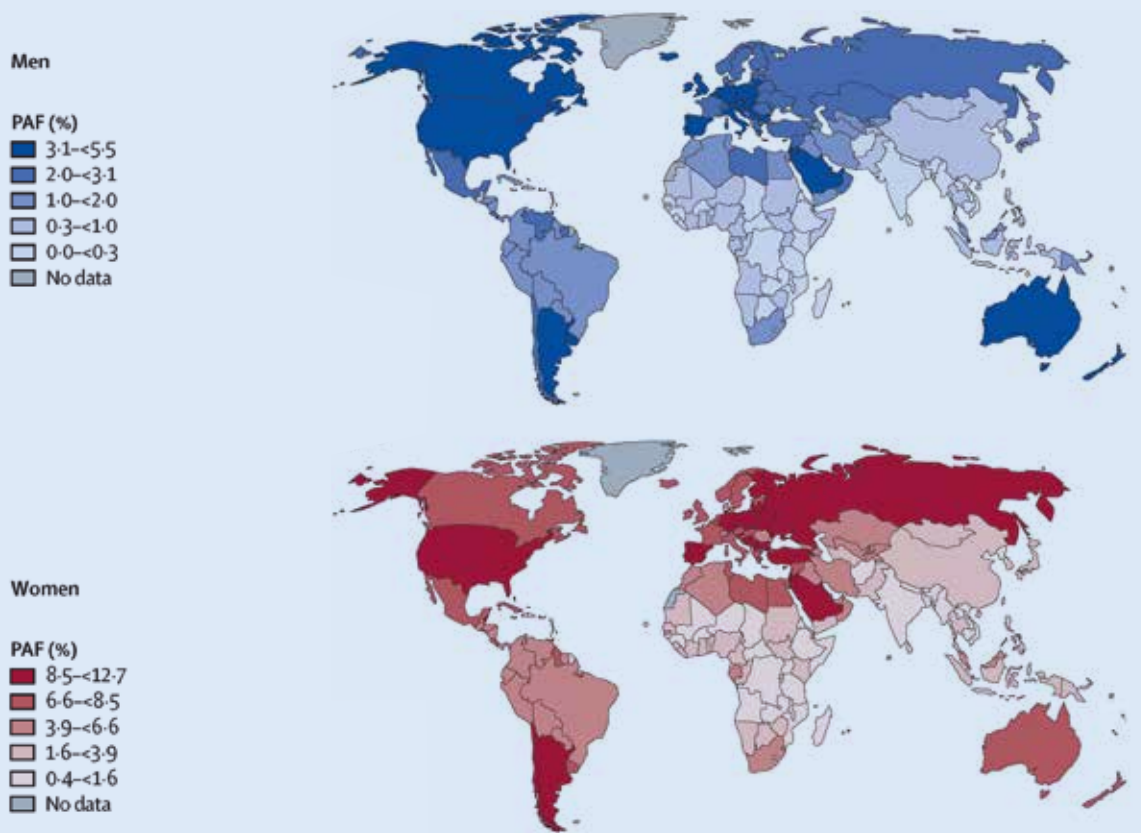

Population attributable fraction (PAF) of new cancer cases in 2012 caused by high body mass index (a value of 25 or more) in men and women, by country.

The important message emerging from these analyses is that – as stated in the preface to *World Cancer Report 2014*, edited by Bernard W. Stewart and Christopher Wild – “Since the middle of the last century, enormous progress has been made in identifying the causes of cancer, so that more than 50% of cases could be prevented based on current knowledge.” However, one should not forget that the global variations in cancer incidence, as obtained from cancer registries, imply that the overall proportion of cancers that are potentially preventable is even higher than this figure. Thus, the search for causes of cancer continues, still stimulated in many cases by the intriguing variation in patterns seen when comparing one population with another.



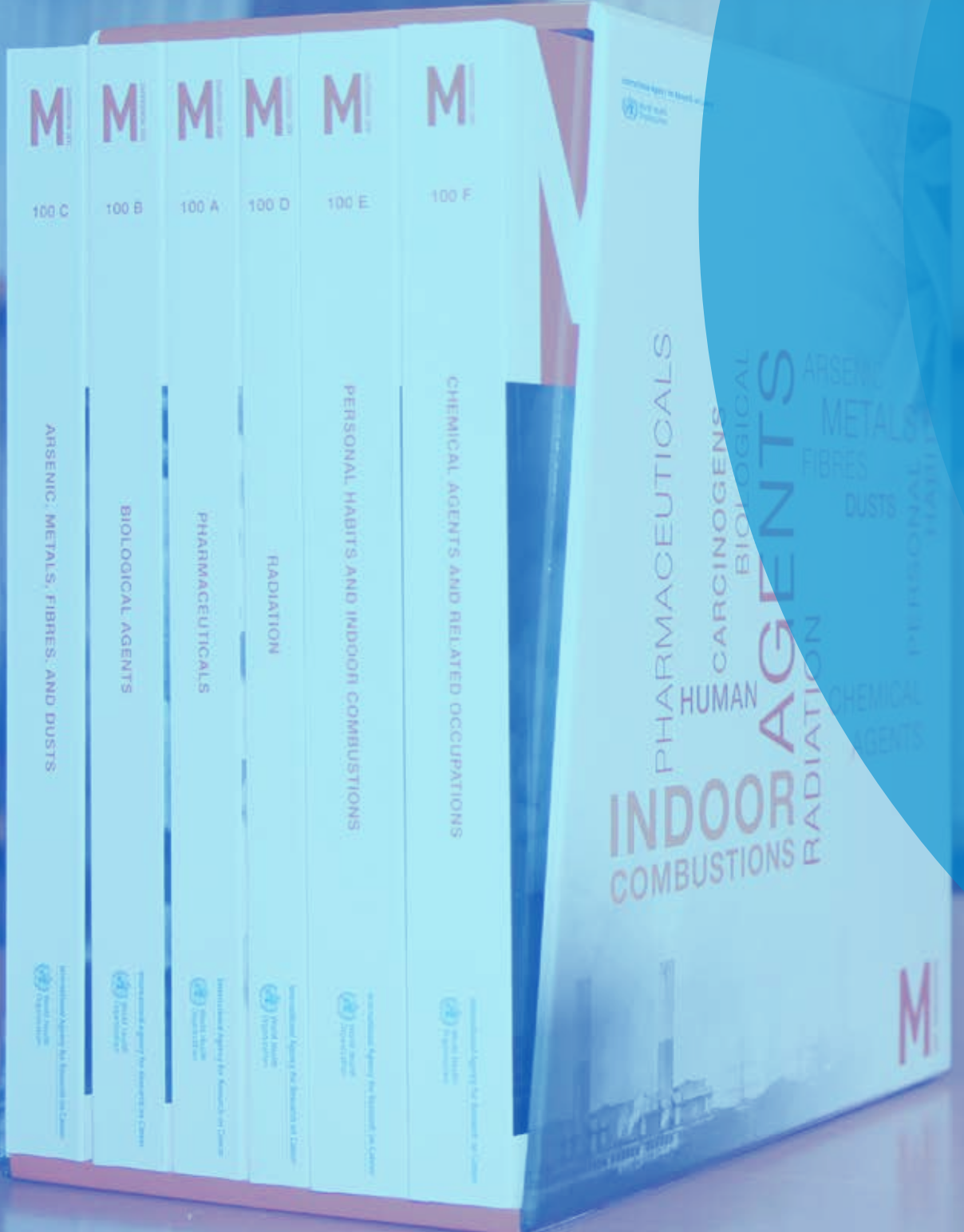

CARCINOGENS IN THE HUMAN ENVIRONMENT

CARCINOGENS IN THE HUMAN ENVIRONMENT

By the second half of the 1960s, it had become evident that several physical, chemical, and biological agents could cause cancer in humans, as reviewed in Richard Doll's book *Prevention of Cancer: Pointers from Epidemiology* in 1967. Alongside epidemiology, long-term experiments with animals (typically mice, rats, or hamsters) exposed to high doses of chemical substances, such as soot and coal tars, clearly showed the capacity of such substances to induce cancer. The two approaches – observations in humans and laboratory experiments with animals – to identify carcinogens, natural or man-made, were at the same time complementary and in “useful tension”. Epidemiology is based on direct evidence in humans, and hence it is the litmus test of carcinogenicity, but this very fact implies that several cancers due to a substance have already occurred. From a cancer prevention viewpoint, evidence from animal experiments is far preferable, as it enables the avoidance of exposure of humans to experimentally recognized carcinogens. The drawback is that what happens, or does not happen, in animals does not necessarily match what occurs in humans. Thus, in the mid-1960s, there was one striking discrepancy between epidemiological and experimental evidence: tobacco smoking could be clearly demonstrated to cause cancer in humans, but at the time no proof of carcinogenicity of tobacco smoke could be obtained in animal experiments.

Starting as early as 1969, IARC capitalized on the complementary nature of the two approaches rather than standing aside because of possible discordances. IARC developed two main long-term focus areas aimed at identifying carcinogens in the human environment: the IARC Monographs Programme, with its systematic reviews of all published epidemiological and experimental evidence of carcinogenicity of (initially) chemicals; and epidemiological studies on specific human exposures arising from occupation or the general environment. In addition, during IARC's first two decades, several animal carcinogenicity experiments were conducted at the Agency (see “DDT and transplacental and transgenerational carcinogenesis”).

THE IARC MONOGRAPHS, A WORLD REFERENCE FOR ENVIRONMENTAL CARCINOGENS

A systematic approach to the evaluation of scientific evidence

After a preparatory phase, the Monographs Programme was launched in 1971–1972 at the initiative of and under the leadership of Lorenzo Tomatis (see “Lorenzo Tomatis, second IARC Director”). The aim was to develop an instrument capable of evaluating the best evidence available at a given time on carcinogenic agents, in order to provide a sound scientific basis for cancer prevention. Some reviews of the evidence of carcinogenicity had already been published, including Doll's book *Prevention of Cancer: Pointers from Epidemiology*. However, two features made the IARC programme highly innovative:



The effective use of DDT as an insecticide to control malaria was far exceeded by its use for pest control in agriculture and forestry. DDT is one of a host of pesticide chemicals of concern because of their accumulation, persistence, and toxic effects in living organisms.

DDT AND TRANSPLACENTAL AND TRANSGENERATIONAL CARCINOGENESIS

It was not within IARC's remit to develop a large facility for testing suspected carcinogenic substances in long-term experiments in animals. However, IARC laboratories participated in collaborative studies, contributing data to much larger, multilaboratory experiments. In 1981, some 15 years after IARC was established, a dozen such collaborations were active, involving some pesticides, industrial chemicals, and pharmaceutical drugs. More complete studies conducted at IARC focused on issues of prominent public health relevance. Following a 1967 recommendation by a joint meeting of the World Health Organization (WHO) and the Food and Agriculture Organization of the United Nations, dichlorodiphenyltrichloroethane (DDT), a chemical widely used as an effective insecticide against the malaria mosquito, was tested in long-term experiments in mice. These involved more than 1000 animals, and more than 3000 when the observation was expanded to cover six generations. An increased incidence of liver-cell tumours was found in DDT-treated mice compared with untreated controls, at the highest doses (250 milligrams per kilogram of body weight) of oral DDT administration. These results were supported by those of smaller studies in mice, rats, and hamsters carried out at other laboratories, leading in 1991 to the evaluation by the IARC Monographs Programme that there is sufficient evidence for the carcinogenicity of DDT in experimental animals.

At that time, the epidemiological data from humans exposed to DDT were inconclusive. Minor increases in the incidence of lung cancer and cancers of the blood and lymphatic organs had been inconsistently reported by studies with limitations in the assessment of exposure to DDT and in the control of other possible carcinogenic factors. Considering the combined evidence in experimental animals and humans, DDT was classified as *possibly carcinogenic to humans*, and epidemiological reports published subsequently, particularly on breast cancer, have not improved the evidence. This immediately posed a dilemma: should use of DDT be continued for malaria control, while paying the price of a possible increase in cancer cases? Balancing benefits and risks of interventions is common in public health. In 2002, Lorenzo Tomatis and his collaborators who had conducted the IARC experiments in the 1960s concluded, "There is a general consensus that limited and strictly controlled use of DDT should be allowed for public health purposes, in particular where other effective, safe, and affordable alternatives are not available, and the benefits are clearly far superior to possible risks. ... A total ban of DDT could only be achieved at a cost that poor countries ... cannot afford without substantial and long-term financial help from the richer countries." Unfortunately, the "strictly controlled use" was not respected, as DDT was later applied far more widely as a pesticide in agriculture and forestry than specifically to combat malaria.

The DDT experiments at IARC were conducted over several generations of mice, and the possible cancer induction in the offspring of parents exposed to carcinogens became a research area in itself, of wider scientific interest well beyond the case of DDT. A collaboration was established with several laboratories to carry out animal experiments investigating the two possible ways in which exposure of parents could in principle induce the appearance of cancers in offspring: because a carcinogen to which the mother was exposed reached the cells of the embryo or fetus via the placenta, or because a carcinogen had affected the germ cells (sperm or ova) of the father and/or the mother. Results from this collaboration suggested that both mechanisms may in fact be operating. These studies were early forerunners of the contemporary expansion of research on transplacental and transgenerational carcinogenesis made possible by advances in molecular genomics and epigenetics.

the systematic approach to examining and evaluating each agent by the same procedures, and the idea that the soundest way to reach the "truth" about the carcinogenicity of an agent is through open discussion and reciprocal cross-checking by leading experts. Given the imperfect nature of all human knowledge, the truth is always approximate, but it can be explicitly stated and qualified by the degree of confidence attached to the statement.

In practice, scientific judgement can be distorted by secondary interests and goals extraneous to, and interfering with, the primary goal of pursuing scientific, reasonable truth, such as financial incentives or advocacy standpoints. Hence, the experts chosen to participate in evaluations had to be as free as possible of such conflicting interests.

LORENZO TOMATIS, SECOND IARC DIRECTOR

Lorenzo Tomatis succeeded John Higginson in 1982 as IARC Director, a post he held until 1993. After graduating from the University of Turin with a degree in medicine, Tomatis pursued a research career in experimental cancer pathology in the laboratory of Philippe Shubik at the University of Chicago, a leading centre in the study of mechanisms of carcinogenesis. His research focused on the induction of cancer by chemical agents, with a special interest in cancers appearing in the offspring of parent animals exposed to carcinogens. Tomatis joined IARC in 1967 as head of the Unit of Chemical Carcinogenesis and was the founder of the IARC Monographs Programme. He consistently supported a close connection between scientific rigour in research and public health interest as enacted through cancer prevention. In 2002, Tomatis wrote, "In the absence of absolute certainty, rarely if ever reached in biology, it is essential to adopt an attitude of responsible caution, in line with the principles of primary prevention, the only one that may prevent unlimited experimentation on the entire human species." He cautioned that "absent or inadequate epidemiological data cannot be considered equivalent to a negative finding and cannot be considered more relevant for public health than positive experimental findings."

As a keen observer of society, Tomatis was well aware that primary prevention of cancer can be implemented only by overcoming major obstacles. In 2006, he wrote that "primary prevention of cancer has stumbled from the very beginning because of the interference of powerful economic interests which perceived that any data indicating a probable cancer risk after exposure to industrial chemicals jeopardizes their profits, the protection of which being more important than the protection of human health." The high international status of the IARC Monographs Programme stands as a lasting tribute to Tomatis's scientific and humanistic intelligence.



Lorenzo Tomatis was IARC Director from 1982 to 1993.

An evolving programme

To fit its purpose, the Monographs Programme needed to be evolutionary, in the dual sense of incorporating updates of the evidence when relevant new findings become available and of adapting the very criteria used to evaluate such evidence in line with the accruing knowledge about the underlying mechanisms of cancer development. Over more than 40 years, the programme has successfully maintained and strengthened these characteristics, becoming a key reference – often *the* key reference – in both scientific and public health contexts.

The initial selection of agents to be considered centred on chemicals, for several of which data on carcinogenicity had been accumulating. For each compound evaluated, a Monograph was to be prepared and published. From the colour of the cover, the volumes soon became known as the “Orange Books”.

Each Monograph was produced by a Working Group composed of the world’s leading experts, who met in Lyon for 7–10 days, with staff from IARC serving as the supporting secretariat. During the meeting, initial drafts prepared in advance by different Working Group members were discussed and repeatedly revised to reach the final text of the Monograph sections. Each Monograph reviewed in detail all available reports published in the scientific literature on the occurrence of and human exposure to the compound, studies of cancer in experimental animals and in humans, and other relevant biological data. A summary of the sections and an evaluation of whether the compound should be regarded as carcinogenic to humans concluded each Monograph.



Public health measures and decisions were up to countries, but they needed a document that showed clearly that there was evidence, and it was the Monographs.
– Ruggero Montesano, former IARC scientist

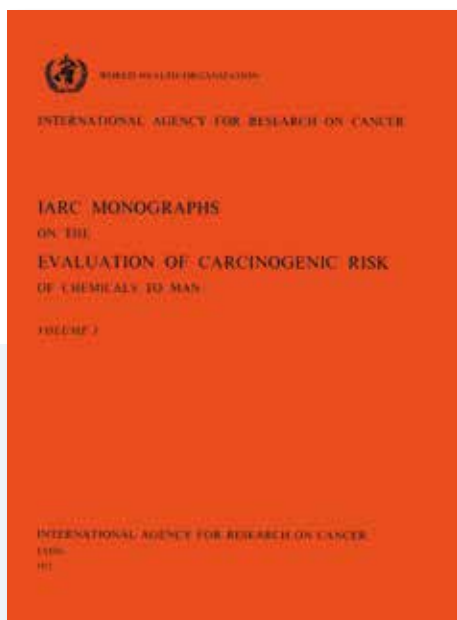

The first volume of the IARC Monographs series was published in 1972. It covered evaluations of some inorganic substances (e.g. beryllium), chloroform, several aromatic amines, nitroso compounds, and natural products (including aflatoxins).

The first two volumes, each containing several Monographs, were published in 1972 and 1973. They already concluded that several chemicals caused cancer in humans, among them aromatic amines, asbestos fibres of all kinds, and nickel. The evaluations were expressed in a narrative style with variable language as suited to each Working Group. Soon, the need emerged to introduce some measure of uniformity and a grading of the evidence of carcinogenicity, which sometimes appeared definite, sometimes was limited, and sometimes was simply absent. Accordingly, the short general Preamble that introduced each Monograph was expanded to provide procedural and writing guidance to the Working Groups. Suggestions from their

THE IARC CLASSIFICATION OF CARCINOGENS

The IARC classification, which was adopted in 1987–1988 on the basis of more than 15 years of experience in evaluating potentially carcinogenic agents, constitutes one of the first evidence-based systems in biomedicine. At about the same time (in the early 1990s), the term “evidence-based medicine” was introduced in clinical research. The classification as it is used today is based on the following five elements.

- (a) The evidence of carcinogenicity from studies in humans is evaluated and classified into one of four categories: sufficient evidence of carcinogenicity, limited evidence of carcinogenicity, inadequate evidence of carcinogenicity (which also covers agents for which there are no data), or evidence suggesting lack of carcinogenicity.
- (b) The evidence of carcinogenicity in experimental animals is evaluated separately and is classified into one of the same four categories as in (a).
- (c) Mechanistic and other relevant data are described.
- (d) The body of evidence in (a), (b), and (c) is considered as a whole to reach an overall evaluation in one of the following categories.
 - Group 1: The agent is *carcinogenic to humans*.
 - Group 2A: The agent is *probably carcinogenic to humans*.
 - Group 2B: The agent is *possibly carcinogenic to humans*.
 - Group 3: The agent is *not classifiable as to its carcinogenicity to humans*.
 - Group 4: The agent is *probably not carcinogenic to humans*.
- (e) A Rationale section explains the main lines of reasoning that the Working Group used to reach its evaluation and classification. Should significant differences of scientific interpretation occur among Working Group members, a summary of the alternative interpretations is provided.

Of 971 agents evaluated so far (many of which have also been re-evaluated when new data have accrued), 114 fall into Group 1, 69 into Group 2A, 283 into Group 2B, 504 into Group 3, and 1 into Group 4. The reason why almost half of the 971 agents have been found to be positive, in different degrees, for carcinogenicity while only one agent has been classified in Group 4 is that agents are selected for evaluation only when information is available that makes them suspected carcinogens. It would not make any sense, and would be wasteful of resources, to pick agents for evaluation at random out of the millions in existence.

The continuously updated evaluations are available on the IARC Monographs website at monographs.iarc.fr. The IARC Group classification is a regular reference when dealing with an agent's carcinogenicity in a scientific or public health context and is also very often quoted in the lay media. Occasionally, however, it appears that the correct meaning has not been grasped, particularly for Group 2 classifications: the expressions *probably* and, even more, *possibly* are interpreted as meaning that the agent is capable of increasing the risk of cancer but that the increase in risk is small. This is incorrect; *probably* and *possibly* do not refer to the size of an increased risk. They indicate higher (*probably*) or lower (*possibly*) probabilities that such an increased risk induced by the agent does in fact exist.

These are not easy scientific judgements, and each evaluation is anything but a mechanical operation of pigeonholing agents into categories. Intensive discussions and repeated revisions of the Monograph text take place during what is nowadays an eight-day-long meeting. The Working Group meets in plenary sessions to examine, modify, and finalize the drafts prepared by specialized subgroups; among these, the subgroup dealing with exposure data for the agent being evaluated is of critical importance. Evenings and weekends are often busy as well, and although Lyon has a well-deserved reputation as a capital of gastronomy, usually only a single escape for a group dinner is possible. Despite the challenges, a shared view within the Working Group most often emerges after the long hours of in-depth scientific debate. Nevertheless, reaching such agreement can be problematic when the evidence seems to straddle the boundary between two adjacent categories. For example, radiofrequency electromagnetic fields as generated by mobile phones were evaluated by the Monographs Programme in 2011 and categorized as *possibly carcinogenic to humans* (Group 2B), a statement widely quoted in the media that reflects different nuances of interpretation of the available evidence. In fact, the section of the Monograph entitled "Rationale of the evaluation of the epidemiological evidence" points out that inconsistencies between the results of different studies were regarded by the majority of the Working Group members as a restriction on the evidence, leading to a judgement of *limited evidence* of carcinogenicity in humans; however, there was a minority opinion that saw the same inconsistencies as more critical, viewing the current evidence in humans as *inadequate*.

experience and discussions in several ad hoc meetings consolidated the guide into formal criteria; the format adopted in 1987–1988 is essentially still used today (see "The IARC classification of carcinogens").

The Monographs Programme had started with the general title of IARC Monographs on the Evaluation of Carcinogenic Risk of Chemicals to Man ("man" became "humans" in 1978). Recognizing the high quality of the programme, several leading scientists had argued that it should not be limited to individual



The six-book boxed set of IARC Monographs, Volume 100: A Review of Human Carcinogens.

chemicals but expanded to (in Richard Peto's words) "see chemical carcinogens, lifestyle factors, and chronic infections as being separately important, placing cancer causes in a more balanced perspective." Since its reshaping in 1987–1988, the series has been called the IARC Monographs on the Evaluation of Carcinogenic Risks to Humans, to denote the much-enlarged scope of the programme, covering physical, chemical, and biological agents as well as mixtures of compounds (like tobacco smoke) and circumstances not specifiable more precisely (like some occupations). This breadth has led to many important evaluations by the IARC Monographs Programme, for example of infectious agents including viruses (e.g. hepatitis B and C viruses, human papillomaviruses), bacteria (e.g. *Helicobacter pylori*), and parasites (e.g. *Schistosoma mansoni*) and of physical agents including ultraviolet radiation and radon.

Two other major adaptations have taken place over the years. First, taking into account the increasing knowledge about mechanisms through which an agent like a chemical or a virus can induce cancer, mechanistic data have been given increased weight in assessing whether an agent is carcinogenic. Several chemicals have been classified as carcinogenic to humans when the direct epidemiological evidence was insufficient but there was strong evidence in exposed humans that the agent acts through a known relevant mechanism of carcinogenesis. (For example, the molecules of some dyes are metabolized in the human body to benzidine, a molecule for which there is direct epidemiological evidence of carcinogenicity.) For almost all of these agents, there was, in addition, sufficient evidence of carcinogenicity in animals.



I was impressed by the thoroughness of the Monographs Programme. It provided an international gold standard for the process, assessment criteria, and presentation of the assessed carcinogenicity of specified exposures.

– Tony McMichael, former chair,
IARC Scientific Council

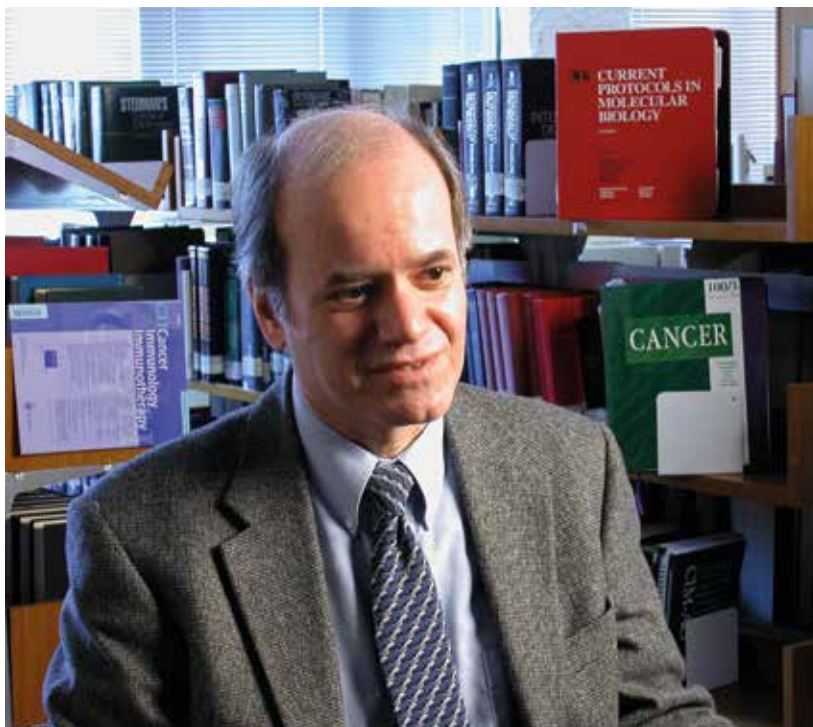

Vincent Cogliano, head of the Monographs Programme from 2003 to 2010, coordinated the operation of the Working Groups evaluating the evidence and the production of the Volume 100 books. Cogliano joins Lorenzo Tomatis, Harri Vainio, and Jerry Rice as one of the group of people who have led the Monographs Programme for extended periods over its history.

Second, the roles of the participants at Monographs meetings have been better specified. Working Group members are responsible for the critical reviews and evaluations that are developed during the meeting. Invited specialists and representatives of national and international health agencies contribute their expertise but do not serve as meeting chair or subgroup chair, draft text, or participate in the evaluations. A limited number of observers, for example from industry or nongovernmental organizations, with relevant scientific credentials may be admitted under well-defined guidelines on the restrictions on their participation. IARC staff act as the supporting secretariat, serving as rapporteurs and participating in all discussions.

A recent addition to the programme is Volume 100 of the Monographs series, which consists of six books summarizing the most up-to-date evidence for the 110 agents previously classified in Group 1 (carcinogenic to humans). Volumes 100A to 100F cover pharmaceuticals; biological agents; arsenic, metals, fibres, and dusts; radiation (ionizing and non-ionizing); personal habits and indoor combustions; and chemical agents and related occupations. These summaries include an assessment of the specific organs for which sufficient evidence is available that an agent induces cancer, with the proviso that when an agent is shown to be carcinogenic for some organs it cannot be excluded that other organs might be affected as well.

AFLATOXIN AND PRIMARY LIVER CANCER

Scattered reports from different localities in Africa had pointed out a possible high frequency of primary liver cancer, a rare tumour in developed countries. One of the earliest meetings at IARC, held before the move to the newly constructed IARC tower building, considered the causes of primary hepatoma. Indeed, as early as 1967 a collaborative centre had been established in Nairobi, Kenya, to supervise IARC research projects in East and Central Africa (see the chapter “The birth of IARC”).

The Murang'a district of the Central Province of Kenya was selected for an investigation relating cancer occurrence to environmental contamination of the local diet by aflatoxins – metabolites produced by microscopic fungi (*Aspergillus* species) and already known to be potent toxins and liver carcinogens in animals accidentally exposed or treated experimentally in the laboratory. A field survey was conducted to collect random samples of food and beer representative of the actual food consumed by several thousand people, more than half of them children. Laboratory analyses for aflatoxin content were performed at the IARC Regional Centre in Nairobi, and cases of liver cancer were registered in 1967–1970. The data shown in the table on the next page were collected in areas at different altitudes, where conditions of moisture and temperature could be differently favourable to food contamination by *Aspergilli*. The aflatoxin content of food samples and the proportion of samples positive for the presence of aflatoxin increased with the decreasing average altitude of the sampled area. The frequency of hepatoma (cases per 100 000 adults per year) showed a parallel increase.



Until 1972, IARC was housed in a late-19th-century building in central Lyon, where this October 1968 meeting on the causes of liver cancer took place. Frank Peers (at extreme left), Allen Linsell (fourth from left), and Gregory O’Conor (sixth from left) were the principal investigators for IARC’s research projects in Africa on the role of aflatoxin and hepatitis B virus infection. Albert Tuyns (fifth from left) was the IARC epidemiologist who conducted the studies on the causes of oesophageal cancer in north-western France (see the chapter “Innovation in statistical methods”).

Aflatoxin contamination of “food from the plate” samples in three areas of the Murang’a district, Kenya

Characteristic	Average altitude of area		
	High	Medium	Low
Aflatoxin content of food samples (micrograms per kilogram)	3.5	5.9	10.0
Proportion of positive samples	39/808	54/808	78/816
Hepatoma incidence:			
Total number of cases (1967–1970)	1	19	12
Number of cases per 100 000 adults per year	1.3	6.3	8.0

As stated in the 1970 IARC Annual Report, “There appears to be a definite correlation between aflatoxin levels and current liver cancer cases in the three sub-areas of different altitude in Murang’a. ... However, it is necessary to extend this study to other areas in the world with different cancer rates and levels of aflatoxin contamination, if the hypothetical association between aflatoxin ingestion in man and hepatocellular cancer is to be adequately tested.”

A field team from the IARC Regional Centre in Nairobi visiting a village to collect samples of foodstuffs for the aflatoxin research programme, in 1968.



With characteristic prudence, the first volume of the IARC Monographs (in 1972) reported that in the judgement of the Working Group no causal relationship had been established between cancer occurrence and aflatoxin contamination of diets. As data similar to those from Murang'a became available from other localities, the position had changed by Volume 10 of the Monographs (in 1976): "The studies of liver cancer incidence in relation to aflatoxin intake provide circumstantial evidence of a causal relationship." Ten years later, results from two case-control studies in Shanghai and Taiwan, China and one small cohort study in the Netherlands enabled the definitive conclusion that aflatoxin is carcinogenic to humans. In the meantime, IARC conducted an investigation in 11 areas of Swaziland, in which both aflatoxin consumption and prevalence of hepatitis B virus infection were measured. The results showed that both were related to liver cancer occurrence but that aflatoxin exposure appeared to be more important in explaining the variation in liver cancer incidence. Over the decades, IARC has contributed much further knowledge on the role and mechanisms of action of aflatoxin and its interaction with hepatitis B virus infection, particularly within the Gambia Hepatitis Intervention Study (see the chapter "Viruses and vaccines") and with research on the role of the *TP53* gene and protein (see the chapter "From laboratory to population"). The aflatoxin story continues to unfold, with a focus today on preventive measures against food contamination. IARC's early evidence from Murang'a had paved the way.

EPIDEMIOLOGICAL STUDIES

Since the very beginning, IARC has engaged in a variety of epidemiological studies of possible carcinogens in the general, home, and occupational environments. These studies took different forms in different contexts.

Cancer hotspots

A first type of epidemiological study consisted of building on the suggestions, often coming from clinical observations or crudely recorded data on a geographical basis, that there were hotspots of cancer incidence in areas where some characteristic exposure was reported as common. Most often this occurred in developing countries, and IARC established collaborations in those areas with local health professionals who provided, directly and via official government channels, scientific support to mount rigorous epidemiological and laboratory investigations designed to put the suggestions to the test. Significant results were soon obtained, of value locally for the populations concerned and also of broader significance for the knowledge of new carcinogens.

Early examples of potent environmental contaminants stand out: aflatoxin inducing primary liver cancer by the alimentary route (see "Aflatoxin and primary liver cancer") and erionite mineral fibres inducing mesothelioma by the respiratory route (see "Erionite mineral fibres and mesothelioma"). These two cases offer examples of ways that may lead to the identification of new environmental carcinogens. For aflatoxin, the evidence of carcinogenicity in animals, from accidental ingestion of contaminated food by poultry and rainbow trout, followed by experiments in rodents, inspired the epidemiological studies in human populations. For erionite, the process went in the other direction: the epidemiological findings prompted the subsequent laboratory experiments in rodents.

ERIONITE MINERAL FIBRES AND MESOTHELIOMA

In the early 1970s, interesting cases of chest diseases were reported from rural villages in Central Anatolia, Turkey. The cases had initially been mistakenly diagnosed as tuberculosis, but a senior Turkish chest physician, well acquainted with asbestos-related diseases, astutely observed that they were pleural mesotheliomas. They appeared to be clustered in some small villages, raising the suspicion that they might have originated from exposure to mineral fibres, either of asbestos or of a similarly acting material. A field investigation, conducted by the Department of Chest Diseases of Hacettepe University, Ankara and IARC, confirmed the peculiar epidemiological situation and identified as the cause a specific natural fibre: erionite, a compound of the zeolite family of minerals, some other members of which are in commercial use as adsorbents of molecules from air or liquids.



A landscape typical of villages like Karain in Cappadocia (central Turkey). Caves are used not only for storage but also, particularly in the past, as homes.

Although a few other villages were affected, a most striking feature was the contrast between two villages 3 kilometres apart: Karain, with a population of 554 in 1978, and Karlik, with a population of 479. The cultural, social, and very poor economic conditions were similar in the two villages. Karlik had poorer general hygiene indicators, such as high infant mortality and house overcrowding; some of the homes were cave dwellings in

the rock, as often seen in postcards from the Cappadocia region. However, adult all-cause mortality was 30% higher in Karain. During the period 1970–1978, 50 cases of pleural mesothelioma were ascertained in Karain, all of whom had died within less than 2 years of diagnosis, irrespective of the treatment. During the same period, no cases were ascertained in Karlik. The 50 deaths in Karain, relative to the size of the village's population in the different age groups, correspond to astonishingly high rates of deaths from mesothelioma; for the age group of 20–30 years, the rate reached the highest rates observed in workers exposed to asbestos.

The appearance of the disease at early ages and the regular, steep increase of the rate with age fit the model of a causal agent to which people are exposed from birth. Indeed, geological studies revealed superficial veins of the mineral erionite in the volcanic rock (tuffs) of Karain; erionite was not present in Karlik. The environmental investigation conducted in parallel with the epidemiological study showed that the majority of fibres in the air from the dusty unpaved streets and the rocky house walls in Karain were erionite. Experimental studies began to follow the reported mesothelioma clusters in humans and rapidly showed erionite to be a potent inducer of mesotheliomas, particularly by inhalation in rats. In 1987, erionite was classified by the IARC Monographs Programme as carcinogenic to humans. The findings encouraged local environmental changes to minimize the release of dust, such as paving the streets, using bricks to construct new dwellings away from the caves, and facilitating the relocation of residents to less polluted areas.

Rates of death from mesothelioma in Karain (1970–1978), for ages 20–69 years. Mesothelioma mortality starts at young ages and rises rapidly with age in both sexes (filled circles, men; open circles, women). The line fits a formal mathematical model of cancer development caused by an agent like erionite to which exposure begins at birth.

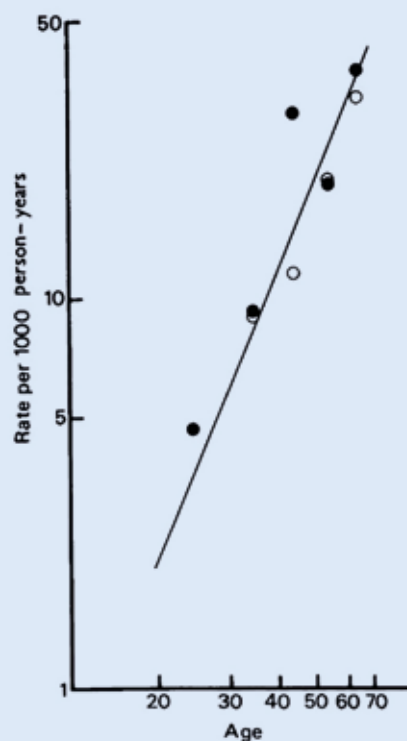

The multicentre model in populations of workers

Workers in mining, agriculture, industry, and services are exposed to a variety of chemicals, physical agents, or microorganisms, usually at levels higher than exposures experienced by the general population. If an increased cancer risk is induced by some of these exposures, it will show up and will be easier to detect among the workers than in the general population. However, the number of workers in a single factory or workplace is often only a few hundred – not enough to reveal an increased cancer risk (unless it is huge). Therefore, combining populations from several workplaces, often remote from each other, becomes imperative. This fits perfectly with IARC's mandate of conducting multicentre international projects, which took form in a series of occupational epidemiology studies that were typical in their design, size, and organization, and in the collaborative sharing of responsibilities between researchers (see "Three multicentre occupational studies").

THREE MULTICENTRE OCCUPATIONAL STUDIES

Several pesticides resist degradation, thus polluting the general environment for decades. The public health relevance of pesticides, old and new, had prompted IARC's early experimental studies on DDT (see "DDT and transplacental and transgenerational carcinogenesis"). A similar concern was at the origin of a cohort study of workers exposed to herbicides extensively used for weed eradication. An overall cohort of more than 20 000 male and female workers employed in the production or spraying of phenoxy herbicides and chlorophenols often contaminated by dioxins was assembled from 36 cohorts in 12 countries. The workers were observed for an average of 25 years. An increased risk of sarcomas, a rare cancer of the soft tissues, was detected in workers who had been exposed to dioxin-based products. Even in this very large cohort, only six cases of sarcoma were recorded (when three were expected); smaller cohorts, as are available within a single country, would have been inadequate to pick up the warning signal. Dioxins have been classified by the IARC Monographs Programme as carcinogenic to humans.

Man-made vitreous fibres are synthetic products that are widely used, mainly as insulation materials, replacing asbestos in a variety of applications. A Europe-wide study was conducted that included 13 plants and provided a cohort of more than 20 000 workers observed for an average of 20 years. Since the substantial production of these fibres began, in the late 1930s, the industrial processes have evolved considerably, and the level of exposure of workers to fibres dispersed in the plant environment is low. In these settings, no warning signals of increased cancer risks have emerged, and in the IARC Monographs man-made vitreous fibres are categorized as Group 3, not classifiable as to their carcinogenicity to humans.

Different types of ionizing radiation have long been known to be carcinogenic and are categorized as such in the IARC Monographs. A major question that is relevant for the protection of workers and the general population (who are exposed through natural sources and medical diagnostic procedures) is the actual size of the risk associated with low-level, protracted exposures. To investigate this issue, a very large cohort of more than 400 000 radiation workers in the nuclear industry in 15 countries was assembled and observed for an average of 12 years, and close to 5000 cancers were recorded. The results were suggestive of a small excess of solid tissue cancers even at low doses with protracted exposure. This study is currently being extended by prolonged observation of the worker population, which should enable a firmer estimate to be made of what appeared initially as a small excess.

Projects often begin with an enquiry made to epidemiologists belonging to the worldwide network of IARC contacts. Their willingness is explored to conduct a preliminary study to find out whether an investigation is feasible in their country. This involves identifying groups of workers exposed in the past to the substances of interest (e.g. herbicides), following them up until the present, recording cases of cancers and causes of death, and documenting the workers' exposures through job histories and environmental measures, past and current.

If the study is shown to be feasible, a working group is formed, including epidemiologists and industrial hygienists, to define the study plan. Usually, prolonged discussions are necessary to produce a genuine

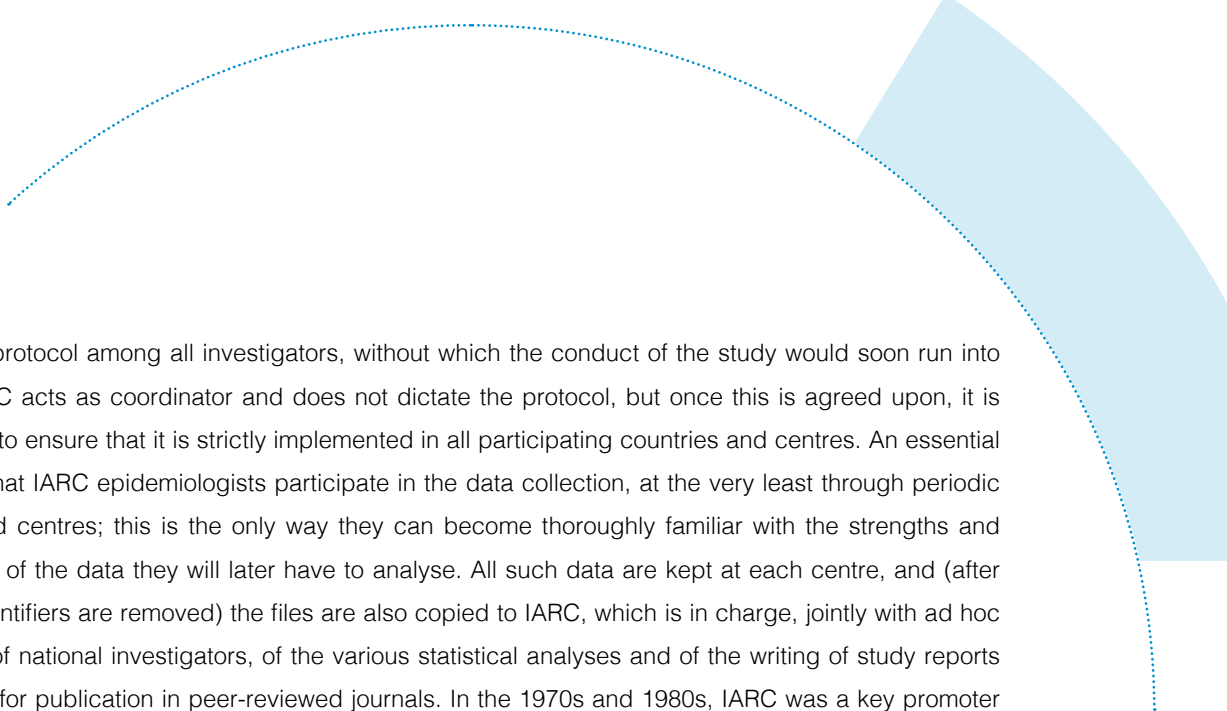

consensus protocol among all investigators, without which the conduct of the study would soon run into trouble. IARC acts as coordinator and does not dictate the protocol, but once this is agreed upon, it is IARC's task to ensure that it is strictly implemented in all participating countries and centres. An essential element is that IARC epidemiologists participate in the data collection, at the very least through periodic stays at field centres; this is the only way they can become thoroughly familiar with the strengths and weaknesses of the data they will later have to analyse. All such data are kept at each centre, and (after personal identifiers are removed) the files are also copied to IARC, which is in charge, jointly with ad hoc subgroups of national investigators, of the various statistical analyses and of the writing of study reports and papers for publication in peer-reviewed journals. In the 1970s and 1980s, IARC was a key promoter of this type of study, in the occupational field and more generally in epidemiology. Many investigators worldwide contributed to the IARC-coordinated projects, acquiring experience with a study model that has since become much more widely adopted, notably within the multinational epidemiological research projects supported by the European Union.

When nearly everyone is exposed

Agents to which all people are exposed more or less uniformly because they are present in the air or water are of great public health relevance, and it is vital to know whether they may induce cancer. However, in many cases the primary evidence that general environmental pollutants – like diesel exhaust – are carcinogenic comes from subgroups exposed at higher levels, typically because of their occupation, as mentioned above. Once such evidence is in, it becomes important to estimate how much of the cancer burden in the total population is in fact attributable to such pollutants. For instance, a study using the IARC European Prospective Investigation into Cancer and Nutrition (EPIC) cohort, recruited in 10 European countries (see the chapter “Nutrition, metabolism, and cancer”), estimated that about one fifth of lung cancers in never-smokers or former smokers could be attributed to involuntary smoking (i.e. exposure to second-hand or environmental tobacco smoke), mostly in the workplace (see “Tobacco and cancer”). One twentieth of the lung cancers in never-smokers or former smokers could be attributed to high levels of air pollution, as judged by nitrogen dioxide levels or proximity to roads with heavy traffic.

Electromagnetic fields, as generated by communication systems or power lines, are today widely present in all environments. In particular, the use of mobile phones has been rapidly expanding, and more than 6 billion are now in use. IARC is a major contributor to generating and evaluating the scientific evidence on the relationship between mobile phones and cancer. IARC coordinated the largest case-control study on brain tumours in adults (the INTERPHONE study) and is involved as a key party in several cohort studies of mobile phone users, still in progress. In addition, at the level of evidence evaluation, a Working Group of the IARC Monographs Programme has assessed radiofrequency electromagnetic fields (see “The IARC classification of carcinogens”).

TOBACCO AND CANCER

In 1964, two landmark documents in the history of tobacco and health were published: the United States Surgeon General's Report *Smoking and Health* and a two-part paper by Richard Doll and Austin Bradford Hill entitled "Mortality in relation to smoking: ten years' observations of British doctors". Unequivocally, tobacco smoking caused cancers at several sites, notably in the lung and upper respiratory airways. How could the newly formed IARC enter a research field where a lot was already known and more knowledge was added every day by a large number of investigators and institutions operating in the field of tobacco and health?

Based on existing knowledge, information on tobacco smoking had become a must in most epidemiological studies, if for no other reason than to rule out that tobacco smoking, rather than other factors of interest (e.g. workplace exposures to asbestos), was responsible for any observed excess of cancers. Thus, information on tobacco smoking was incorporated into IARC studies whenever feasible. Over more than 40 years, this has generated a host of results, notably on the interactions of tobacco with other agents: from the interaction with alcohol in the causation of oesophageal cancer in the studies in north-western France in the 1960s and 1970s (see the chapter "Innovation in statistical methods") to the recent and current lung cancer studies focused on identifying genetic variants that may enhance or reduce individual susceptibility to developing a tobacco-induced cancer (see the chapter "From laboratory to population").

There were also aspects of tobacco smoking that were less well understood, and IARC selectively concentrated on some of these. A multicentre case-control study of cancer of the larynx and hypopharynx in southern European countries clearly showed a 2-fold higher risk from the use of black, air-cured tobacco than from blond, flue-cured tobacco. In parallel, studies at IARC laboratories examining urine samples for substances capable of inducing DNA mutations clearly showed that the urine of smokers of black tobacco contained twice as much of these substances as the urine of smokers of blond tobacco. This result pointed to the role of black tobacco in the causation of bladder cancer, which was twice as frequent among smokers of black tobacco as among smokers of blond tobacco. Years later, when the issue of the effects of involuntary smoking (exposure to second-hand smoke) was raised and several small to moderately sized studies were published, IARC conducted a large study in seven countries of the risk of lung cancer in never-smokers exposed to second-hand smoke. The study included 650 cases and 1200 controls and showed that people exposed to second-hand tobacco smoke at home and in the workplace experience on average a 20% increase in the risk of lung cancer, with a higher increase for higher accumulated exposures over the years.

IARC's role in providing an international reference for carcinogenic risks prompted a series of timely activities and publications centred on tobacco and cancer. By the mid-1980s, the first clear signs appeared that a major epidemic of tobacco-induced cancers was looming in developing countries. David Zaridze, currently at the Cancer Research Centre in Moscow and then an IARC staff member, took the initiative of organizing a conference of top international scientists in Moscow. The urgency of the message emerging from the conference

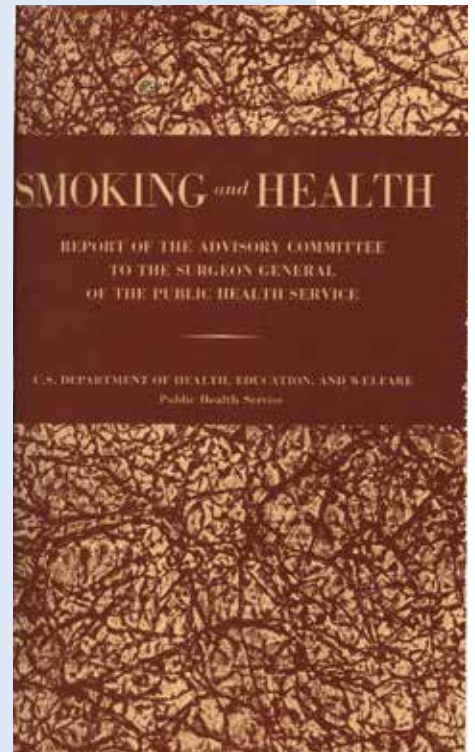

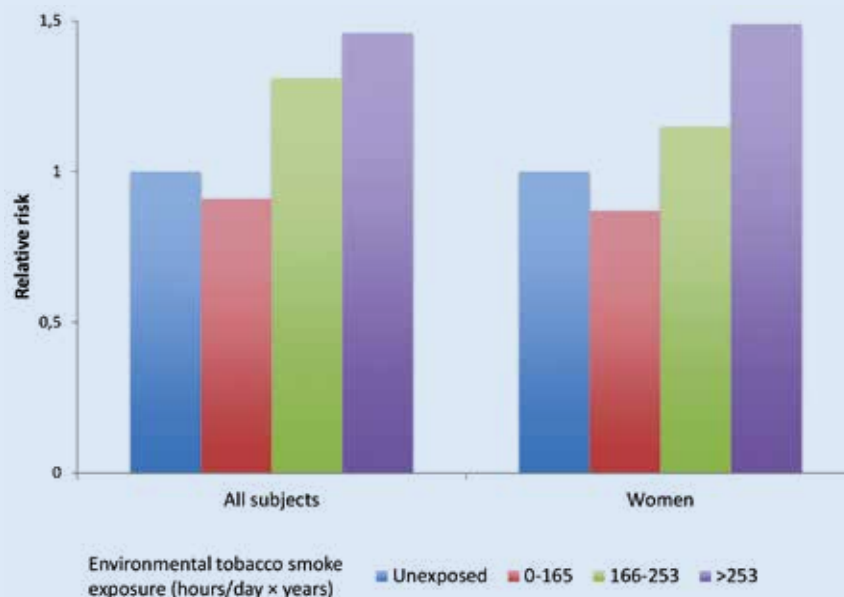

In the multicentre environmental tobacco smoke study, coordinated in Europe by IARC, the risk of lung cancer in non-smokers increases in both men and women with increasing exposure to environmental tobacco smoke; duration of exposure is measured cumulatively as hours per day multiplied by years of exposure.

is expressed in the title of the proceedings: *Tobacco: A Major International Health Hazard*, published by IARC in 1986. It contained a concise set of tobacco control recommendations, including the reduction of the tar content of cigarettes. Although at variance with the general principle of “no smoking” of any type of tobacco, this was a realistic recommendation for countries like those in eastern Europe, where the tar content of cigarettes was still very high. Zaridze believes that the recommendations proved highly influential in the Russian Federation, and more generally in eastern Europe, and “saved hundreds of thousands of lives of people who would otherwise have died of lung cancer.”

Volume 83 of the IARC Monographs, *Tobacco Smoke and Involuntary Smoking*, was published in 2004. This massive volume (with more than 1400 pages) updated the evidence on tobacco smoke, to now be regarded as capable of increasing the risk not only of lung cancer but also of cancers at other body sites (14 in all) such as the upper respiratory airways, mouth, pancreas, and bladder. The volume was especially timely to settle the case of involuntary smoking: based on the evidence of more than 50 epidemiological studies, “There is *sufficient evidence* that involuntary smoking (exposure to second-hand or ‘environmental’ tobacco smoke) causes lung cancer in humans.”

Finally, IARC tackled the complex issues bearing on the effectiveness of the great variety of measures hitherto implemented for tobacco control. The review of legislative documents for tobacco control in the European Union countries, coordinated in the 1990s by Annie Sasco, was a first step in this direction. A broader, systematic approach was later developed: from 2006 to 2010, four Working Groups were convened and four volumes published in the IARC Handbooks of Cancer Prevention series, which mirrors (with necessary adaptations) for preventive interventions the procedures, criteria, and format of the IARC Monographs for risk evaluation.

For people who stop smoking cigarettes, the percentage survival increases markedly compared with those who continue smoking. The earlier the age of stopping, the closer the survival curve for those who stop (dashed curve) approaches the curve for lifetime non-smokers. However, even stopping at age 55–64 years is beneficial, as the dashed curve for those who stop at this age still shows better survival than the solid curve for cigarette smokers.

Effect of stopping smoking at age -30 on survival from age 35

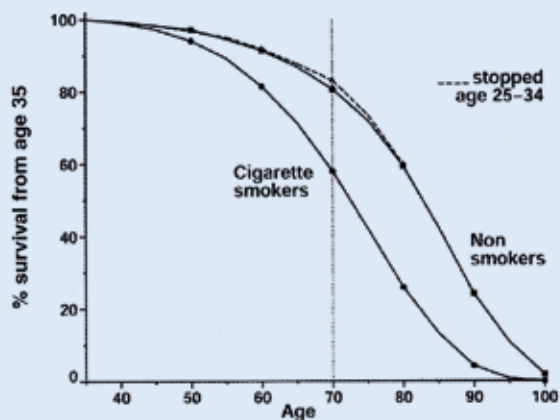

Effect of stopping smoking at age -40 on survival from age 40

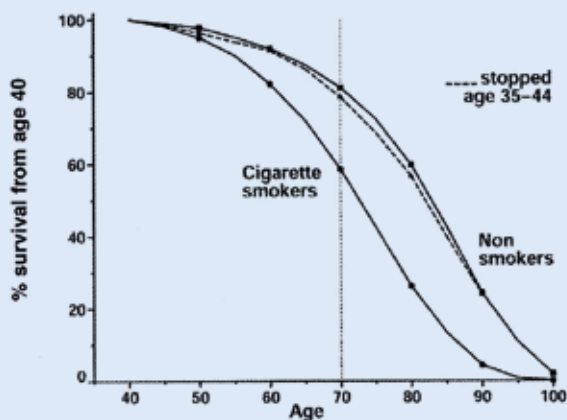

Effect of stopping smoking at age -50 on survival from age 50

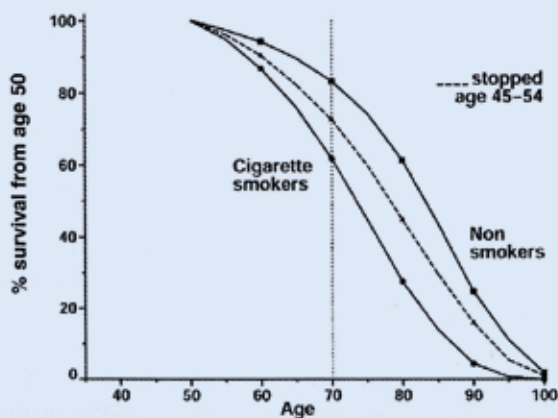

Effect of stopping smoking at age -60 on survival from age 60

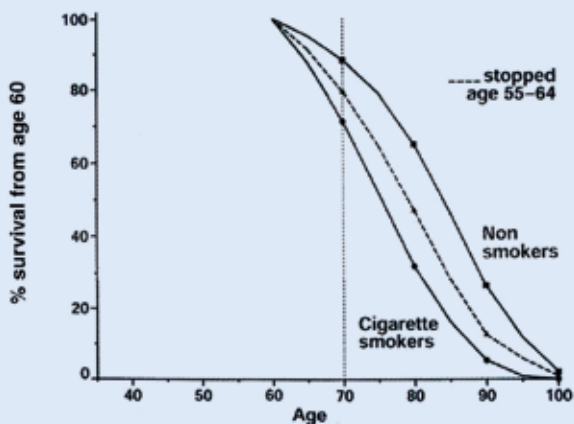

The first tobacco control Handbook, *Reversal of Risk After Quitting Smoking* (published in 2007), was dedicated to Richard Doll, who had died in 2005. In 2003, Doll's 50-year follow-up of "his" cohort of British doctors had shown that about half of all smokers are eventually killed by smoking, that on average smokers lose about 10 years of life expectancy, and that those who have smoked cigarettes since early adult life but stop at age 60, 50, 40, or 30 years gain, respectively, about 3, 6, 9, or almost the full 10 years of life expectancy, compared with those who continue smoking.

The second tobacco control Handbook, *Methods for Evaluating Tobacco Control Policies*, addressed methods and provided a framework for guiding the evaluation of tobacco control policies, including smoke-free environments, limits on marketing, product labelling, and taxation. The third and fourth volumes more specifically covered the evaluation of the effectiveness of smoke-free policies and of the effectiveness of tax and price policies for tobacco control.

Tobacco use remains the leading preventable cause of premature death worldwide, and two thirds of tobacco-related deaths occur in developing countries. Unfortunately for human health, the scourge of tobacco use will not disappear overnight. Tobacco and cancer will continue to be a prominent topic for IARC as a research institution in the service of public health within the framework of WHO. IARC's work and publications provided the sound scientific basis for the WHO Framework Convention on Tobacco Control. The Convention is an international evidence-based treaty that entered into force in 2005 for the worldwide control of the supply and demand of tobacco products via a series of derived regulations and interventions.



The IARC Handbooks of Cancer Prevention programme was launched in 1995 under the coordination of Harri Vainio, who was then responsible for the IARC Monographs Programme. Vainio (left) is seen shaking hands with Nikolai Napalkov, a long-term IARC collaborator who was director of the N.N. Petrov Institute of Oncology in St Petersburg and subsequently Assistant Director-General of the World Health Organization. The first 10 Handbooks covered several potentially preventive measures, including the use of chemopreventive agents like non-steroidal anti-inflammatory drugs, the consumption of fruit and vegetables, and the use of sunscreens. Handbooks 11–14 were devoted to tobacco control. The programme gained fresh impetus in 2014 with a reassessment of breast cancer screening (see the chapter “Cancer screening and early diagnosis”).



A photograph of a man with a beard and a woman in a rural setting, overlaid with a blue circular graphic. The man is standing on the right, wearing a dark jacket over a striped shirt. The woman is on the left, wearing a white headscarf and a light-colored jacket. They are in front of a large, round, thatched structure, possibly a traditional oven or a storage container. The background is a bright, open landscape. The entire image is overlaid with a semi-transparent blue circular graphic that has a dotted white line around its perimeter and a thick white line forming a partial circle in the center.

NUTRITION, METABOLISM, AND CANCER

NUTRITION, METABOLISM, AND CANCER

“Individuals who overeat and are overweight when past middle age are more likely to die of cancer than persons of average weight or less. ... It seems reasonable to expect that the avoidance of overweight would result in the *prevention* of a considerable number of cancers in man. ... Even moderate continued caloric restriction or control of body weight deters the development of neoplasms.” The date of this text is startling: 1953. In the first volume of *Advances in Cancer Research*, published that year, Albert Tannenbaum and Herbert Silverstone contributed a review entitled “Nutrition in relation to cancer”. It reported results from

six studies using data on cancer mortality and body weight from insurance companies in the USA, and one questionnaire-based survey of dietary habits. More fundamentally, it presented the findings of the pioneering experimental studies conducted in the 1940s and 1950s in Tannenbaum’s laboratory, which clearly showed that a restriction in caloric intake induced a sizeable decrease in the incidence of tumours in mice compared with an “eat as you wish” (ad libitum) diet. The reduction occurred both for cancers arising spontaneously in mice and for cancers induced by exposure to known carcinogenic chemicals. The scene was set to confirm these results in human populations using more accurate measurements, particularly of dietary assessment, and – much more challenging – to try and understand how caloric intake may influence cancer occurrence in different organs in humans.

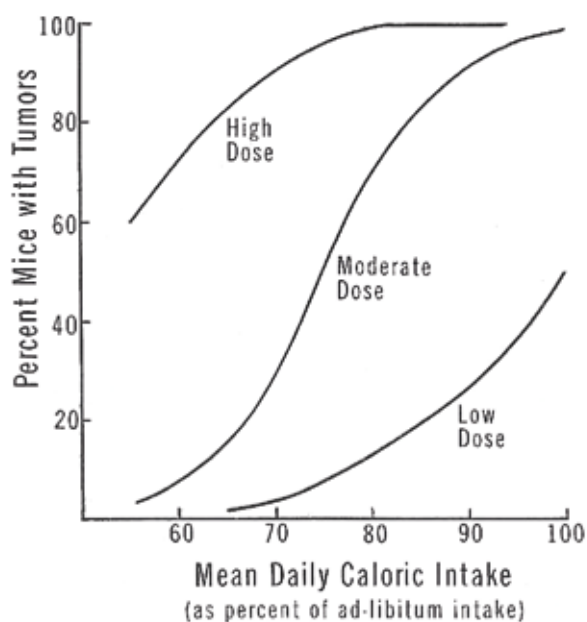

Idealized relationship between degree of caloric restriction and tumour incidence: curves that can be obtained with low, moderate, or high doses of carcinogenic chemicals.

STEPPING UP THE EPIDEMIOLOGY OF NUTRITION AND CANCER

Diet is an obvious possible cause of digestive cancers, particularly those that exhibit wide variation in occurrence

between populations. One example is oesophageal cancer. In the high-incidence areas of Brittany, rates are elevated mostly among men, and an early IARC study clearly indicated tobacco smoking and alcohol consumption as causal agents (see the chapter “Innovation in statistical methods”). Dietary factors, also explored in the studies in Brittany and Normandy, suggested a protective effect of citrus fruits, possibly related to their vitamin C content.

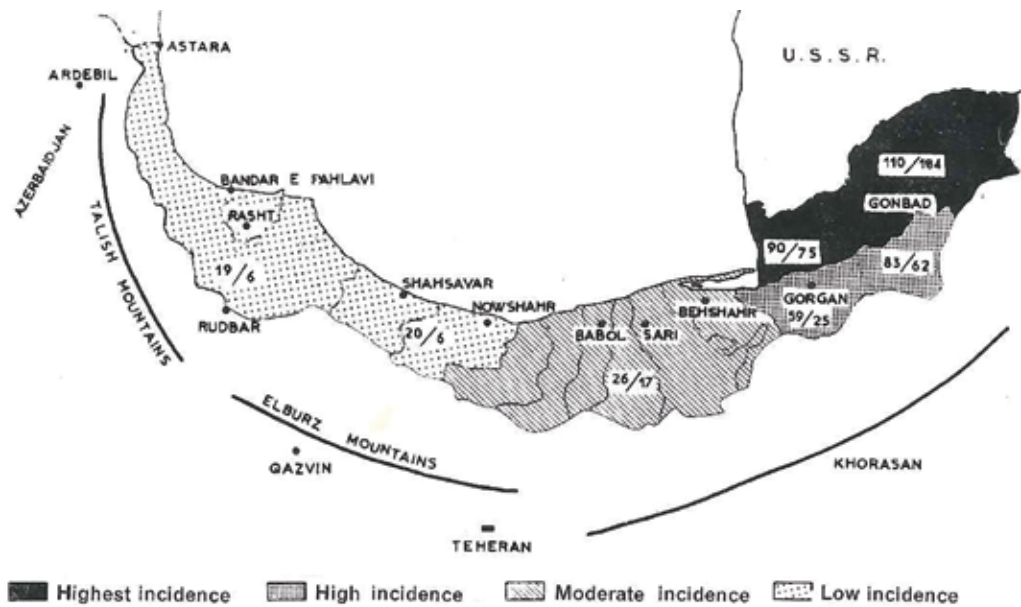

Incidence of oesophageal cancer in the Caspian littoral region of the Islamic Republic of Iran (1970). Numbers indicate rates per 100 000 people per year (males/females).

Unlike in Brittany and Normandy, a high occurrence of oesophageal cancer was reported for both men and women in the Caspian littoral region of the Islamic Republic of Iran, bounded to the south-west by the Elburz Mountains. To firmly document the reports, a population-based cancer registry was established in 1969 as a joint endeavour of Tehran University and IARC (see “The IARC diaspora” in the chapter “The birth of IARC”). The registry confirmed the high incidence of oesophageal cancer in the eastern part of the littoral, the area now known as Golestan Province, and particularly in northern Gonbad, a semidesert plain inhabited mainly by people of Turkmen ethnicity, where incidence was much higher in women than in men. Rates



Some inhabitants of the rural area in the Islamic Republic of Iran where the incidence of oesophageal cancer is high.



declined steadily towards the west, and 300 kilometres from Golestan they were one tenth as high, with a preponderance of cases in men.

To address the causes of this striking pattern of occurrence, several IARC collaborative studies were conducted in the 1970s. They pointed to different possible factors, in particular low socioeconomic status, thermal injury from consumption of very hot tea, and exposure to carcinogens in combustion products, including from opium use. However, none of these could be soundly established as causes. After a quiescent phase of two decades, a new cycle of investigation started in the 21st century. A key component is the Golestan Cohort Study, a prospective study of oesophageal cancer conducted by IARC in collaboration with Tehran University and the United States National Cancer Institute (see “Back into action: the Golestan Cohort Study”).

Collecting information about diet on one or more occasions and then relating it to the subsequent occurrence of cancer, as is done in prospective cohort studies (like the Golestan Cohort Study), is much preferable to collecting dietary information in cancer cases and non-cancer controls, as is done in case-control studies, because it is less prone to biases and errors. People with cancer have often altered their diet because of the disease and may be very inaccurate in reporting what they were eating at earlier times, except for items that can be distinctly remembered, like alcohol consumption. However, prospective studies are much more difficult and lengthy than case-control studies. A large population needs to be assembled and dietary information collected for each person, so that an adequate number of cancer cases can be obtained – usually after at least 10 years – to explore the relationship between dietary items and cancer occurrence. A welcome opportunity to “warm up” for the task of embarking on prospective dietary studies came to IARC from an interested group of investigators in the city of Malmö, Sweden, where a pilot investigation was conducted collaboratively and demonstrated the feasibility of using complex dietary assessment methods (see “How good are dietary measurements?”).

THE EUROPEAN PROSPECTIVE INVESTIGATION INTO CANCER AND NUTRITION

Beginnings

By the early 1980s, the scientific community had realized that convincing answers to diet-cancer hypotheses could be obtained only by investing in large population-based prospective cohort studies. The Harvard School of Public Health had started the Nurses' Health Study in 1976 and expanded it in the 1980s. In Europe, an excellent opportunity arose for IARC through the Europe Against Cancer programme, established in 1985 by the European Community. Within this programme, diet was earmarked as a key priority, provided that the research would involve a substantial number of European countries. This would mean mounting one very large project, organized in several countries, with coordinated and standardized protocols.

BACK INTO ACTION: THE GOLESTAN COHORT STUDY

The Golestan Cohort Study was launched in January 2004, a contemporary and technically advanced successor to the early IARC projects of the 1960s and 1970s. It has three primary aims.

The first aim is to identify risk factors for oesophageal cancer in a population with a high frequency of the disease, by a comprehensive assessment of personal characteristics, work and medical history, physical activity, body measurements, tobacco use, alcohol consumption, and opium use. Particular attention is given to diet, which is evaluated through a food questionnaire specially developed for use in this population. The questionnaire covers the consumption of more than 100 items, including bread and cereals, meat and dairy products, oils, confectionery, legumes, vegetables, fruits, and condiments, as well as cooking methods.

The second aim is to take advantage of IARC's experience in biobanking to establish a local or national repository for long-term storage of blood, urine, hair, and nail specimens to be used in molecular biology and genetic studies. Half of the frozen blood samples have been sent to Lyon for storage in the IARC Biobank.

The third aim is to provide a model for population-based studies in areas and countries in economic and social transition, based on collaborations between international institutions like IARC and local and national health workers, authorities, and research centres.

The project has progressed successfully, with Iranian investigators making a leading contribution. The plan involved the enrolment into the cohort of 50 000 people aged 45–75 years, 20% from urban areas (in the city of Gonbad) and 80% from rural areas, with equal numbers of men and women. The target number of participants was reached in 2008, and people are now actively followed up through annual telephone calls by local health workers and through a review of monthly death registration data to record causes of death and cases of cancer.

The full value of any prospective cohort study emerges only after many years of follow-up, when enough cancer cases have been recorded. However, the Golestan Cohort Study is already generating useful information, in particular on possible early biological markers of oesophageal cancer and on the determining factors of gastro-oesophageal reflux, which is today a common cause of discomfort not only in the Islamic Republic of Iran but worldwide, and in turn a potential cause of one type of oesophageal cancer.

The tower in the central part of the city of Gonbad-e Qabus in the Islamic Republic of Iran has been a UNESCO World Heritage Site since 2012. The 72-metre brick tower, built in 1006, is a decagonal building with a conic roof. Gonbad houses the Golestan Cohort Study Center, a research centre established specifically for the project.



HOW GOOD ARE DIETARY MEASUREMENTS?

In case-control studies, dietary assessment in cases may be distorted by changes in diet (or in the recollection of diet by the patient) due to the presence of the cancer, but even in healthy people dietary measurements are challenging and potentially subject to errors. Many meals vary in composition from day to day. An individual's diet may also undergo more general changes, in food types and quantity, over the long term because of ageing or changing personal circumstances, such as living alone or in a family.

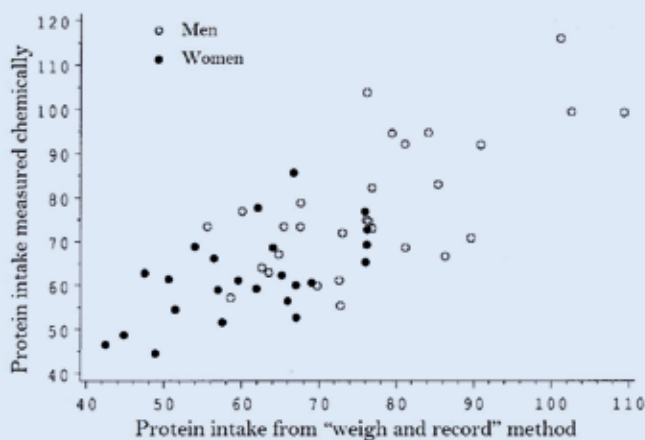

Results from the Malmö food study. The mean daily intake of protein determined chemically from nitrogen output in samples of urine is plotted against the mean daily intake of protein estimated by means of food tables from the "weigh and record" method.

Other than in experimental and rigidly controlled conditions (as in laboratory studies of metabolism), there is no perfect method to measure what a person has eaten and drunk over a prolonged period. Methods that weigh and record all foods and beverages seem an optimal solution, but they are cumbersome and not applicable on a large scale. In the pilot study in Malmö, which involved 500 people, six 3-day periods of weighing and recording, supervised by a dietician, were evenly distributed over a 1-year period. These records, faithfully capturing what had been eaten and drunk during each of the 18 days, were considered to be representative of that person's typical diet.

Indeed, as the graph shows, for a nutrient like protein there is good agreement between the estimates of intake derived by the "weigh and record" method and the actual intake measured chemically. It was therefore reasonable to regard the results from the "weigh and record" method as the yardstick or reference against which to evaluate the validity of methods that are more practicable on the large scale, as are needed in a cohort study involving thousands of participants. Two such methods were tested. First, an extensive questionnaire, with the help of pictures of food portion sizes, was used to gather information on the frequency of consumption of more than 300 foods over the preceding 12 months. Second, a reduced questionnaire, involving only 130 foods, was used, supplemented by recording (but not weighing) all foods and beverages consumed over a 2-week period. Both methods provided satisfactory agreement with the reference method.

A further degree of complexity is inherent in any dietary study because the research questions concern not only what people eat and drink but also the specific nutrients, like proteins, sugars, fats, vitamins, and alcohol, contained in foods and beverages. Therefore, after a dietary assessment is performed, the intakes need to be converted into amounts of nutrients. This can be done using published conversion tables. These food tables indicate the amounts of nutrients present in each of a long list of typical foods and beverages, as actually measured by methods of analytical chemistry. However, food tables may be incomplete or out of date, or may not even have been developed for the foods commonly consumed in some countries. In fact, when the European Prospective Investigation into Cancer and Nutrition (EPIC) project began, the first step was to develop appropriate food conversion tables. IARC coordinated and assisted in this complex exercise of validating methods in each of the participating countries, including assembling the pertinent food tables and working towards their harmonization.

Establishing such a project was a major challenge, including all methods and procedures, from the recruitment of subjects and the design of questionnaires for collecting data on diet and many behavioural factors to the collection of biological samples and the controversial inclusion of anthropometric measurements. Moreover, the protocols established had to be as similar as possible, while maintaining adaptability to the languages and cultures of the different European countries. For most investigators, at IARC as well as in the individual countries, this was a novel experience that required a full, long-term commitment.



Elio Riboli led the conception and development of the European Prospective Investigation into Cancer and Nutrition (EPIC) project and the EPIC biobank. In 2005, after 20 years at IARC, he moved to Imperial College London as a professor of cancer epidemiology; he became director of the School of Public Health there when it was established in 2010.



Map showing the location of all EPIC collaborating centres, including the joint coordinating centres: IARC, in Lyon, and Imperial College London (ICL).

The project was also a new direction within IARC's overall research strategy. In the words of Elio Riboli, "At IARC, research on the causes of cancer had historically focused on chemical, physical, and biological carcinogens, and since its creation IARC has made major contributions to the identification of exogenous carcinogens. This makes even more innovative and forward-looking the leading role that IARC has played in the investigation of the role of nutritional, metabolic, and – more generally – endogenous host factors in cancer etiology. IARC was one of the first top-level research centres to establish a Nutrition, Hormones, and Cancer Programme, in the early 1980s, which led to the establishment of the largest nutrition- and metabolism-focused prospective cohort study with a biorepository of the 20th century. These achievements were made possible by the international standing of the institution, its visionary leadership, the dedication of its staff, and its ability to develop an extensive network of long-term collaborators."

The planning and piloting of the project that soon became known as the European Prospective Investigation into Cancer and Nutrition (EPIC) started with a series of methodological and feasibility studies. They included, in particular, testing the validity of dietary questionnaires within each country, along the same lines as the investigation previously carried out in Malmö, and developing the procedures for collecting and storing biological samples for the associated biorepository. These pilot studies provided very encouraging results, which supported the European Community's decision in 1992 to fund EPIC jointly with several national granting organizations. Recruitment of study participants and collection of data and biological samples started in 1993 in four countries (France, Italy, Spain, and the United Kingdom) and was extended between 1994 and 1998 to include six further countries (Germany, Greece, and the Netherlands and the three Scandinavian countries, Denmark, Norway, and Sweden, which adopted their own procedures for the storage of biological samples). Enrolment was completed in 1999, when the cohort included more than half a million people in 23 EPIC centres in the 10 participating countries.

MEASURING FOODS AND NUTRIENTS IN AN INTERNATIONAL CONTEXT

Assessing diet in a variety of populations poses a major methodological challenge. The diet of EPIC participants was assessed by different instruments that had been developed and validated previously in local methodological studies. The results of these studies, together with the need for a “flexible uniformity”, guided the choice of measurement methods. These methods needed to be as uniform as possible across centres, to allow results in different cohorts to be compared. At the same time, they needed to be flexibly adapted to local circumstances. For instance, in some places participants could easily complete a dietary questionnaire by themselves, while in others an interview appeared to be preferable. A major source of local variability is, of course, diet itself: foods and dishes that are eaten frequently in some places may seldom or never be eaten in other places. The questionnaires had to be suitable for use under these variable circumstances.

Three dietary assessment methods were eventually adopted. The first was *quantitative dietary questionnaires* containing up to 260 food items and systematically estimating individual average portions. They were used in six countries (France, Germany, Greece, Italy, the Netherlands, and Spain). To improve the reliability of the acquired information, centres in two countries (Italy and Spain) performed a face-to-face dietary interview using a computerized dietary program. The second method was *semiquantitative food frequency questionnaires*, in which a list of food items was compiled for each participant and the same fixed portion size for each food item was assigned to all participants. These were used in three countries (Denmark, Norway, and Sweden). Third, *combined dietary methods* were used in the United Kingdom and in Malmö (Sweden), following the principle of the method developed in Malmö, which combined a questionnaire on the frequency of food consumption with a detailed record of diet for a fixed number of days.

Agreeing on just three methods for 23 centres went a long way towards uniformity, but the issue remained of ensuring that these methods were comparable. To this end, additional dietary measurements were collected through a newly developed instrument of recall of diet over a 24-hour period (EPIC-Soft) in representative subsamples of 8% of participants in each cohort (see “Novel instruments for studies of diet worldwide”). In total, as many as 37 000 EPIC-Soft measurements were collected from EPIC participants. These were used as a reference to align on a common scale the food and nutrient estimates obtained by the three different methods in the 23 centres. Within EPIC, the estimates of amounts of several nutrients, like proteins, lipids, sugars, and vitamins, were derived from the food consumption data by using a conversion table that provides the amount of each nutrient present in each gram of each food. A specific project, the European Nutrient Database (ENDB), was required to develop a common conversion table – in fact, a common food composition database – standardized across the 10 participating European countries.

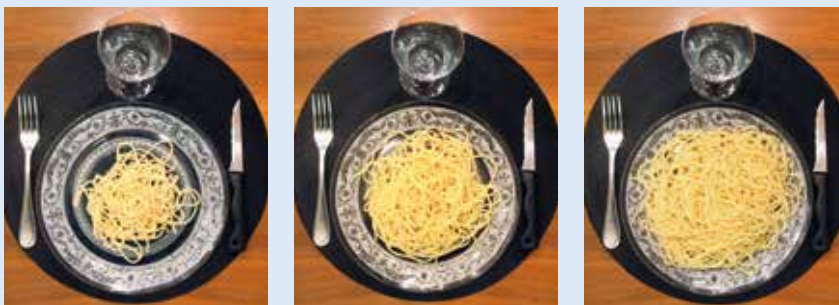

Examples of photographs of different portion sizes, used to support the quantification of consumed foods.

NOVEL INSTRUMENTS FOR STUDIES OF DIET WORLDWIDE

EPIC-Soft, recently renamed GloboDiet, is a computerized tool for detailed recall of all items a person has eaten and drunk during the previous 24 hours. This interview-based dietary assessment instrument has been successfully used and has been shown to increase the accuracy of dietary data measurements in international settings. It was developed and is maintained by IARC. It was first used within the EPIC study, for which it was initially designed, and is currently in use or planned to be used in several different national and international studies in Europe. Today, GloboDiet is the only available software package that has been constructed to provide standardized individual food consumption data for adults in different European populations. GloboDiet enables the description and quantification of all items consumed, selected from 1500–3000 foods and 150–450 recipe ingredients specific to each country. The software automatically codes food items and recipe ingredients and calculates nutrient intake. This results in an extremely detailed description of the type and amount of all items that have been eaten or drunk by a person during the previous 24 hours.

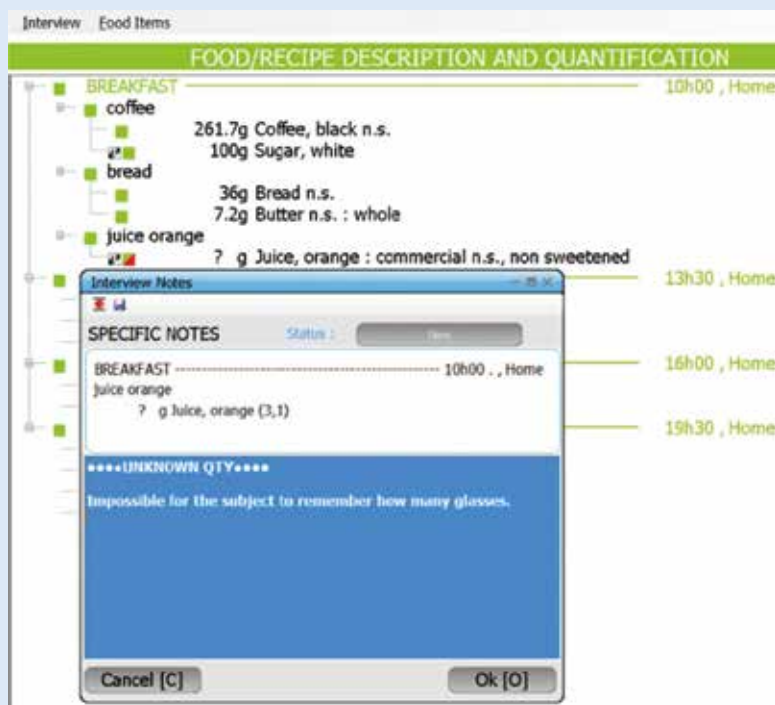

An example of a note file generated during a GloboDiet interview.

GloboDiet has been used in several projects, in particular in the European Food Consumption Survey Methods (EFCOSUM) Project and the European Food Consumption Validation (ECOVAL) Project. An adaptation for food records in children has been positively evaluated within the Pilot Study for the Assessment of Nutrient Intake and Food Consumption Among Kids in Europe (PANCAKE) Project. Like the European Nutrient Database, development of the GloboDiet methodology was prompted by the needs of the EPIC study. Both of these tools have enabled far wider progress in epidemiological investigations of diet and disease and in surveys monitoring the evolution of dietary habits across populations worldwide. GloboDiet is now a key instrument of a joint IARC-World Health Organization Global Nutrition Surveillance initiative aimed at improving nutritional surveillance for the control of noncommunicable diseases.

An extensive data collection

At each EPIC collaborating centre, detailed information was collected on each participant with respect to diet, anthropometric measurements (weight, height, waist and hip circumference), medical history, and a spectrum of lifestyle habits (see “Measuring foods and nutrients in an international context”). This included items related to education and socioeconomic status; current job, and current and past occupations, which might have led to exposure to carcinogens; history of previous illnesses, disorders, or surgical operations; lifetime history of tobacco smoking; lifetime history of alcohol consumption; physical activity (occupational, walking, cycling, gardening, housework, physical exercise, climbing stairs); menstrual and reproductive history; and use of exogenous hormones for contraception and postmenopausal hormone replacement therapy. At most EPIC centres, blood pressure was also measured at recruitment. Biological samples including plasma, serum, white blood cells, and red blood cells were collected at recruitment from about 400 000 participants. A unique feature was the “split sample” storage of biological samples, at IARC and at the EPIC centres (see “The EPIC repository of biological samples”).

“ EPIC was – and still is – among the biggest international studies available. It was a very ambitious programme, and it started at IARC at a time when these types of big projects were not as common, so this is what makes it very special.
– Manolis Kogevinas, former IARC scientist



Waist circumference, an indicator of fat distribution within the body, is one of the anthropometric variables measured in EPIC study participants.

THE EPIC REPOSITORY OF BIOLOGICAL SAMPLES

A key resource of the EPIC project is the availability of blood samples taken from participants at the time of recruitment into the cohort. For each participant, blood plasma, blood serum, white blood cells (containing DNA), and red blood cells were collected for long-term storage. The storage procedure differed between the three Scandinavian countries and the other seven participating countries (France, Germany, Greece, Italy, the Netherlands, Spain, and the United Kingdom).

For the seven countries, IARC designed, tested, and developed a novel storage system, which was capable of satisfying the requirements of optimal storage conditions and of dividing samples into small aliquots (so that when a sample is analysed for a specific research question, only a small aliquot is consumed). Each sample was aliquoted into 28 plastic straws containing 0.5 millilitres each. To ensure a high degree of standardization, the materials (syringes, straws, etc.) were purchased by IARC and distributed to the centres. Each sample was then split into two identical sets of 14 aliquots each. One set was stored locally and one was sent to IARC to be stored in a central biorepository in liquid nitrogen at $-196\text{ }^{\circ}\text{C}$, an optimal freezing temperature for inhibiting reactions of biochemical decay. A very similar approach was followed in Norway, whereas in Denmark and Sweden blood samples were stored in 2-millilitre tubes and kept only in local repositories (since the containers at IARC were unsuitable for storage of tubes). In Denmark the samples are stored at $-150\text{ }^{\circ}\text{C}$ in nitrogen vapour, and in Sweden they are kept at $-70\text{ }^{\circ}\text{C}$ in freezers.

When it was established, the EPIC storage system housed a combined total of nearly 9 million aliquots, centrally at IARC and at national facilities, constituting one of the largest collections in the world for biochemical and genetic investigations of cancer and other chronic diseases. Since then, more than 10% of these aliquots have been used for research projects.



The complex structure of the central IARC biorepository. Plastic straws have proven well suited for storing blood in the EPIC project. Each straw is labelled with the participant's identification code and is colour-coded to indicate its contents: red for plasma, yellow for serum, blue for white blood cells, and green for red blood cells. Their tiny size enables storage of small quantities of fluid (0.5 millilitres), and the plastic material permits sealing with an automatic device once a straw is filled. All the straws containing samples from the same participant are stored together in a coloured visotube. The visotubes are placed inside a goblet (each goblet contains 14 visotubes), which in turn is stored in a canister. Canisters are arranged in concentric circles inside each of 33 liquid nitrogen containers. When a sample needs to be retrieved, a software package indicates the sample's container, canister, goblet, and visotube.

The challenge of following up more than half a million people

In the mid-1990s, regular follow-up of EPIC study participants began, to ascertain whether a participant was alive and whether he or she had been diagnosed with any kind of cancer. Additional follow-up to measure changes in lifestyle, health conditions, diagnosed diseases, and related treatment was conducted a few years after recruitment, at least once in all EPIC study centres. The number of cancers developing in the cohort by 2016 is estimated to be more than 96 000. This large number of incident cancer cases with prospectively collected lifestyle data and blood specimens enables EPIC to address state-of-the-art scientific hypotheses about the etiology and prevention of several forms of both common and rare cancers with a high degree of precision and confidence.

Sex-specific expected frequency of major cancer sites in the EPIC cohort by 2016

Sex	Site					
	Breast	Colorectum	Lung	Prostate	Stomach	All cancers
Men	50	4907	4152	10 771	1198	32 334
Women	24 899	7669	3852	0	1010	64 242
Total	24 949	12 576	8004	10 771	2208	96 576

A RICH AND EXPANDING HARVEST OF SCIENTIFIC RESULTS

Early results

EPIC started to produce results as soon as recruitment of the cohort was completed in 1999. The first published reports provided a full picture of the populations of the 10 countries included in the cohort. Physical traits (e.g. weight, height), physical activity, and lifestyle habits like tobacco smoking and alcohol consumption were seen to vary within and between countries. These observed variations underscore the rationale for the initial selection of European regions from north to south and from east to west, aimed at capitalizing on the variability in diet and lifestyle to maximize the power of the study to identify relationships with cancer risk. For instance, large differences in alcohol consumption were found between countries: total alcohol consumption ranged from 3–4 grams per day among women in Greece to about 20 grams per day among women in Denmark and about 40 grams per day among men in Spain. Of particular importance were the differences in food consumption and dietary patterns, notably between the southern European countries and those in central and northern Europe. These differences were described with greater accuracy than in any previously available study. These initial results from EPIC raised the standard of investigation and contributed to a better knowledge of personal and nutritional characteristics relevant to health in 10 European populations.

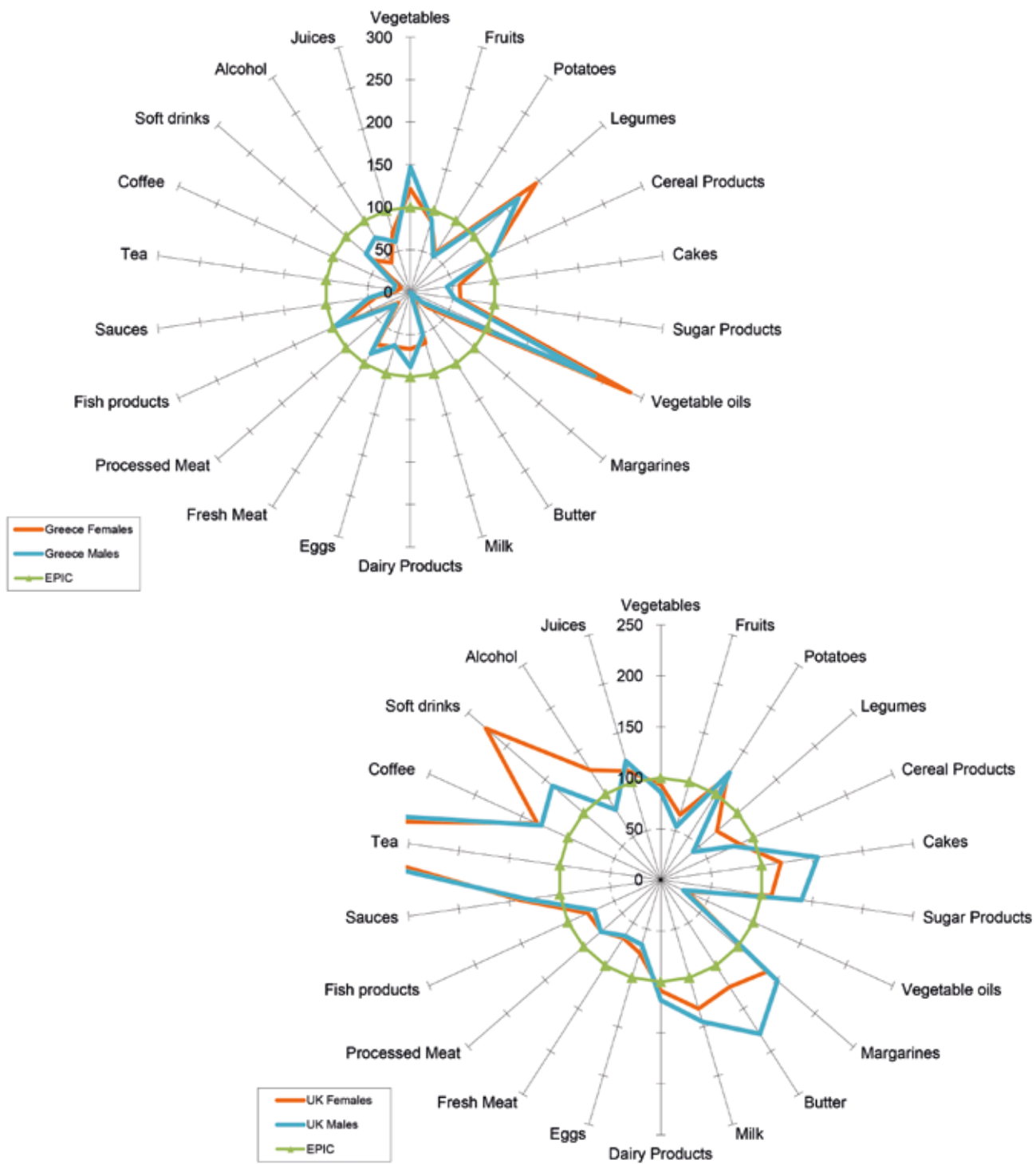

A multidimensional comparison of dietary patterns from the EPIC study. The average consumption for a country of each of 22 foods is expressed as a percentage of the average for all countries, indicated by the green reference circle of radius 100%. A point inside the green circle indicates that people in the country eat less of that food than the all-country average, and a point outside the circle that they eat more. Joining the 22 points generates a "dietary profile" for a country that provides a visual representation of the difference in dietary habits between different countries. For example, the profile for Greece shows "spikes" of high consumption of vegetable oils, legumes, and vegetables, whereas the profile for the United Kingdom shows a very high consumption of tea together with an above-average consumption of butter, margarines, and soft drinks.

Follow-up results

Studies of specific cancers started when a sufficient number of cases of a particular cancer had accrued. These studies were, and are, conducted by international and multidisciplinary Working Groups, each focusing on a topic to be investigated (e.g. breast cancer in relation to consumption of fats, or colon cancer in relation to fibre consumption). Working Groups have a variable composition of members, depending on the interest that individual researchers have in participating in a group, and are coordinated and led by any of the researchers actively involved in EPIC at IARC or in the collaborating countries. Investigators not belonging to the EPIC network are often included in Working Groups, especially when they contribute particular types of expertise.

Two main types of studies are implemented. The first type is for investigations that require only the use of data collected through questionnaires (as is the case for diet, lifestyle habits, or physical exercise) or anthropometric measurements (like weight and height). These analyses are performed on the whole cohort of more than half a million people, with subanalyses by centre, country, sex, and so forth. The second type of study is for investigations that require measurements on blood samples, such as determining plasma concentrations of vitamins or genotyping genetic variants in DNA from white blood cells. In these studies, the laboratory measurements are compared between cancer cases and a random sample of subjects in the cohort. This type of design is known as a case–control study nested within a cohort study. It provides essentially the same information as a study on the entire cohort of more than half a million people, while enabling conservative use of precious blood specimens, of which only a few hundreds or thousands need to be analysed in the laboratory.

The EPIC infrastructure has produced almost 1000 peer-reviewed publications (see epic.iarc.fr), and EPIC studies have received nearly 30 000 citations in the scientific literature. The results from EPIC steadily add to the evidence – still incomplete – on the role of nutritional, metabolic, and genetic factors in cancer development. The relevance of nutritional factors for cancer development is supported by several specific results. (For more on metabolic and genetic factors, see the chapter “From laboratory to population”.)

Stomach, breast, and prostate cancers

High plasma levels of vitamin C, some carotenoids, retinol, and alpha-tocopherol, as well as high intake of cereal fibre and high adherence to a Mediterranean diet have been found to be associated with a decreased risk of stomach cancer, whereas consumption of red and processed meat is associated with an increased risk. High intake of saturated fats and high alcohol consumption are associated with an increase in breast cancer in women. A high intake of dairy protein and calcium from dairy products is linked to an increased risk of prostate cancer.

Colorectal cancer

A clear pattern of risk has emerged for colorectal cancer. As shown in the graph, the risk increases with increasing consumption of red and processed meat, whereas risk decreases with increasing consumption of fibre. These findings were regarded as key evidence by the expert panels of the World Cancer Research Fund (WCRF) and the American Institute for Cancer Research (AICR) in their judgement that there is convincing evidence that red and processed meat causes colorectal cancer. They also considered as convincing the evidence of a preventive role of consumption of fibre, as contained in plant foods.

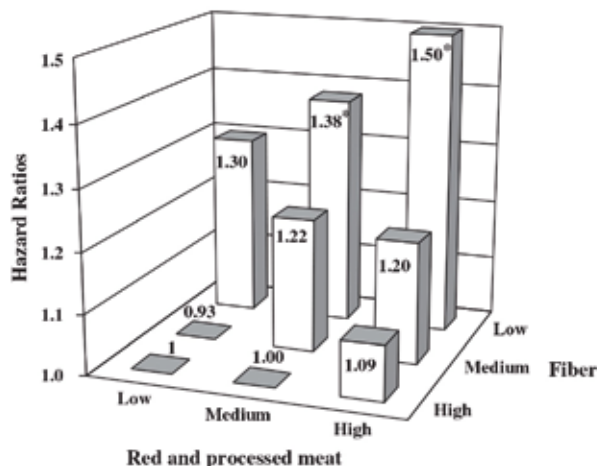

Relative risk of colorectal cancer in the EPIC study. The height of the columns expresses the value of the risk relative to the baseline of 1 for intakes of red and processed meat and fibre. The risks were computed after adjusting for 10 influential factors, including age, sex, and smoking status. (Asterisks indicate statistically significant differences relative to the group of subjects with low intake of red and processed meat and high intake of fibre.)

DIET CAN PREVENT CANCER

More results from EPIC

Beyond the specific findings on colorectal cancer, two other results from EPIC have major relevance for cancer prevention. First, a clear relationship was found between body fat (measured by the body mass index) as well as abdominal fat (measured by the waist circumference or the ratio of the waist to hip circumferences) and the relative risk of dying from any cause. This resulted from increased mortality for all cancers, cardiovascular diseases, and respiratory diseases, a finding consistent between sexes and countries.

The paper in the *New England Journal of Medicine* reporting these analyses has been widely cited as contributing key information on the adverse influence of body fat on all-cancer mortality. In particular, it showed that the smaller the waist the lower the mortality. Results from EPIC challenged a long-held concept

in medicine – that of “the ideal weight” – by showing that the apparent increase in mortality in subjects who are very lean in terms of body mass index is an artefact due to people with a low body mass index but a relatively large waist. This novel finding has since been confirmed by other epidemiological investigations and by a recent IARC study of the global burden of cancer attributable to obesity (see the chapter “Cancer patterns, trends, and burden”). Obesity results from an imbalance between caloric intake through the diet and caloric expenditure. However, diet can also affect cancer occurrence via factors other than obesity.

WCRF/AICR had issued a series of diet-related recommendations for cancer prevention, condensed into six points, concerning body fat, physical activity, foods and beverages promoting weight gain, plant foods, animal foods, and alcoholic beverages (for women, there was a seventh point, concerning breastfeeding). Numerical scores were developed to reflect the degree of adherence to each of the recommendations of every participant in EPIC. For instance, with respect to plant foods, people eating on average more than 400 grams of fruits and vegetables per day got a score of 1, people eating 200–400 grams per day got a score of 0.5, and those eating less than 200 grams per day (one third of the participants) got a score of 0. When all of a participant’s scores were added up, it was found that for people with the highest composite scores, mortality was reduced by one third compared with people with the lowest composite scores. This reduction applied to death rates for all cancers, cardiovascular diseases, and respiratory diseases.

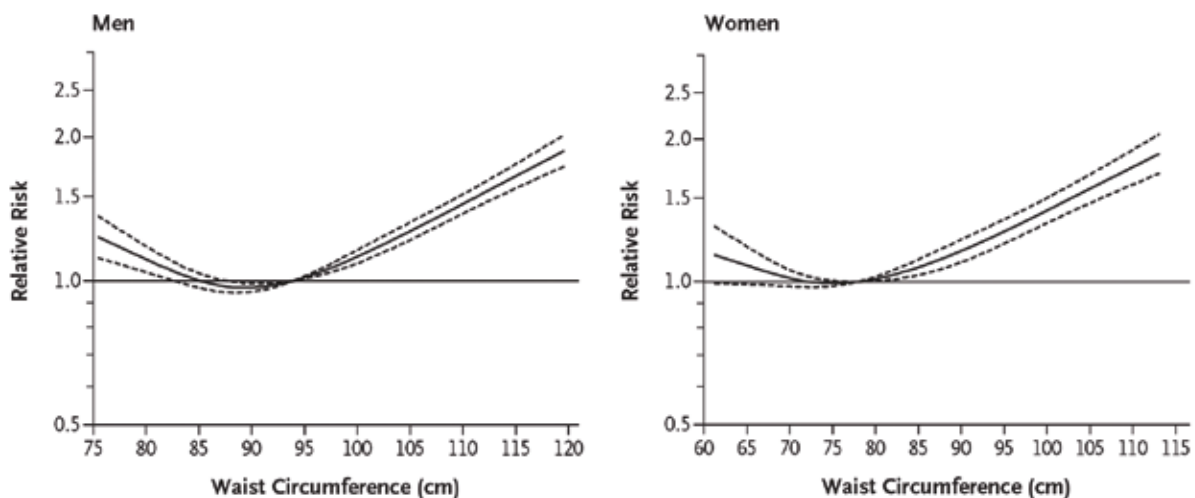

Relative risk of dying from any cause among men and women in the EPIC study. The risk increases markedly with increasing body fat as measured by the waist circumference. The dotted lines indicate the range of uncertainty around the solid trend line.

From knowledge to action

Results from EPIC-based investigations have major implications for the prevention of cancer as well as of other chronic diseases. First, they point to the adverse influence of body fat and caloric imbalance, which involves both diet and physical activity, on the risk of death from cancers. They also indicate that, in addition to caloric imbalance, the risk is more broadly affected by factors in the diet. Second, these influences extend to other noncommunicable diseases, notably diabetes, cardiovascular diseases, and respiratory diseases (see “EPIC and chronic noncommunicable diseases”). Therefore, a substantial scope has been opened for prevention of noncommunicable diseases via diet-related intervention. However, it is paramount to recognize that prevention of noncommunicable diseases cannot be effectively achieved only through laudable recommendations made to individuals or through interventions by health services. As Margaret Chan, Director-General of the World Health Organization, has stated, “The health sector has no control over the cheap and convenient availability of processed junk food, the consumption of tobacco and alcohol, and the weight problems that go with sedentary city lives. ... The striking rise of noncommunicable diseases illustrates

EPIC AND CHRONIC NONCOMMUNICABLE DISEASES

From the very beginning, EPIC was conceived as a dual system. First, it would be a prospective cohort study to explore and test several specific hypotheses about dietary factors in cancer etiology, for instance the possible role of fats in the causation of breast cancer. Second, it would also provide an open resource not only for studies of cancer but also for etiological explorations of other chronic noncommunicable diseases. Two examples of such studies are already well developed: the InterAct and EPIC-CVD research programmes.

InterAct (www.inter-act.eu) was funded by the European Union FP6 programme to investigate how genetic factors and lifestyle behaviours, particularly diet and physical activity, interact (hence the name of the programme) in their influence on the risk of developing type 2 (so-called adult-type) diabetes. Of particular relevance are the findings that moderate physical activity appreciably reduces the risk of type 2 diabetes in both people of normal weight and overweight people, whereas consumption of sugar-sweetened foods increases the risk.

EPIC-CVD (www.epiccvd.eu) is dedicated to the investigation of cardiovascular diseases, in particular coronary heart disease – the focus of the EPIC-Heart project – and stroke. More than 10 000 EPIC participants have developed heart disease since they joined the study in the 1990s. Studies are in an early phase, with the ultimate objective of improving the identification of people at particularly high risk of developing myocardial infarction or other acute coronary syndromes.

Thus, EPIC is making a contribution well beyond cancer. In this context, the opportunity to look at comorbidities with other chronic diseases and to focus on healthy ageing is providing fresh impetus to this 20-year-old project.

the vast collateral damage to health caused by policies made in other sectors and in the international systems. Knowing the right policies is easy, but putting these policies in place is an enormous challenge. Establishing and enforcing health-promoting policies means pushing for fairness against some extremely powerful and pervasive commercial interests.” Pushing for fairness can take very different and successful forms, provided that researchers and health professionals are firmly committed to it, using scientific evidence not as an end in itself, however noble, but as an instrument for action.

FROM DEVELOPED COUNTRIES TO DEVELOPING COUNTRIES

When IARC began its research activities, in the late 1960s, the less-developed countries were facing problems of under-nutrition, not over-nutrition and obesity. Concerns with respect to diet and cancer were focused in these regions on food contaminants rather than food constituents. Consequently, there was a natural orientation to study the effects of diet and metabolism in the more-developed countries, notably through EPIC. Over the history of IARC, however, a transition has occurred such that many developing countries now face problems of both over- and under-nutrition as lifestyles more typical of industrialized countries are adopted. As a consequence, IARC is extending its studies of diet into different regions of the world, where there is often also an associated need to provide training and expertise in dietary methodology. Notably, IARC has started to work with a network of nutrition groups across Africa in the Africa’s Study on Physical Activity and Dietary Assessment Methods (AS-PADAM) project to develop methodology and capacity for joint research.

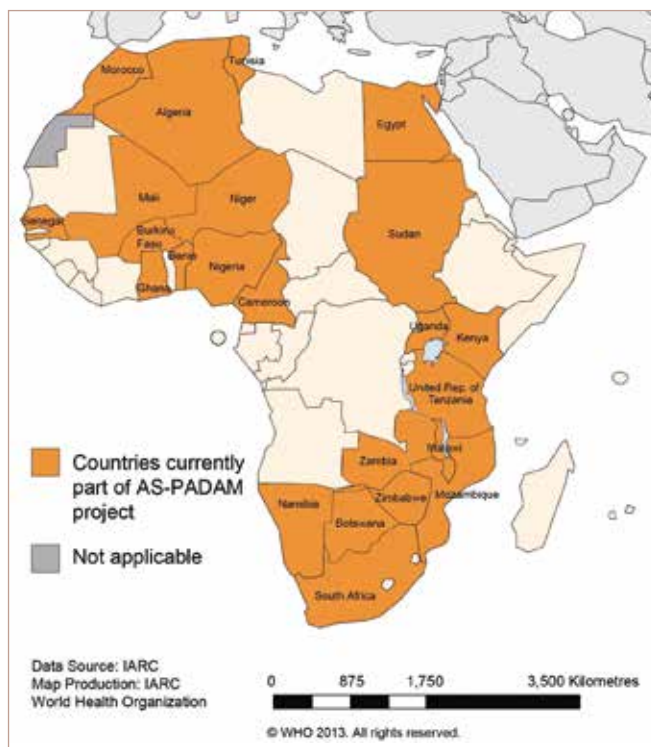

The map shows the countries that are participating in the Africa’s Study on Physical Activity and Dietary Assessment Methods (AS-PADAM) project. The aim of the project is to carry out an inventory of the availability, quality, and challenges of dietary and physical activity methodologies and cancer registries in different African regions and to evaluate the possibility of using GloboDiet as the reference methodology for future pan-African monitoring surveillance. The African network includes representatives from four geographical areas (north, south, east, and west) and currently comprises 23 countries.

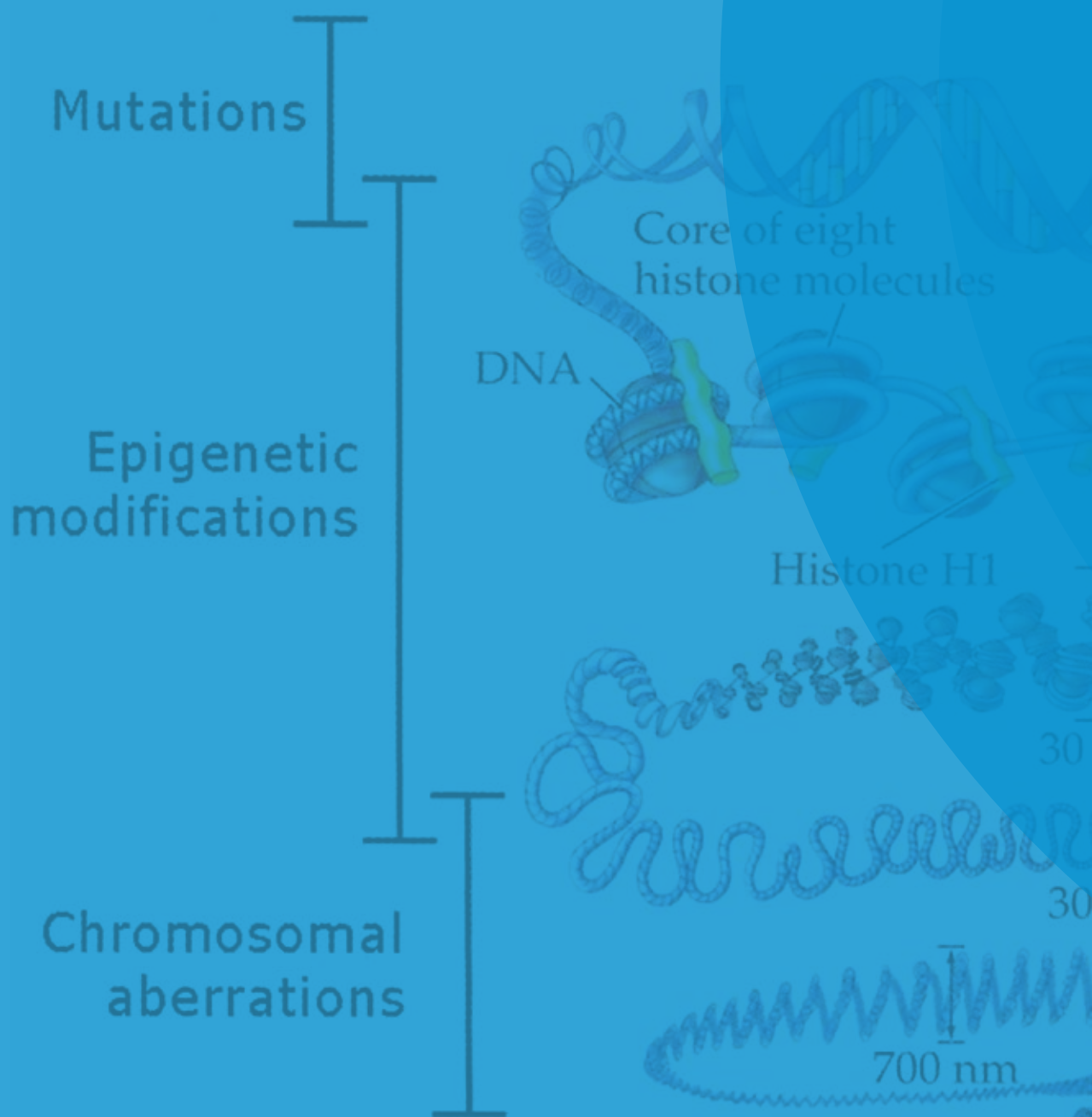

FROM LABORATORY TO POPULATION

DNA double helix



2 nm

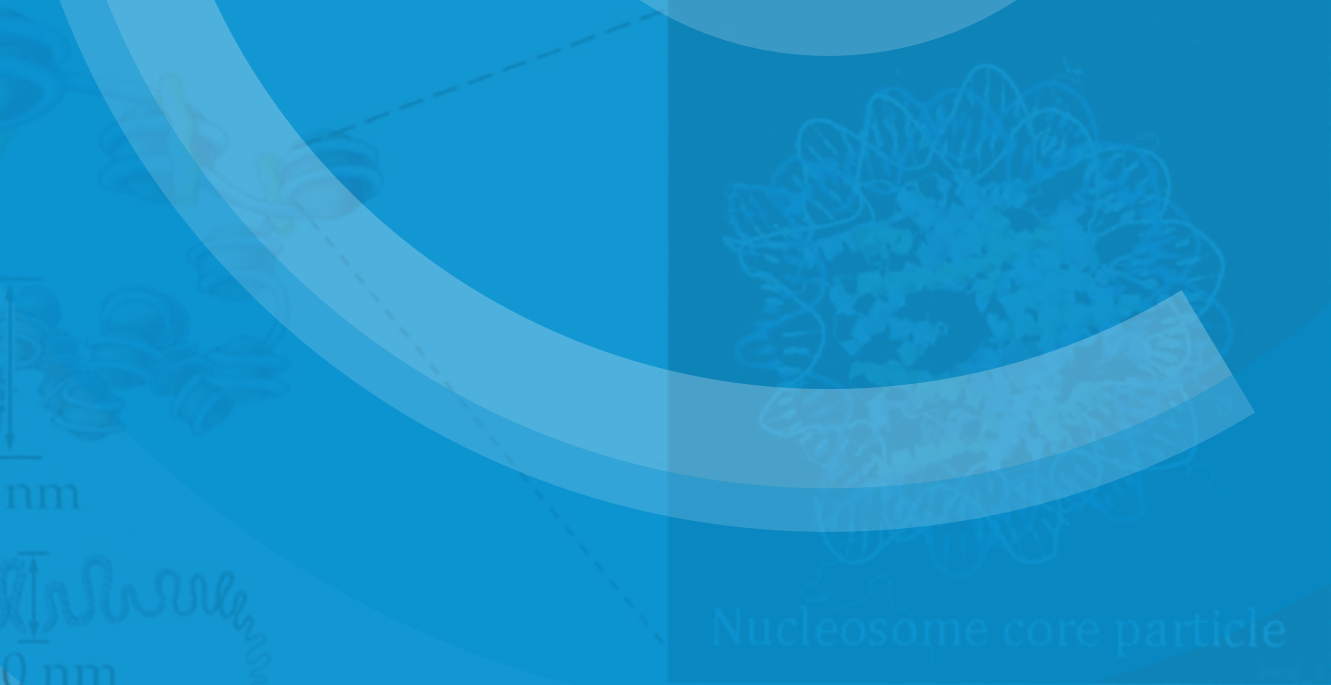

Nucleosome core particle

nm

0 nm

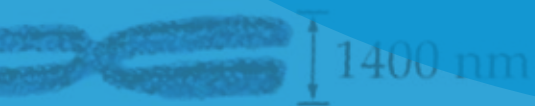

1400 nm

FROM LABORATORY TO POPULATION

For half a century, IARC has been performing both laboratory-based and epidemiological research. The combination of these two fields, today a common occurrence in cancer research institutions, was infrequent in 1965, when IARC was established. Developing a substantial volume of research in each of these two fields under the same roof keeps scientists abreast of advances in both, helping them to formulate prompt responses to new opportunities for interdisciplinary work. This interdisciplinary approach has given IARC a distinctive profile, not only among cancer research institutions but also within the World Health Organization (WHO), to which it belongs.

The link from laboratory-based research to epidemiology and to public health has been IARC's *raison d'être* throughout its history. As Helmut Bartsch (whose work is mentioned in the "Biological mechanisms" section of this chapter) pointed out, "In the 1970s, it was realized that an enormous gap existed between laboratory benchwork and studies in humans. IARC researchers played a leading role in a rapprochement between experimentalists and epidemiologists."

However, this approach also poses challenges. Not all research can be interdisciplinary because each field has its own internal logic and momentum. In a moderately sized institution like IARC (with less than 350 personnel), tensions may arise about the overall direction of research and the allocation of resources. Keeping the right orientation and balancing investments of resources have been constant and major policy concerns for the IARC Directors and the Scientific Council and Governing Council. The approach has been fully justified as radical advances in knowledge and technology in the areas of genetics and epigenetics have increasingly shifted laboratory-based research from studies that are possible only in experimental animals or cell systems to investigations that are directly feasible in humans, on a small or large (epidemiological) scale.

In 50 years, the range of laboratory-based research carried out at IARC has spanned several domains: biological measures (biomarkers) of exposure to agents present in the environment that may cause cancer; genes as potential primary causes of cancer, expanding more recently into epigenetic inheritance; analyses of specific biological mechanisms leading to cancers; and, finally, potential predictors of disease. A large repository of biological samples has facilitated this work, with IARC placing emphasis on samples from epidemiological rather than clinical studies (see "The IARC Biobank").



The raison d'être of the Agency was really to combine epidemiology and laboratory research, and integrate them in order to prevent specific types of cancer.

– Ruggero Montesano,
former IARC scientist

THE IARC BIOBANK

The IARC Biobank (ibb.iarc.fr) is one of the largest and most varied international collections of biological samples focused on cancer. It contains both population-based collections, from research projects like the European Prospective Investigation into Cancer and Nutrition (EPIC; see the chapter “Nutrition, metabolism, and cancer”), and disease-based collections, which focus on biomarkers, as in the International Head and Neck Cancer Epidemiology (INHANCE) consortium.

The IARC Biobank contains about 5 million biological samples from 1.5 million people. As shown in the figure, most of the samples are body fluids, especially plasma and serum; a substantial proportion consists of extracted DNA. Standard operating procedures are used for accessing, retrieving, and fractioning the specimens and transferring them to laboratories.

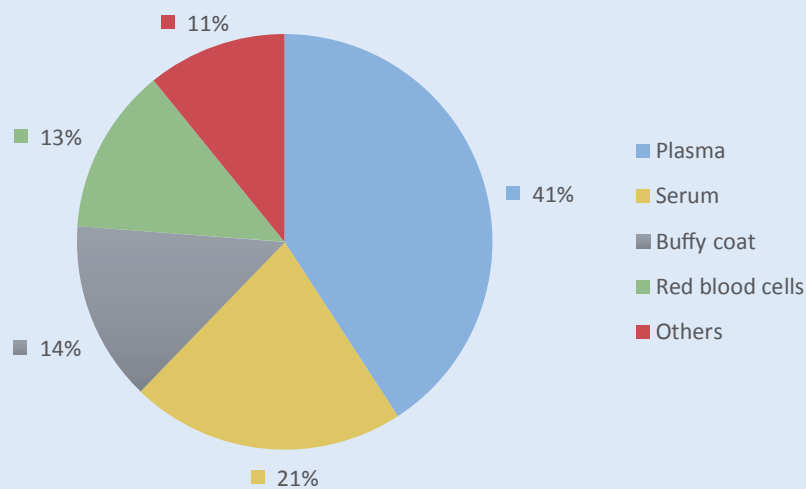

The IARC Biobank contains a variety of fluid and tissue specimens. The largest proportions are represented by blood components such as plasma, serum, red blood cells, and the “buffy coat” layer (which contains the white blood cells).

The IARC Biobank is under the responsibility of an IARC scientist and is overseen by the IARC Biobank Steering Committee, in which all research groups are represented. Because one of IARC’s major roles is to promote scientific cooperation, a formal policy on access to the samples for research purposes has been developed. As a rule, proposals to access the samples are reviewed for approval by the Biobank Steering Committee and by the IARC Ethics Committee.

IARC also uses its international experience to contribute to the development of best practice in biobanking. A significant landmark was the publication in 2007 of the IARC Working Group Report *Common Minimum Technical Standards and Protocols for Biological Resource Centres Dedicated to Cancer Research*, produced after international consultation. IARC is supporting the adaptation of biobanking best practice to resource-limited settings through the Low- and Middle-Income Countries Biobank and Cohort Building Network (BCNet; bcnet.iarc.fr).

BIOMARKERS OF EXPOSURE TO CARCINOGENS

These biomarkers are indicators of chemical, physical, or biological agents present in the environment that have affected the body. A biomarker may be a chemical that is unaltered and directly measurable, for example when a carcinogenic molecule can be detected in the blood. Or a chemical may be modified in various ways by physiological mechanisms but still be recognizable, for example when the molecule is transformed by oxidation into a specific metabolite. A biomarker may also be the product of an interaction between a chemical and a molecule or cell in the body, for example when adducts (a contraction of “addition products”) are formed.

At IARC, an uninterrupted stream of laboratory-based research has focused on biomarkers of exposure – principally the measurement in body fluids or blood cells of carcinogens themselves (free, or bound to some physiological compound) or of the initial damage they may induce in DNA. The need for improved exposure assessment in epidemiological studies is an area where laboratory sciences, along with other technologies, promise significant advances (see “The exposome”).

Measuring carcinogenic substances

Investigations in the late 1960s and the 1970s on the possible role of aflatoxin ingestion in liver cancer risk in Africa relied on measurements of aflatoxin in food samples (see the chapter “Carcinogens in the human environment”). Much more valid would have been direct measurements of how much aflatoxin a person had actually absorbed from eating contaminated food. The development of pertinent methods of measurement subsequently made it possible to assess aflatoxin levels in body fluids like urine or breast milk. Even better are measurements that enable assessment of the accumulation of aflatoxin as a result of chronic exposure.

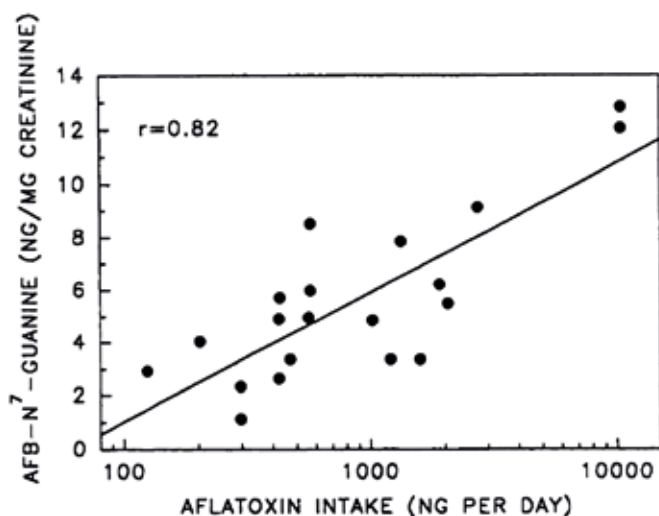

Aflatoxin measured in the plate-ready food of 20 Gambians over an 8-day period (horizontal axis) closely correlated with the excretion of an aflatoxin adduct in the urine (vertical axis), thus validating the biomarker as a measure of individual exposure to the carcinogen in the diet.

THE EXPOSOME

The concept of the exposome is currently being implemented and developed as a collaborative endeavour of IARC and scientists around the world. The idea, initially developed by Christopher Wild, is to measure the effects of lifelong environmental exposures on health. It stemmed from the realization that although it is now feasible (and is becoming increasingly cheaper) to explore a person's whole inherited complement of genes, the non-genetic factors potentially involved in cancer causation have been explored only very partially and have been measured one by one. This discrepancy has roots that are biological as well as technical: all genes – unchanged throughout life – can be measured using the same technology (however complex), whereas measuring exposure to highly heterogeneous and time-variable environmental factors requires disparate technical methods. However, recognizing that all these factors belong to an ensemble – the exposome – prompts both the search for common methods of measurement and a better-organized, more systematic approach to the assessment of the great variety of exposome components (depicted in the figure).

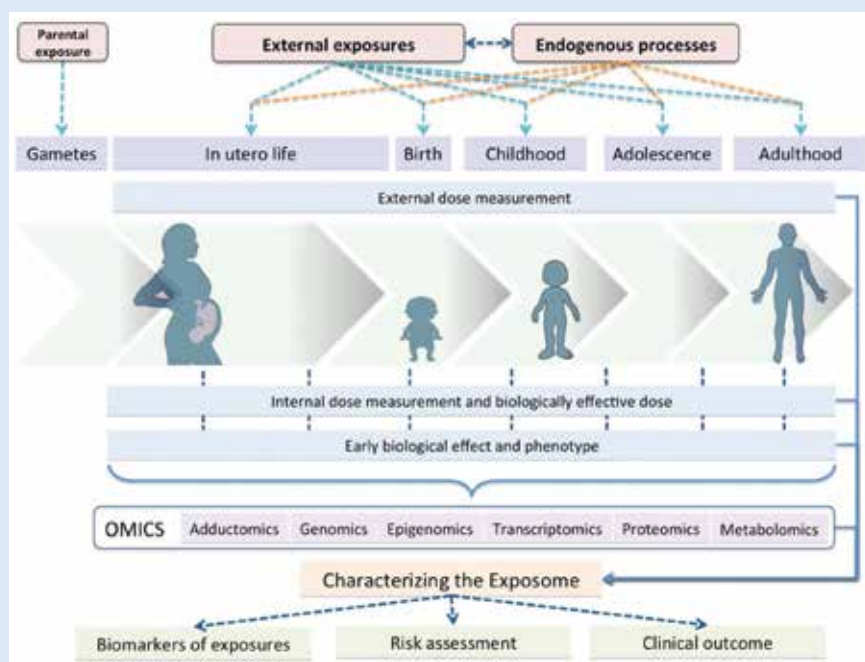

The exposome comprises every exposure to which an individual is subjected over a lifetime. Exposures arise from two broad categories: external and internal sources. External exposures include different environmental and lifestyle factors (e.g. chemicals, infectious agents, diet, tobacco, alcohol, and socioeconomic factors). Internal exposures include endogenous processes (e.g. metabolism, hormones, inflammation, and gut microorganisms).

The concept of the exposome may help drive research efforts to improve exposure assessment and to generate new hypotheses about the causes and prevention of human cancer. As outlined in the figure, each person undergoes a multitude of exposures, starting from in utero life, via the mother, and continuing throughout the life-course (in fact, exposures affecting the sperm and ova of parents may also be relevant). Exposures arise from two broad categories: external and internal (endogenous) sources. External exposures include different environmental and lifestyle factors such as chemicals, infectious agents, diet, tobacco, alcohol, and the social determinants of disease. Internal sources include processes such as metabolism, hormones, inflammation, and gut bacteria. The measurable fingerprints of these exposures characterize the exposome. They can be of practical utility to recognize, and then remove, a carcinogenic exposure, or to assess the size of the cancer risk associated with it, or for an early clinical diagnosis of a cancer.

Aflatoxins bind to proteins such as albumin and to DNA to form adducts. Levels of aflatoxin–albumin adducts in blood samples serve as a biomarker for assessing chronic exposure, while aflatoxin–DNA adducts in urine provide a shorter-term measure. Thus, measurement of such adducts has become one of the tools of public health programmes targeted at the detection and removal of this food contaminant.

Laboratory methods for measuring biomarkers of exposure expanded rapidly in the late 1970s and the 1980s, as highlighted in *Methods for Detecting DNA Damaging Agents in Humans: Applications in Cancer Epidemiology and Prevention*, a 1988 IARC review publication that included several contributions from IARC laboratories. It became possible to reliably measure potential carcinogens from a variety of sources: diet, polluted air (outdoors or in a workplace), medications, alcoholic beverages, and others. As a result of the enormous interest in this area, from 1978 to 1993 IARC published a series of 12 technical volumes, *Environmental Carcinogens: Methods of Analysis and Exposure Measurement*, describing validated methods for analysing chemicals and mixtures ranging from volatile nitrosamines to indoor air (see “Standards and safety”).

Damage to DNA

The binding of a carcinogenic molecule to DNA may be only the first step leading to the damage of DNA. The resulting deleterious change in the DNA structure will persist if several defence mechanisms are overcome. The consequences may range from a simple substitution in one of the DNA base pairs to a large rearrangement of a chromosome. Genetic mutations that play roles in cancer development are continually being identified.

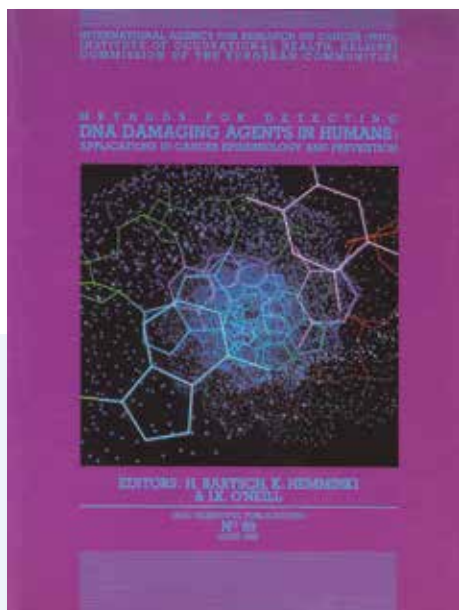

STANDARDS AND SAFETY





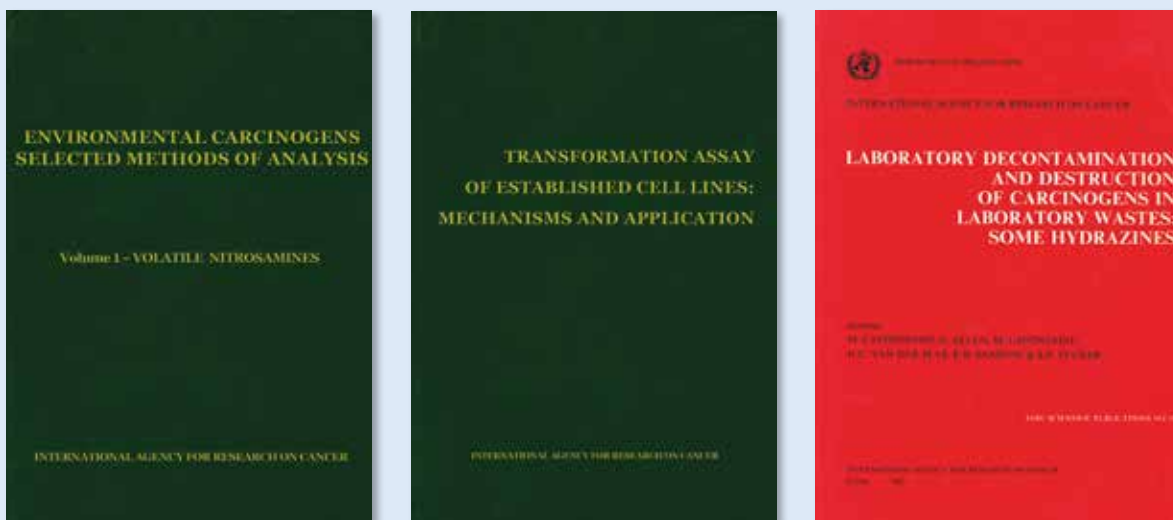

IARC's expertise in laboratory technology and mechanisms of carcinogenesis resulted in valuable resources being made available to the cancer community more widely. In this context, IARC played an important role in reporting on standardized methodologies to measure carcinogens or related biomarkers. For example, the publications on *N*-nitroso compounds, mentioned in this chapter, started with volumes that presented analytical procedures to measure this wide family of carcinogens in various types of samples. This approach was expanded to cover other carcinogens, for example vinyl chloride.

In other instances, IARC supported laboratories in improving their analytical accuracy and precision. A notable example was the mycotoxin check-sample programme, where food samples with known levels of mycotoxins were distributed to laboratories worldwide for analysis. The investigators were able to subsequently compare their results to those of other centres. A similar principle was later followed to measure DNA damage using the ³²P-postlabelling technique, where standard DNA specimens were provided by IARC and analysed by participating laboratories.

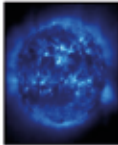
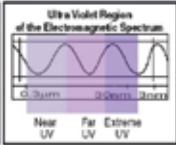

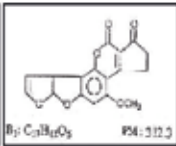
In addition to supporting method validation for chemical analyses, IARC laboratory scientists at different times provided evaluations of cell transformation assays for short-term testing of carcinogens as well as texts on the pathology of tumours in animals. These publications were most frequently released as volumes of the IARC Scientific Publications series subsequent to international workshops of the leading experts in the field.

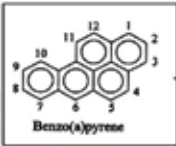
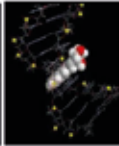
As cancer research expanded, the potential risk of exposure of experimental scientists and others handling chemical carcinogens was recognized. IARC therefore developed a series of manuals on *Laboratory Decontamination and Destruction of Carcinogens in Laboratory Wastes* to provide clear guidance on safe disposal. This series covered many different carcinogens, including polycyclic aromatic hydrocarbons, aflatoxins, hydrazines, aromatic amines, and haloethers.

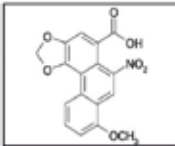
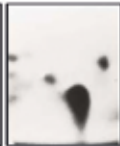
	Source	Mutagen	Damage	TP53 mutations
UV radiations				<u>CC to TT</u> Various codons Skin cancer: 15% Other cancers: <1%
Aflatoxins				<u>G to T</u> Codon 249 Liver cancer: >30% Other cancers: <1%
Tobacco smoke				<u>G to T</u> Codons 157, 158, 248, 273 Lung cancer: 30% Other cancers: <10%
Aristolochic acids				<u>A to T</u> Codons 131 Urothelial cancer

Four examples of mutation patterns and cancer “fingerprints”. The sources portrayed in the first column (ultraviolet radiation, nuts contaminated with aflatoxin, tobacco smoke, and botanical products containing aristolochic acid) contain the carcinogens shown in the second column, which each produce a specific adduct, as depicted in the third column, and a particular TP53 mutation pattern, described in the fourth column.



Ruggiero Montesano, seen here in his laboratory, joined IARC in 1970. For three decades, he was responsible for developing the field of mechanisms of carcinogenesis into several specific research areas. His constant priority was to focus on ways to connect mechanisms with feasible investigations in large human populations.

TP53 is a tumour suppressor gene that acts via a protein (p53) as a gatekeeper, protecting the integrity of cells against a large group of tumour-promoting processes. Mutations that inactivate *TP53* are an important step on the path to cancer. They are found in all cancer types, with frequencies that vary from 5% to 90%. In some instances these mutations are scattered along the whole DNA sequence, while in others they are concentrated at a few mutation hotspots.

IARC scientists were among the first to carry out research on these *TP53* mutation patterns, recognizing their potential value as fingerprints of past exposure to environmental carcinogens. According to Ruggiero Montesano, the key element was the connection between work in the laboratory and at the population level: “There was a lot to do in the laboratory, which was a new one starting from scratch, to develop a technology for measuring mutations, which had to be relatively simple in order to be applicable in thousands of people. ... We were aiming not to discover ‘the cure for cancer’ but to understand the natural history of cancers through mutations caused by specific and removable factors in the environment, like aflatoxin for liver cancer.” The subsequent extension of these analyses to measure a common aflatoxin-associated mutation in codon 249 of the *TP53* gene in the plasma of liver cancer cases provided a promising proof of principle for the

early detection of cancer through non-invasive molecular tests. At IARC, a database was developed by Monica Hollstein that currently documents all *TP53* variations reported in the scientific literature (p53.iarc.fr). More than 30 000 mutations occurring in tumours are included, accompanied by a rich annotation of tumour characteristics.

Fingerprints of exposures in cancer cells

TP53 mutation patterns are just one example of how environmental exposures may be traceable in tumour cells through the scrutiny of complex patterns of genetic changes. IARC scientists recently investigated renal cancer in tumour samples from four countries: the Czech Republic, Romania, the Russian Federation, and the United Kingdom. The analysis of the whole genome showed a striking difference in the frequency of a particular type of mutation between countries. The far higher frequency found in the samples from Romania opens up the possibility that renal cancers in that country may be caused by a specific environmental exposure. A good candidate is aristolochic acid. This chemical, which is contained in some herbal remedies and weight-loss preparations, is a known carcinogen. Aristolochic acid is also the cause of a renal disease prevalent in some areas of the Balkans, and it causes the types of mutations seen in the renal cancer samples from Romania.

Exposure fingerprints of various types form an important part of the broad field of molecular epidemiology (see “Molecular epidemiology”).



Mutation patterns in tumour samples from patients with clear cell renal cell carcinoma in four countries. The columns in the small graphs indicate the number of A:T > T:A mutations per sample, out of a total number of 20 000. These mutations consist of changes (transversions) of an adenine–thymine base pair (A:T) into a thymine–adenine pair (T:A). Patients from Romania have an unexpectedly high frequency of A:T > T:A transversions, consistent with exposure to aristolochic acid.

MOLECULAR EPIDEMIOLOGY

In epidemiological studies, often a substantial portion of the information is gathered through questionnaires, for example enquiring about characteristics such as sex, age, educational level, diet, and tobacco use. There is also a long history in epidemiological research of direct measurements in the human body, particularly since it became possible – in the second half of the 19th century – to isolate disease-causing bacteria from organisms found in animals and humans. Immunological markers of exposure to microorganisms followed, and measurements of blood cholesterol and lipids have been available for decades in cardiovascular epidemiology. However, the blossoming of molecular biology has hugely amplified the scale on which biological traits, ranging from exposure fingerprints to genes and gene products, can be usefully incorporated into epidemiological studies of cancer and other diseases. This increase in scale has necessitated the development of new statistical methods and bioinformatics tools to organize and interpret the vast amount of information generated.

The 2011 IARC publication *Molecular Epidemiology: Principles and Practices* is an extension of work that began 25 years earlier, with IARC's 1986 course on "Molecular biology for epidemiologists", and continued with several IARC courses on molecular epidemiology (see the chapter "Education and training of cancer researchers"). In the style of a methodological textbook, more than 60 scientists from IARC and institutions around the world present a comprehensive survey of the current status of molecular epidemiology – a broad label that embraces epidemiological studies using measurements of any kind of biological molecules, from small ions of, say, sodium or potassium to large structures like DNA or proteins. Molecular epidemiology is a principal instrument of today's translational medical research, centred on converting the results of basic research into tools for clinical practice and public health.

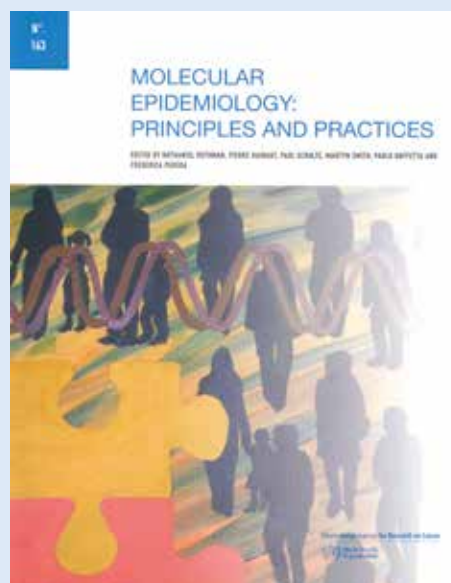

GENES AND CANCER

Cancer has been defined as a genetic disease because gene alterations are key steps in the processes that transform a normal cell into a cancer cell capable of propagating to the stage of clinical cancer. However, genes can also predispose to cancer when particular variants occur in the germ cells (sperm and ova) of parents. For example, a rare hereditary mutation of *TP53* is transmitted from parents to offspring as a dominant gene, conferring a very high risk of cancer in one or more of several organs (the breast, soft tissue and bone, the brain, and bone marrow).

In multiple endocrine neoplasia type 2A (MEN 2A), cancers develop in the thyroid and adrenal glands, which are hormone-secreting organs.

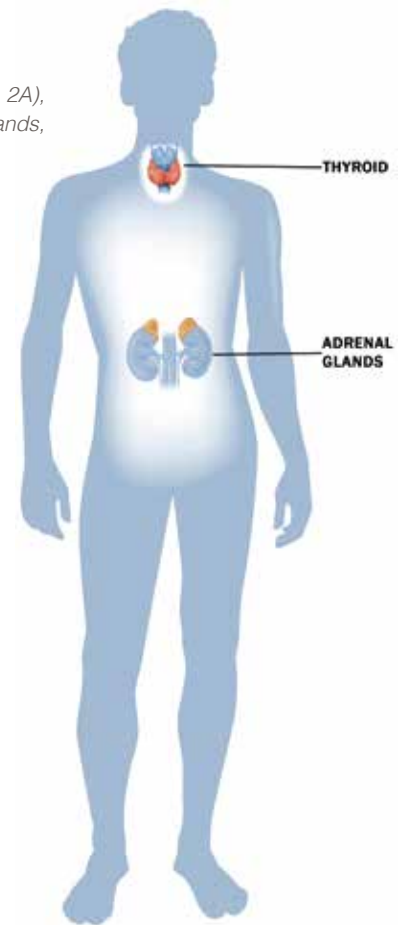

Studies of cancer-predisposing genes have been carried out at IARC since the technology first permitted the direct detection of inherited genetic variants. Priority was given to cancers that often occur with elevated frequency within families. The aims were both to better understand the biological basis of the predisposition and to make genetic counselling possible by identifying the individuals at risk within such families. An early example was a condition called multiple endocrine neoplasia type 2A (MEN 2A), which is genetically inherited and affects 1 in 25 000 people, in whom cancers of the thyroid and adrenal glands develop.

To detect and remove such MEN 2A-associated cancers at a very early stage, it is important to regularly screen for neoplastic changes in those relatives of affected people who carry the genetic variant responsible. In the late 1980s, a collaborative IARC study in France identified three DNA markers that enabled the identification from a young age of people carrying the version of the gene that confers a high risk. A similar approach in the USA in five large families with hereditary transmission of predisposition to breast and ovarian cancers resulted in the identification of a region on chromosome 17 where the genetic variant responsible for the predisposition is located.

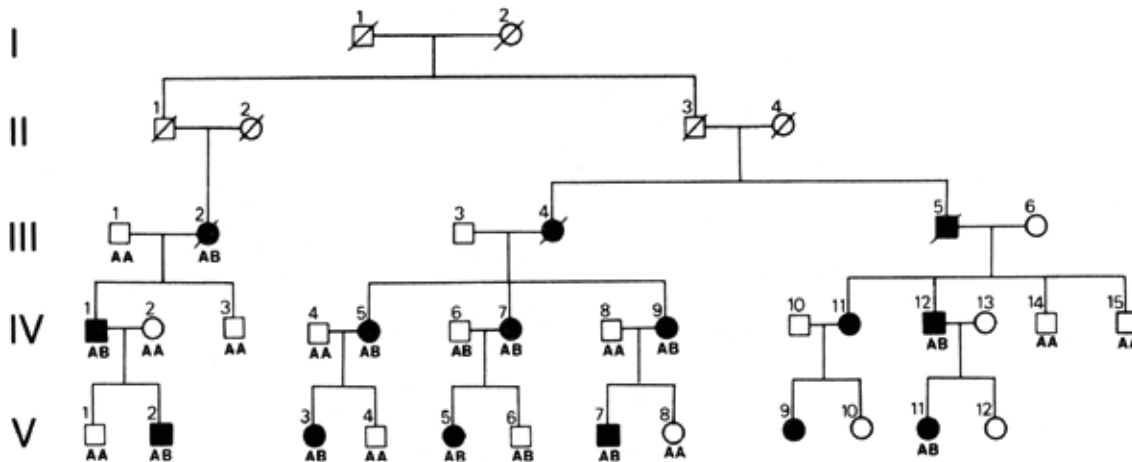

Example of a multigenerational family with members affected by MEN 2A. Circles indicate females and squares males; filled symbols show affected individuals, and slashes denote those who are deceased. The letters represent the combination of genetic variants in a person tested for a DNA marker in order to provide genetic counselling. For example, subject V-1 was a 15-year-old boy not (yet) affected by the disease. The testing had established that the mutation causing MEN 2A was associated with the B variant in the father. Although the B variant was passed on to subject V-2, subject V-1 had only A variants, and thus he could reasonably be reassured that he would never develop the disease.

DNA analyses of members of families with an unusually high frequency of cancers, notably breast cancer, were fast multiplying. Therefore, in November 1989, IARC convened an international workshop on Linkage Studies of Hereditary Breast Cancer, to critically review the methodological aspects of these studies and scrutinize the validity of the results that had already been acquired. To accelerate the pace of discovery of genes responsible for hereditary breast cancer, a network was launched whereby data submitted by participant scientists would be tabulated, summarized, and redistributed to the contributors. Gilbert Lenoir had promoted the initiative with Bruce Ponder from Cambridge, United Kingdom. Lenoir noted that IARC was in an ideal position to enter the young field of genetic epidemiology, because of the Agency's experience in organizing the large international collaborations needed to successfully assemble an adequate number of families affected by uncommon hereditary cancers throughout the world. More generally, according to Lenoir, IARC's reputation was such that "an IARC business card opened doors and made everything possible, because of the link with WHO. For example, to set up a new collaboration, it was enough to send a letter mentioning WHO/IARC/Lyon and you would always receive a reply, while this would not necessarily happen for a letter emanating from another institution."



At IARC, Gilbert Lenoir (left) combined research on viral carcinogenesis with the initiation and development of the cancer genetics programme. After holding a professorship in medical genetics at the University of Lyon, he became scientific director of the Gustave Roussy Institute in Paris. Here, Lenoir is with Nobel Prize laureate Harald zur Hausen on the occasion of the awarding of the 2009 IARC Medals of Honour to zur Hausen and Nubia Muñoz, for their discovery that human papillomaviruses cause cancer of the uterine cervix.

This strength, arising from the combination of technical capability, extensive experience, and status within WHO, has sustained IARC's expanded role in international genetic epidemiology until the present day. Research in this field has shifted focus: from rare genetic variants entailing a very high risk of cancer, as was found with the uncommon *BRCA1* and *BRCA2* genes responsible for a small fraction of breast cancers, to common genetic variants that each potentially contribute a small increase in risk. Recent IARC-coordinated studies exploring the whole genome (genome-wide association studies, or GWAS) have identified several genetic variants potentially involved in the causation of renal cancer, cancers of the upper respiratory and digestive tracts, and lung cancer. When the evidence from more than 4000 lung cancer cases and 7000 controls in five separate studies (including the European Prospective Investigation into Cancer and Nutrition [EPIC] and the IARC Central Europe lung cancer study) was combined, a genetic variant located on the long arm of chromosome 15 was found to be associated with an increased risk of lung cancer.

EPIGENETICS

Epigenetics is a new, rapidly expanding field of research in cell biology, including cancer biology. Epigenetics encompasses the study of all changes in gene expression that are passed on from one generation of cells to the next but do not involve changes (such as mutations) in the DNA sequence itself. The emergence of epigenetics has challenged the dogma that the only heritable characteristics are those coded in the DNA sequence. It has also opened up a vast field of research on heritable epigenetic changes that are induced by environmental exposures, presenting novel ways to study the mechanisms by which such exposures lead to cancer development.

As in the case of mutations, laboratories at IARC are developing ways to measure epigenetic alterations in the minute amounts of tumour DNA that can be found circulating in the blood. This makes it realistic to apply these sophisticated measurements to biological samples collected and stored for epidemiological studies. Early initiatives are showing how different diets may result in epigenetic changes involved in the development of breast cancer.

BIOLOGICAL MECHANISMS

Research on biological mechanisms of cancer development has often focused on elucidating epidemiological findings, in terms of underlying physiology and pathology. This approach of investigating the biological plausibility of an

“
In the same building there were people with expertise in epidemiology and in understanding mechanisms, and I enjoyed the cross-talk. I learned from it and I think it has sustained me since I left IARC. There was that wonderful cafeteria and coffee bar on the top floor; I think that is where the real collaboration happened.

– Julian Little, former IARC scientist

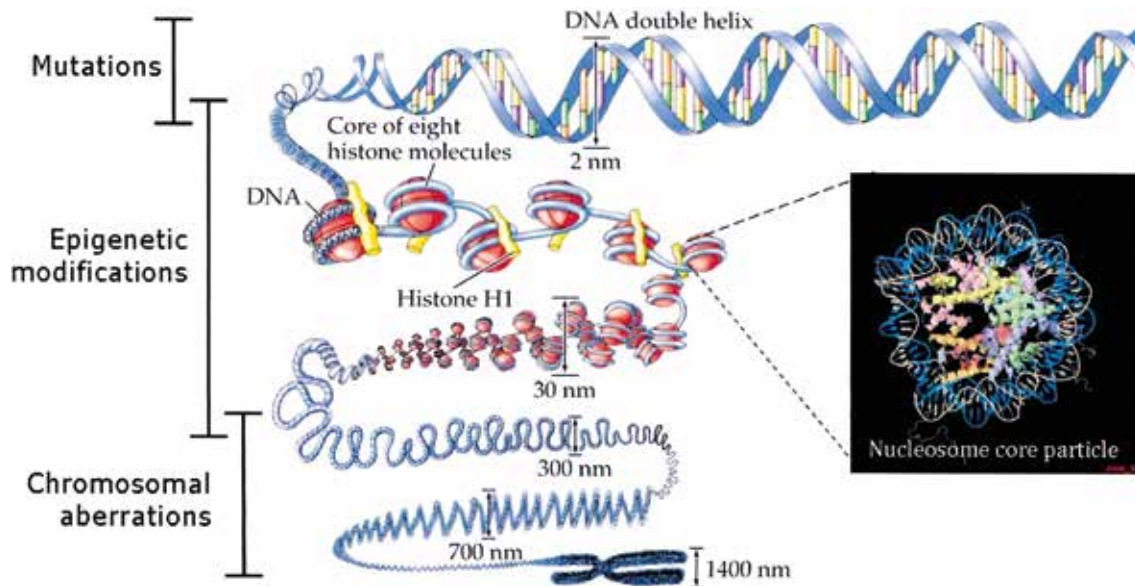

The DNA double helix, which can be modified by mutations, is folded into larger nucleosomes, which are the target of epigenetic changes. The nucleosome chain is in turn folded and packed into the even larger chromosomal structures, which may be altered by gross aberrations. Sizes are indicated in nanometres (nm), billionths of a metre.

epidemiological association has been used for many different agents. For example, *Biological Effects of Asbestos* was one of the first IARC Scientific Publications, and co-editor Pavel Bogovski involved IARC in experiments exploring the relationship between the physical and chemical properties of different types of asbestos fibres and their carcinogenicity. More generally, methods of testing chemicals for mutagenic activity in bacteria were developed as rapid tools for recognizing mutagenic carcinogens. This type of information on mechanisms has supported programmes for the identification of carcinogens in the environment (see the chapter “Carcinogens in the human environment”).

For many years IARC placed great emphasis on *N*-nitroso compounds. These compounds had been known since the 1950s to be potent carcinogens in a wide variety of experimental animals. However, a host of unanswered questions remained about their measurement, distribution, and sources in the human environment, and their actual role in human cancers. *N*-nitroso compounds were fascinating partly because of the wide range of organs affected by different members of this family of chemicals in rodent studies. To keep abreast of progress, IARC organized an international conference in 1969 and published the proceedings in its Scientific Publications series; over the next two decades, 10 further volumes on *N*-nitroso compounds followed, at two-year intervals.

In parallel, IARC laboratories tackled the emerging issue of endogenous formation: *N*-nitroso compounds are not only found preformed (often in minute amounts) in the environment, such as in some foods, tobacco smoke, and polluted air, but – more importantly – are also formed within the body from the precursor molecules nitrate and nitrite, which are widely present in drinking-water. In 1981, Helmut Bartsch and Hiroshi Ohshima reported on a simple and reliable non-invasive test whereby the amino acid proline was given orally and scavenged nitrosating agents, leading to formation of *N*-nitrosoproline, which could be measured in the urine. This test enabled the exploration of the body’s capacity to form endogenous *N*-nitroso compounds, which may contribute more than half of a person’s total exposure to these chemicals. The test was applied widely

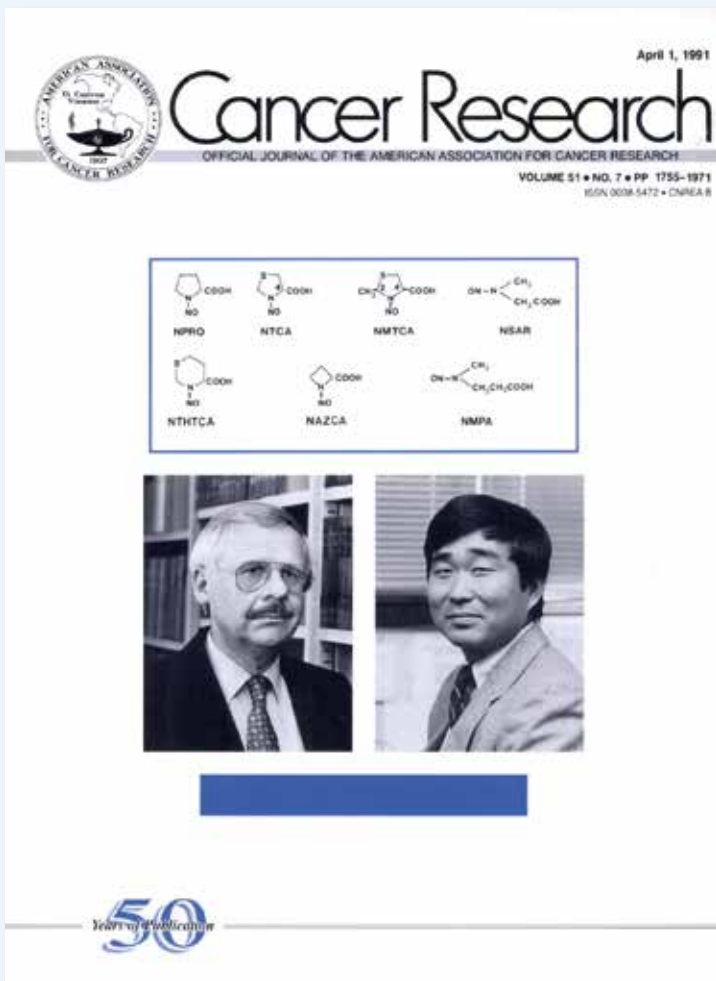

The April 1991 issue of the journal *Cancer Research* featured Helmut Bartsch and Hiroshi Ohshima on the cover and highlighted their development of a simple, sensitive, and non-invasive method for the estimation of endogenous nitrosation in humans. Bartsch (left) conducted research at IARC from the early 1970s to the early 1990s. He then became head of the Division of Toxicology and Cancer Risk Factors at the German Cancer Research Center in Heidelberg. Ohshima (right), a graduate of the Tokyo University of Fisheries, joined IARC in 1979 and moved in 2006 to the Graduate School of Nutritional and Environmental Sciences, University of Shizuoka, Japan.

in epidemiological studies, including an assessment of endogenous nitrosation across 69 counties of China in comparison to oesophageal cancer mortality rates. An understanding of the underlying chemistry also led to the demonstration of a reduction in endogenous nitrosation by ingestion of vitamin C, a potent inhibitor of nitrosation.

In the mid-1980s, IARC scientists were among the first to show that the DNA adducts induced by *N*-nitroso compounds, which had been seen in experimental animals, could also be detected in human tissues. These results came from studies of oesophageal cancer in Linxian County, China. *N*-nitroso compounds also appear to be implicated in stomach cancer, together with the major causative factor, infection with the bacterium *Helicobacter pylori*. This finding comes from earlier IARC laboratory studies and recent results from the EPIC team (see the chapter "Nutrition, metabolism, and cancer"). *N*-nitroso compounds generated from nitrate and nitrite in foods containing red and processed meat may be linked to causation of colorectal cancer, while those formed endogenously by microorganisms that infect humans might play a role in the development of cancers of the bladder and biliary tract.

The adducts formed when *N*-nitroso compounds bind to DNA may, if not repaired, induce mutations that are important in transforming a normal cell into a cancer cell. DNA repair is a defence mechanism in which DNA damage is identified and mended to maintain the integrity of the genetic code. Substantial research into

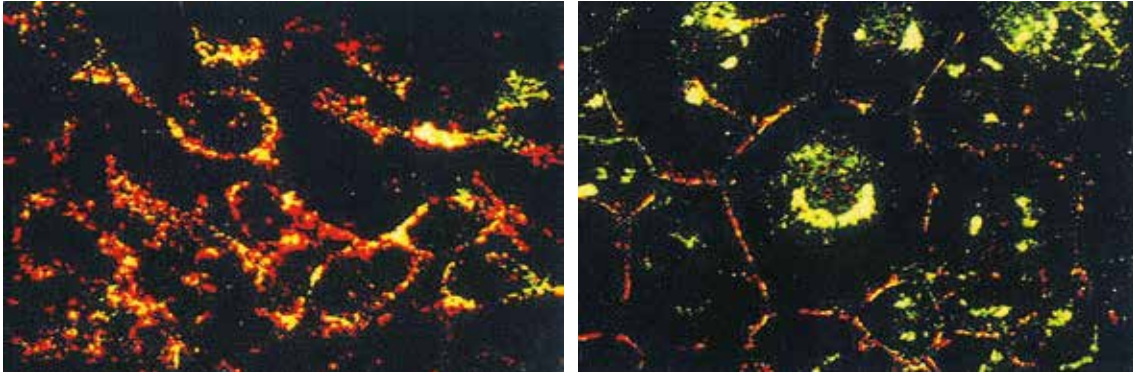

Gap junction intercellular communication is mediated by molecules called connexins. Under the microscope, two types of connexins appear as fluorescent green and red (left image) within cells in culture. When the fluid medium in which the cells are bathed is changed from a low to a high calcium concentration, the connexins migrate to the cell membranes (right image), altering the cell-to-cell communication capabilities.

DNA repair processes has been conducted in IARC laboratories. Chronic (rather than acute) administration of *N*-nitroso compounds to experimental animals was found to increase DNA repair by excision of damaged DNA, an adaptive defence response of the organism to the carcinogen. The DNA damage response was also investigated in heritable conditions, such as ataxia telangiectasia, in which the repair processes are genetically impaired, thus predisposing the affected people to cancer occurrence.



After the initial damage to DNA and associated mutations, the next step in the process that leads to cancer involves a progressively increasing capacity for disordered growth and proliferation of cells. In normal tissues, cells constantly communicate and interact to coordinate and maintain proper functioning. Regulated communication between cells occurs through gap junctions, specialized structures that allow the passage of chemical messages from one cell to another. Mechanisms that disrupt this cell-to-cell communication were studied extensively by the team of Hiroshi Yamasaki, who was a co-editor of the book *Cell Differentiation, Genes and Cancer*, published by IARC in 1988. For Yamasaki, combining basic research with IARC's commitment

For about 20 years, Hiroshi Yamasaki directed IARC's research programme on the mechanisms of intercellular communication that ensure orderly functioning in normal tissues and on how carcinogenic agents can interfere with or disrupt this communication.

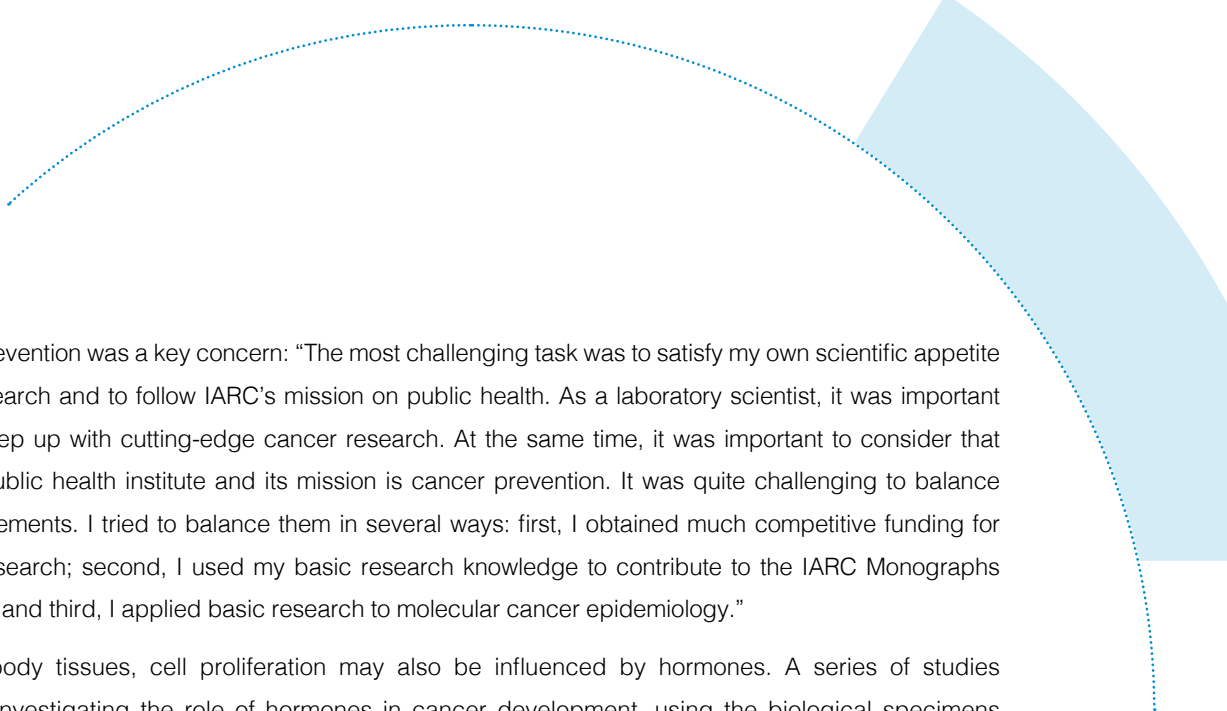

to cancer prevention was a key concern: “The most challenging task was to satisfy my own scientific appetite in basic research and to follow IARC’s mission on public health. As a laboratory scientist, it was important for me to keep up with cutting-edge cancer research. At the same time, it was important to consider that IARC is a public health institute and its mission is cancer prevention. It was quite challenging to balance these two elements. I tried to balance them in several ways: first, I obtained much competitive funding for my basic research; second, I used my basic research knowledge to contribute to the IARC Monographs Programme; and third, I applied basic research to molecular cancer epidemiology.”

In several body tissues, cell proliferation may also be influenced by hormones. A series of studies have been investigating the role of hormones in cancer development, using the biological specimens from the EPIC study (see the chapter “Nutrition, metabolism, and cancer”). Most of the analytical determinations have been performed in IARC laboratories, which have adapted the assays to the requirements of large-scale epidemiological studies. Studies have been conducted mainly on cancers of the prostate, thyroid, colorectum, ovary, and breast. Clarifying the confusing picture that had emerged from previous studies, it was shown that elevated levels of androgen and estrogen hormones, but not of progesterone, increase the risk of breast cancer. Another study found that in postmenopausal women, higher levels of insulin-like growth factor I, which regulates cell proliferation, may increase the risk of receptor-positive breast cancer, but not of receptor-negative breast cancer, the other principal subtype. As these examples show, laboratory-based research on metabolic and hormonal factors enables the identification of specific paths leading to cancer, which are potentially controllable by pharmacological (chemopreventive) means.

PREDICTORS OF DISEASE

Most biological processes related to cancer can be investigated from two perspectives. The “upstream” approach considers direct or remote evidence of causes of cancer, either genetic or environmental. The “downstream” approach identifies predictive indicators of the likelihood of cancer occurrence, or of the course and outcome of an existing cancer. Although most IARC laboratory-based research has been driven by the upstream perspective, with the ultimate goal of preventing cancer by avoiding its causes, the downstream perspective has also been pursued.

Much of the molecular pathology research developed by Paul Kleihues and Hiroko Ohgaki centres on improving the definition and classification of brain tumours with respect to the biology and – most relevantly – the clinical outlook of patients. As an example, the figure shows how complex patterns of molecular markers can differentiate glioblastomas – the most common and most aggressive brain tumours in humans – into subtypes with markedly different clinical durations, ranging from a few months to several years.

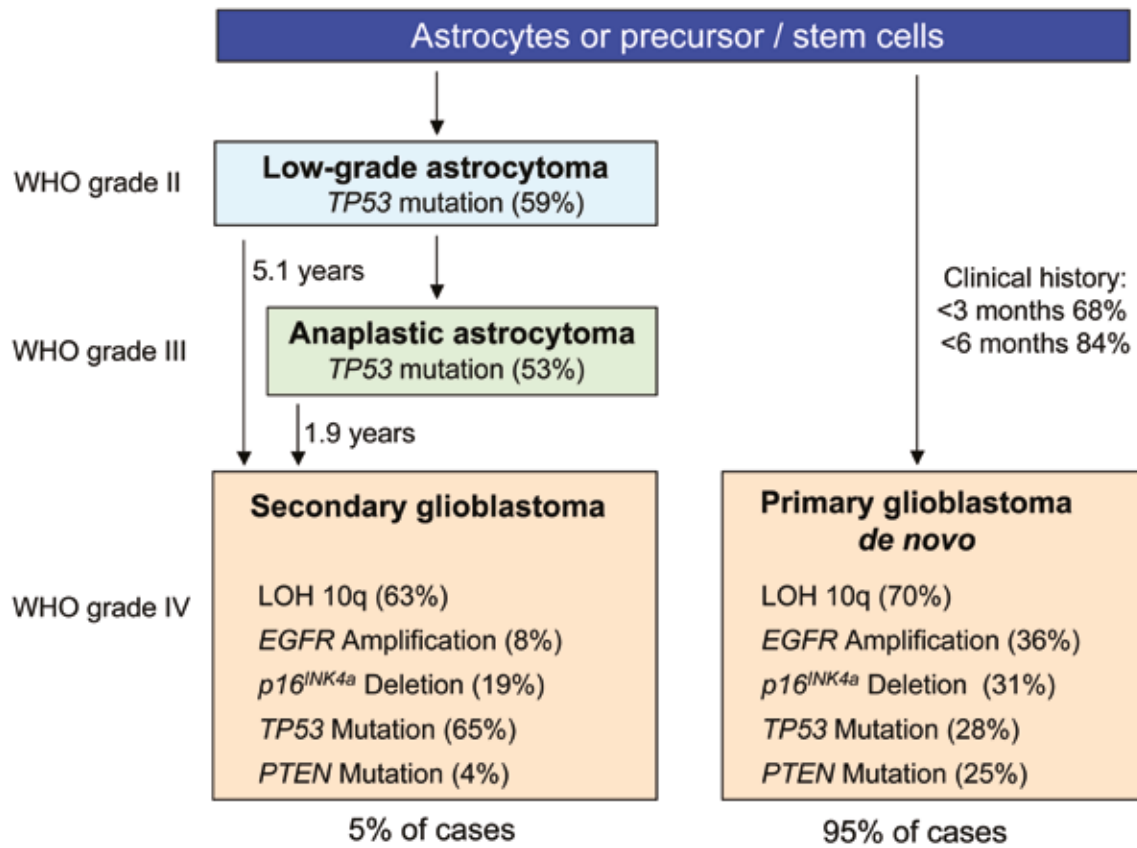

This schematic diagram portrays how glial progenitors – the non-nerve cells that support and protect nerve cells in the brain – give rise to different subtypes of glioblastoma through various sequences of genetic alterations. Primary glioblastomas usually have a short clinical history of 3–6 months. Secondary glioblastomas tend to have a clinical duration of a few years.

Another promising avenue of investigation is the study of microRNAs, small RNA molecules that are involved in the regulation of protein synthesis. A recent IARC study showed that lung cancer cells secrete microRNAs into the blood, making these molecules potential tools for very early diagnosis of the tumour.

For the investigation of predictors of disease, the biological specimens of the EPIC study are once again an eminently suitable resource. A recently published EPIC-based study found a significantly lower level of pre-diagnostic immunoglobulin E levels in subjects who subsequently developed chronic lymphocytic leukaemia.

These more recent studies with a new generation of biomarkers reinforce the more general point that the continued approach of interdisciplinary research has much to contribute to understanding the causes of cancer and how to prevent it.

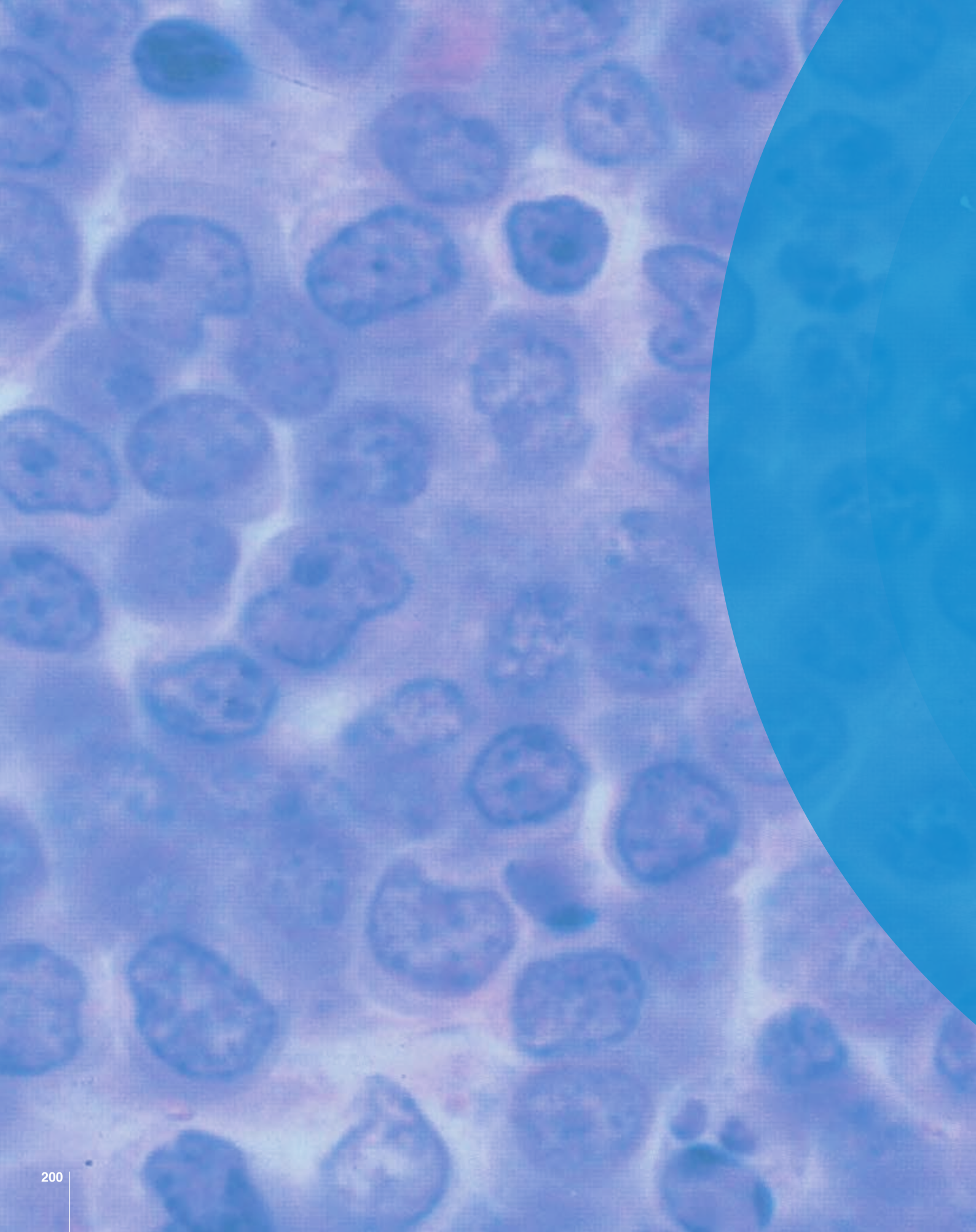

VIRUSES AND VACCINES

VIRUSES AND VACCINES

Which cancers in humans are caused by a virus? In the late 1950s, asking this question was fully justified, given the evidence on cancers induced by viruses in several animal species. The first evidence came from Peyton Rous's pioneering experiments with sarcoma in chickens in 1910 (recognized with the Nobel Prize 56 years later). Since the 1930s, results had followed in rabbits, mice, frogs, ducklings, turkeys, and guinea fowl. Among other findings, these studies showed the possibility of transmission of carcinogenic viruses between species. The first answer to the question of virus-induced cancers in humans came from Africa.

BURKITT LYMPHOMA

The first report of the malignancy that became known as Burkitt lymphoma was published in 1958 (see "The discovery of Burkitt lymphoma in East Africa"). The search for possible causes soon began, and led in 1964 to the identification of a new virus of the herpes family, named Epstein-Barr virus (EBV) after its discoverers. EBV is a DNA virus with versatile properties: it was found to silently infect people from an early age in most countries; it turned out to be the agent of infectious mononucleosis, which is most common among adolescents and young adults; and in the laboratory it became a tool for "immortalizing" lymphoid cell lines, making them continue to grow indefinitely. IARC participated in research on Burkitt lymphoma from its earliest days. It contributed to the standardization of methods to measure anti-EBV antibodies and directed serological surveys to detect the presence of EBV in East Africa. In 1972, IARC initiated a

large-scale prospective study in five counties of the West Nile District of Uganda (see "IARC's prospective study in the West Nile District of Uganda").

The title of the second volume of the IARC Scientific Publications series, *Oncogenesis and Herpesviruses*, published in 1972, documents IARC's interest in the wider field of cancer and herpesviruses. The possibility that these agents, and in particular EBV, could be involved in the development of cancers other than Burkitt lymphoma was suggested by findings of elevated concentrations of anti-EBV antibodies in cases of nasopharyngeal cancer, a tumour frequent in populations of Chinese origin.

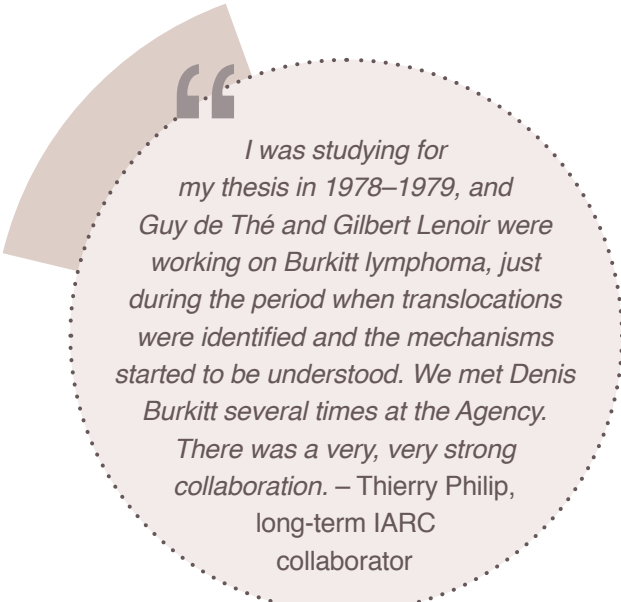

I was studying for my thesis in 1978–1979, and Guy de Thé and Gilbert Lenoir were working on Burkitt lymphoma, just during the period when translocations were identified and the mechanisms started to be understood. We met Denis Burkitt several times at the Agency. There was a very, very strong collaboration. – Thierry Philip, long-term IARC collaborator

THE DISCOVERY OF BURKITT LYMPHOMA IN EAST AFRICA

It had long been known, since the arrival of the first missionary doctors, that various childhood tumours were especially frequent in tropical Africa. Denis Burkitt, an Irish “bush surgeon” practising in Uganda, reasoned that “there is an obvious difference between describing the features of individual trees and recognizing the configuration of the wood, which is composed of the sum total of many trees growing in relation to one another.” He thus realized that “a number of tumours occurring in children in different anatomical sites tended to be related to one another in individual patients. The simultaneous occurrence of tumours in different locations such as the maxilla, mandible, thyroid, ovaries, liver and kidneys demanded explanation and suggested a common origin. The clinical distribution appeared to preclude a primary tumour with bizarre metastases, and the alternative of a multifocal tumour seemed to be more acceptable.”

Soon after the clinical identification, there was histological confirmation that the different tumours were all part of a single neoplastic condition, a malignant lymphoma that arises in lymphoid B cells. The newly described cancer was named after Burkitt. Cases were then documented in other parts of Africa. Today it is known that Burkitt lymphoma occurs in three contexts: in equatorial Africa, where it is the most common childhood malignancy; throughout all other parts of the world, where it is a rare tumour; and in association with HIV/AIDS.



Denis Burkitt (left) with former IARC staff member Gregory O'Connor (centre) and pathologist Dennis Wright at a reception during an IARC meeting on Burkitt lymphoma.

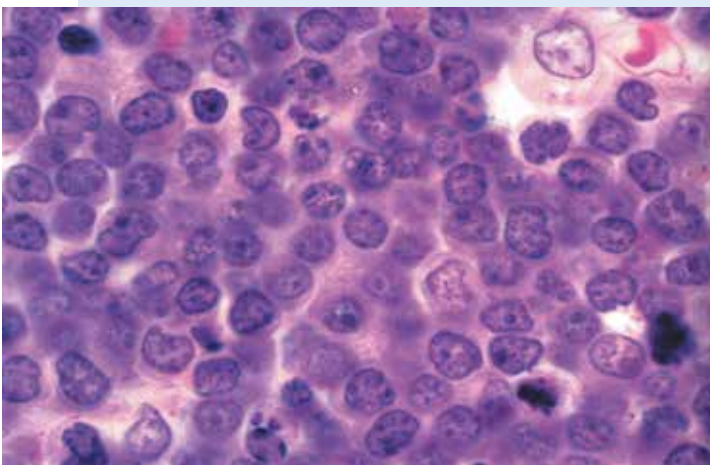

Typical histological appearance of Burkitt lymphoma. The tumour cells are uniform in size and shape, intensely coloured upon staining, and accompanied by occasional “starry sky” patterns (upper right) of benign large cells that have ingested fragments of dead tumour cells.

IARC'S PROSPECTIVE STUDY IN THE WEST NILE DISTRICT OF UGANDA

This prospective study was directed in the field by IARC scientists Guy de Thé and Anton Geser. From 1972 to 1974, about 42 000 samples of blood serum were collected from children aged 0–8 years living in five selected counties of the West Nile District of Uganda. In 1979, civil disturbances made it unfeasible to continue with case finding to identify Burkitt lymphoma cases among these children. By then, 16 cases had been recorded.

The serum samples of each case were tested for infection with Epstein–Barr virus (EBV), as evidenced by the concentration of anti-EBV antibodies, along with the serum samples of five control children of the same

age and sex who had not developed Burkitt lymphoma during the years of follow-up. In most comparisons, the antibody concentrations were found to be higher in the child with Burkitt lymphoma than in the child's matched controls. This provided clear epidemiological evidence of a causal role of EBV in Burkitt lymphoma in Africa. The results of this study were confirmed when 51 out of 53 cases of Burkitt lymphoma from the whole West Nile District were found to have EBV particles in the tumour cells, while none were present in cases of other tumours.



Guy de Thé, at left, with the field research team in Uganda. IARC epidemiologist Anton Geser is fifth from the left.

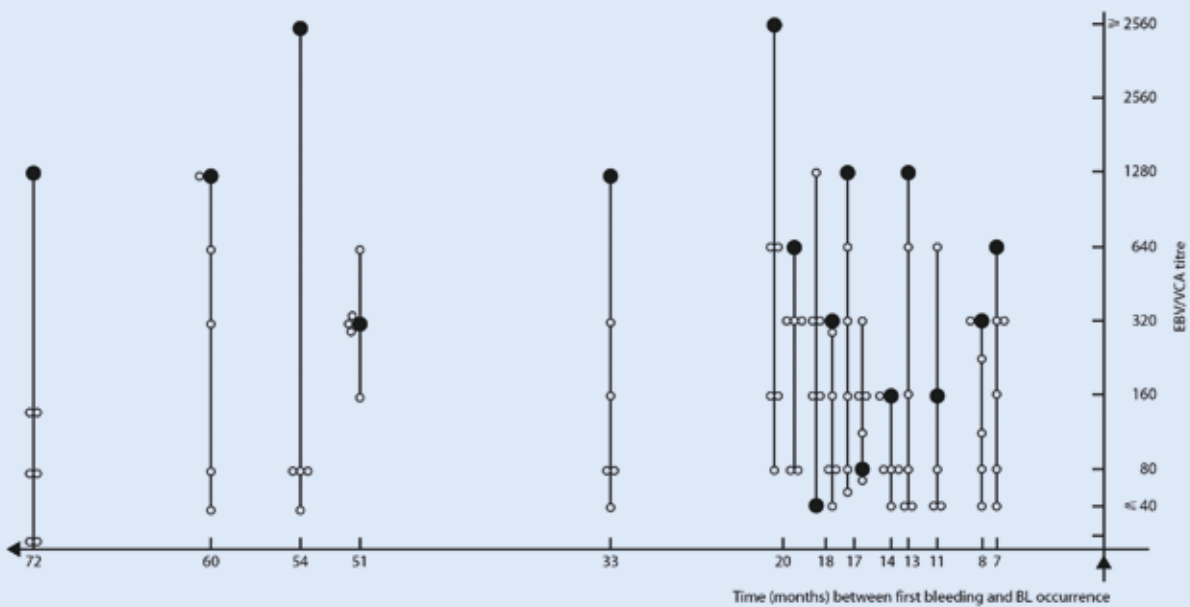

In most comparisons, levels of antibodies against the Epstein–Barr virus viral capsid antigen (EBV/VCA) were appreciably higher in Burkitt lymphoma (BL) cases (filled circles) than in their matched controls (open circles).

Evidence for a major role of EBV in Burkitt lymphoma in equatorial Africa emerged from the West Nile investigation in Uganda. In the meantime, Burkitt lymphoma was reported sporadically from continents other than Africa, but in those cases EBV was found in the tumour cells much less frequently. As was highlighted already in 1985 by the numerous papers in IARC Scientific Publication No. 60, *Burkitt's Lymphoma: A Human Cancer Model*, EBV acts in cooperation with other co-factors: probably impaired immunity due to malaria infection in cases from equatorial regions and multiple other co-factors in cases from other areas, as well as in nasopharyngeal cancers.

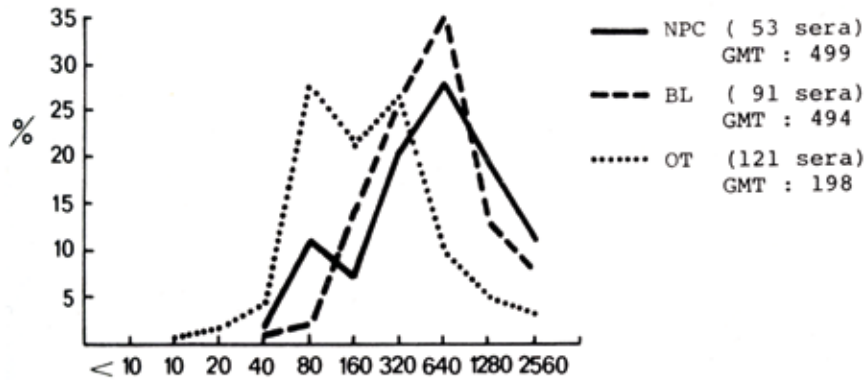

The vertical axis shows the percentage of subjects with different levels of antibodies against the Epstein-Barr virus (EBV), indicated by the numbers on the horizontal axis. High concentrations occur in a larger percentage of subjects with Burkitt lymphoma (BL) or nasopharyngeal carcinoma (NPC) than in subjects with other cancers (OT). GMT, geometric mean titre.

IARC laboratories have continued to study the mechanisms of action of EBV and its interaction with co-factors. Recent contributions have shown the relevance of tobacco smoking and of some genetic variants in nasopharyngeal cancer. In addition, some recent results point to a possible interaction between EBV and aflatoxin, a known carcinogen endemic in the regions where Burkitt lymphoma is commonly found in Africa (see the chapter “Carcinogens in the human environment”). The Working Group responsible for Volume 100 of the IARC Monographs evaluated as sufficient the evidence for the carcinogenicity of EBV for several tumours, including Burkitt lymphoma, Hodgkin lymphoma, non-Hodgkin lymphoma, and nasopharyngeal cancer. Malaria as a co-factor in the etiology of Burkitt lymphoma had been investigated in an IARC study in the United Republic of Tanzania in the late 1970s. In 2012, the Working Group for Volume 104 of the IARC Monographs categorized malaria caused by infection with *Plasmodium falciparum*, the parasite present in highly endemic areas, as probably carcinogenic to humans.

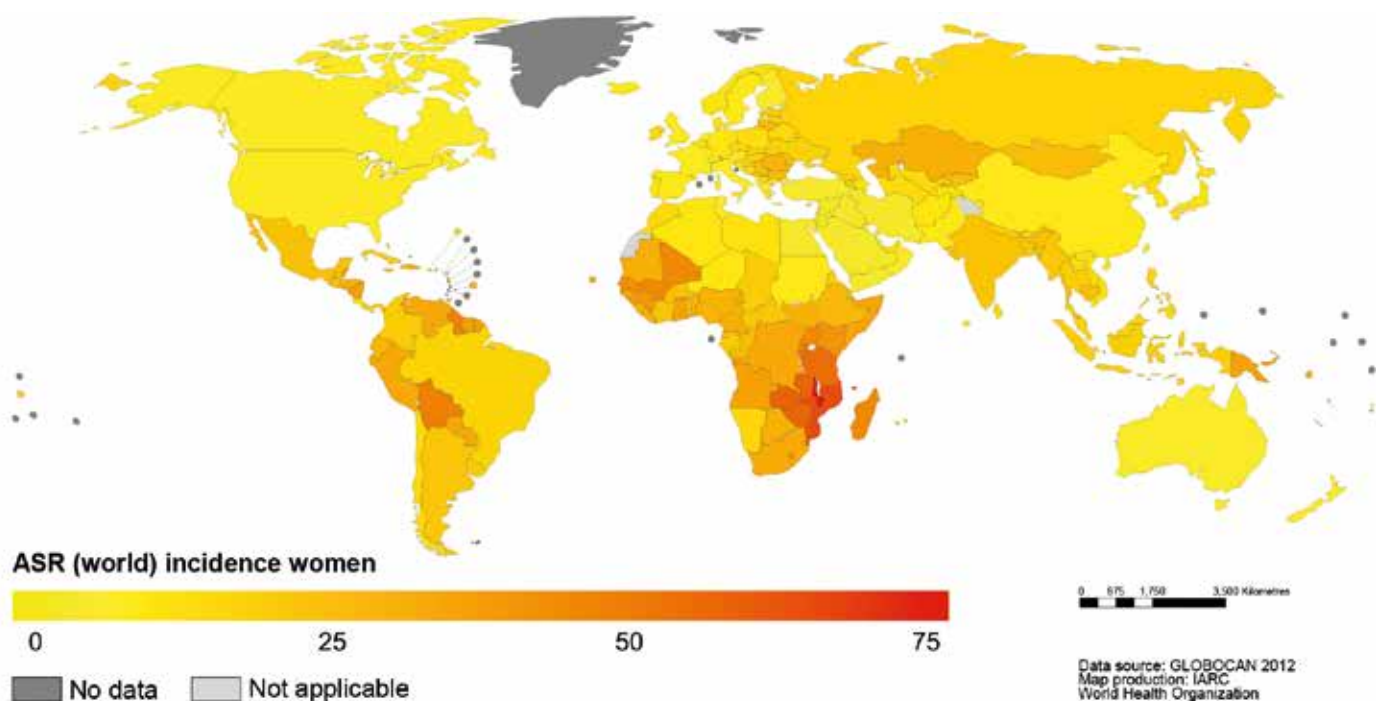

The map shows a large global variation in the incidence of cervical cancer in 2012. ASR (world) is the age-standardized rate (new cases per 100 000 women per year), standardized for age using the world standard population.

The initial focus of IARC scientists on EBV also prompted research on the most frequently occurring tumour in women in developing countries: cancer of the uterine cervix. This tumour was a rather obvious candidate for having an infectious cause. Several studies had documented its association with the number of sexual partners of a woman or her husband. As Richard Doll and Richard Peto wrote in 1981, “The present evidence strongly suggests that one of the primary causes of the disease is an agent passed between partners in intercourse, quite possibly a virus.” At IARC and in other laboratories, tests for EBV were conducted on serum samples of patients and on cervical cancer cells, with disappointing results. These investigations pointed to a need for an expanded search for relevant infectious agents, starting with other herpesviruses already known to be sexually transmissible.

HUMAN PAPILLOMAVIRUSES AND CANCER, ACT ONE

The rhythms of research on cervical cancer at IARC have been marked by two interwoven developments: field epidemiological studies, periodically interspersed with syntheses of the accumulating evidence, including from IARC, on causes of this cancer. A 1989 IARC Scientific Publication already took stock of the changing direction in research, from fruitless efforts on herpesviruses to promising explorations of the role of human papillomaviruses (HPV) (see “1989: Cervical cancer and infection – growing evidence amid much uncertainty”). In several laboratories, considerable advances were made in the understanding of the

molecular mechanisms by which certain types of HPV could transform normal cells into cancerous cells. However, the epidemiology linking HPV to cervical cancer lagged behind.

It is at this juncture that IARC played a key role, mainly through a case–control study involving cervical cancer cases and randomly selected population controls in Colombia and Spain. The frequency of cervical cancer in Colombia was about 8 times that in Spain. Cells from cervical-swab specimens were tested for the presence of HPV DNA. In both countries, the percentage of positivity for HPV was much higher in cells from cases of invasive (i.e. advanced) cancer than in cells from control subjects, and this result was independent of whether the women were sexually active.

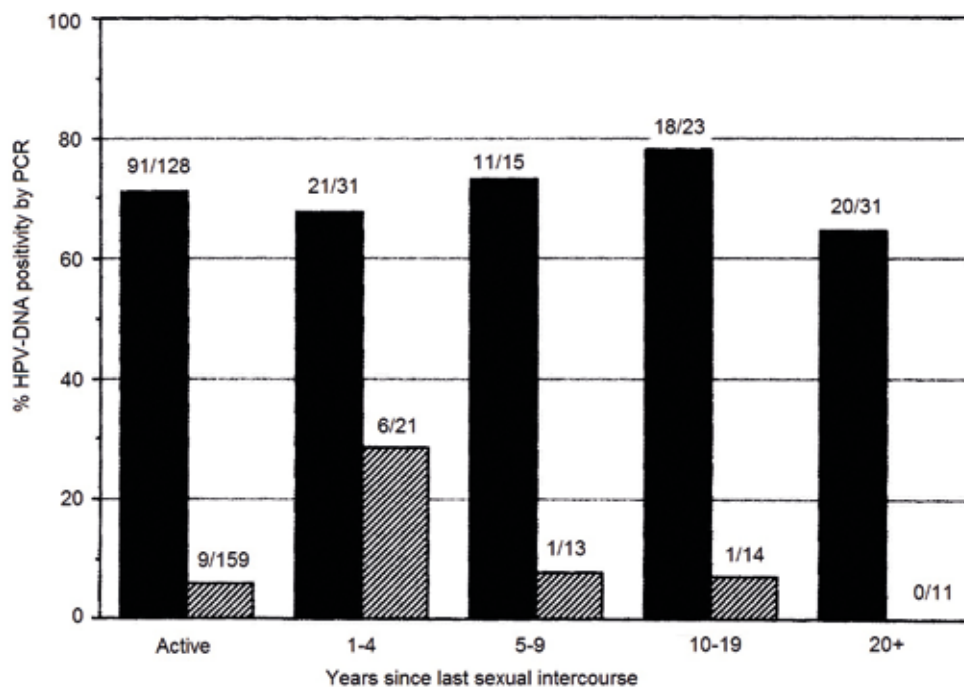

Human papillomavirus (HPV) DNA was measured with polymerase chain reaction (PCR) in cervical cells. The percentage of women testing positive for the presence of HPV DNA was much higher among cervical cancer cases (black columns) than among controls (grey columns), regardless of the time since last sexual intercourse.

A second IARC study was conducted, also in Colombia and Spain, with less advanced cases of cervical cancer (carcinoma in situ). Again, a marked excess of HPV positivity was found among cases compared with controls. The strong association between HPV and cervical cancer, both at an early stage (carcinoma in situ) and at a later stage (invasive cancer), indicated that HPV infection precedes the full development of the tumour, strengthening the evidence for a causal rather than a “passenger” role of the virus.

1989: CERVICAL CANCER AND INFECTION – GROWING EVIDENCE AMID MUCH UNCERTAINTY

IARC Scientific Publication No. 94, *Human Papillomavirus and Cervical Cancer*, was published in 1989. The book's preface concisely summarizes how research trends were evolving at that time: "Although evidence for an association between cervical cancer and sexual activity has been available for over a century, the causal role of a sexually transmitted infectious agent has not yet been proven. For the last two decades attention has been focused on herpes simplex virus type 2 (HSV 2) as the main etiological agent and, although recent studies tend to dismiss this association, it cannot yet be excluded that this virus may play a role. It has only recently become possible to distinguish clearly HSV 2 type-specific antibodies from the closely immunologically related HSV 1 antibodies, and the new methods have yet to be applied in large-scale epidemiological studies.

"In the meantime, attention has shifted to certain types of human papillomavirus (HPV) as prime etiological candidates. The cloning of HPV DNA in bacteria about six years ago and the development of various hybridization methods for routine use have made possible assessment of type-specific exposure to HPV. ... In the light of the continuing debate about the role of HPV in cervical cancer and confronted by practical problems in the conduct of our own epidemiological studies, we decided to convene a small multidisciplinary meeting to evaluate critically the available epidemiological evidence on HPV and cervical cancer and to identify areas in which further epidemiological research is needed."

The volume concludes on a note of encouragement but, even more, of caution: "Current epidemiological studies are expected to provide clear evidence on the association between HPV and cervical cancer (IARC Annual Report, 1985, p. 57). The available data, although suggestive, do not allow further inferences on causality. Epidemiologists embarking on studies in this field should establish close collaboration with molecular biologists and clinicians in order to make the best use of the recent advances in each of these branches of biology and medical science."



Six years after the 1989 IARC publication, the prevailing views on HPV and cervical cancer had changed radically. The Working Group for Volume 64 of the IARC Monographs, *Human Papillomaviruses*, concluded that there is sufficient evidence for the carcinogenicity of HPV types 16 and 18, the subtypes that most frequently infect cervical cells. In 2008, Harald zur Hausen, whose laboratory in Heidelberg produced key experimental evidence on the carcinogenicity of HPV, received the Nobel Prize “for his discovery of human papillomaviruses causing cervical cancer.” The crucial epidemiological demonstration that some HPV types indeed cause cervical cancer in humans earned Nubia Muñoz, the lead scientist of the IARC studies, several prestigious recognitions around the world.



Nubia Muñoz received the Gairdner Foundation's Canada Gairdner Global Health Award in 2009. The award was conferred “for her epidemiological studies that defined the essential role of the human papillomavirus in the etiology of cervical cancer on a global level, which led to the development of successful prophylactic vaccines.” Seen at the awards ceremony are, from left to right, John Dirks, president and scientific director of the Gairdner Foundation, the Ontario Minister of Health, Nubia Muñoz, and the deputy director of the Gairdner Foundation.

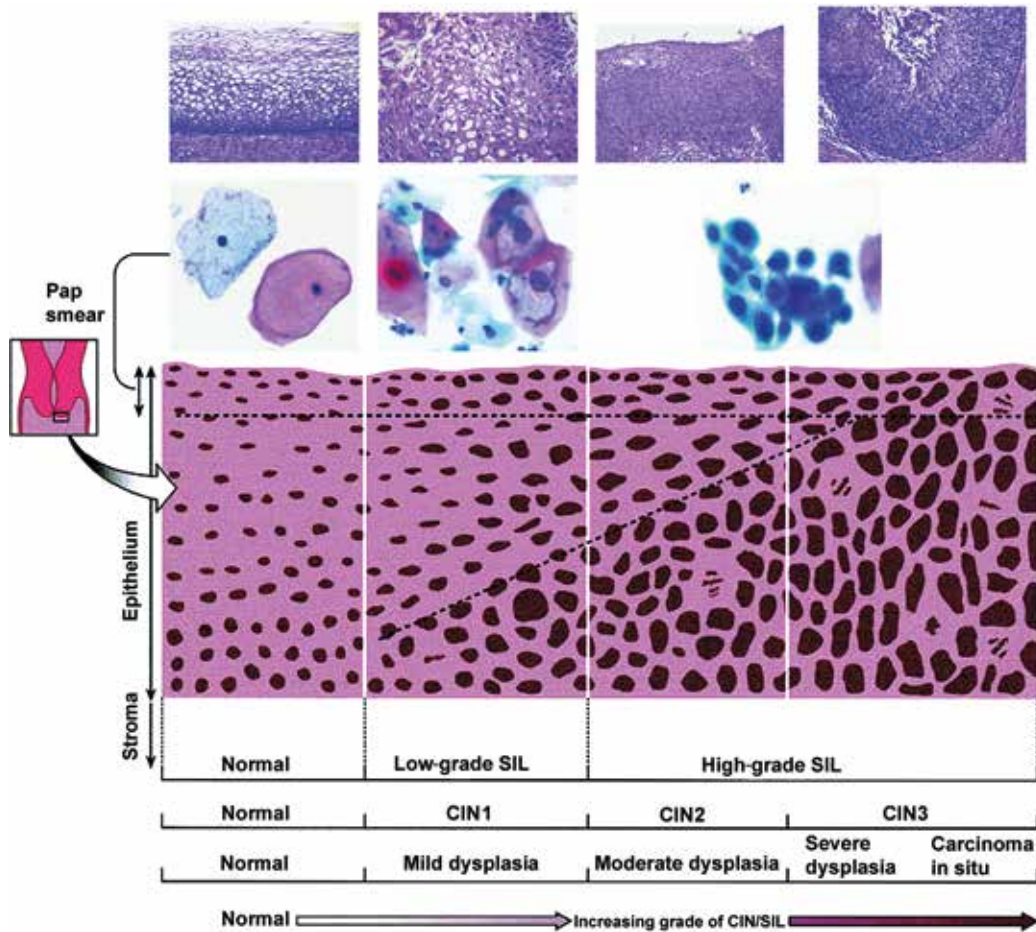

This diagram illustrates the progression from normal tissue of the uterine cervix to carcinoma in situ, the earliest stage of cervical cancer, via a series of steps dependent on the persistence of human papillomavirus (HPV). From top to bottom are shown the microscopic appearance of the tissue, the appearance of the exfoliated cells used for the Pap smear screening test, a schematic representation of the progressive changes in the tissue, and the terminology for the stages of progression (CIN, cervical intraepithelial neoplasia; SIL, squamous intraepithelial lesion).

HUMAN PAPILLOMAVIRUSES AND CANCER, ACT TWO

Establishing that HPV causes cervical cancer opened up entirely new perspectives in research, aimed at preventing the occurrence of the cancer or controlling it through early diagnosis and treatment. The scientific basis for the production of preventive vaccines acting against virus-like particles of HPV had been established during the 1990s, and vaccines approved for use in human populations were made available by the pharmaceutical industry starting in 2006. However, deciding who should be given the vaccine, and when, demanded a thorough knowledge of the natural history of HPV infection. Most sexually active individuals of both sexes acquire HPV infection at some time during their life, but more than 90% of new infections regress over 6–18 months. In the remaining 10% of cases, infection persists, and in some women cells may progress to precursor lesions and ultimately to invasive cervical cancer. To sustain this evolution, other factors (viral, host, or environmental) must play a role. Tobacco smoking is the best-established co-factor, as a result of several epidemiological studies from IARC and other research groups.

Which population should be eligible for vaccination? A study by the International Collaboration of Epidemiological Studies of Cervical Cancer was coordinated by IARC and published in 2012. The results showed that although women can be infected by carcinogenic HPV at any age (with most infections occurring soon after first intercourse), the risk of cervical cancer arising from a new infection falls sharply with age and is very low after about age 40, an indication that vaccination efforts should focus on young people.

Another recent collaborative study, initiated by the United States National Cancer Institute, was conducted in Costa Rica. Healthy women aged 18–25 years were randomized to receive vaccination against HPV types 16 and 18 or vaccination against hepatitis A virus. After 4 years of observation, the HPV vaccine showed a high efficacy in preventing the occurrence of high-grade precursor lesions. A third IARC study used a mathematical model of the transmission of HPV 16 and 18 to investigate the impact of different vaccination options in high-income countries. It concluded that maximizing vaccination coverage of girls is currently the most effective option for decreasing HPV infection of the cervix, rather than aiming at vaccination of boys and girls.

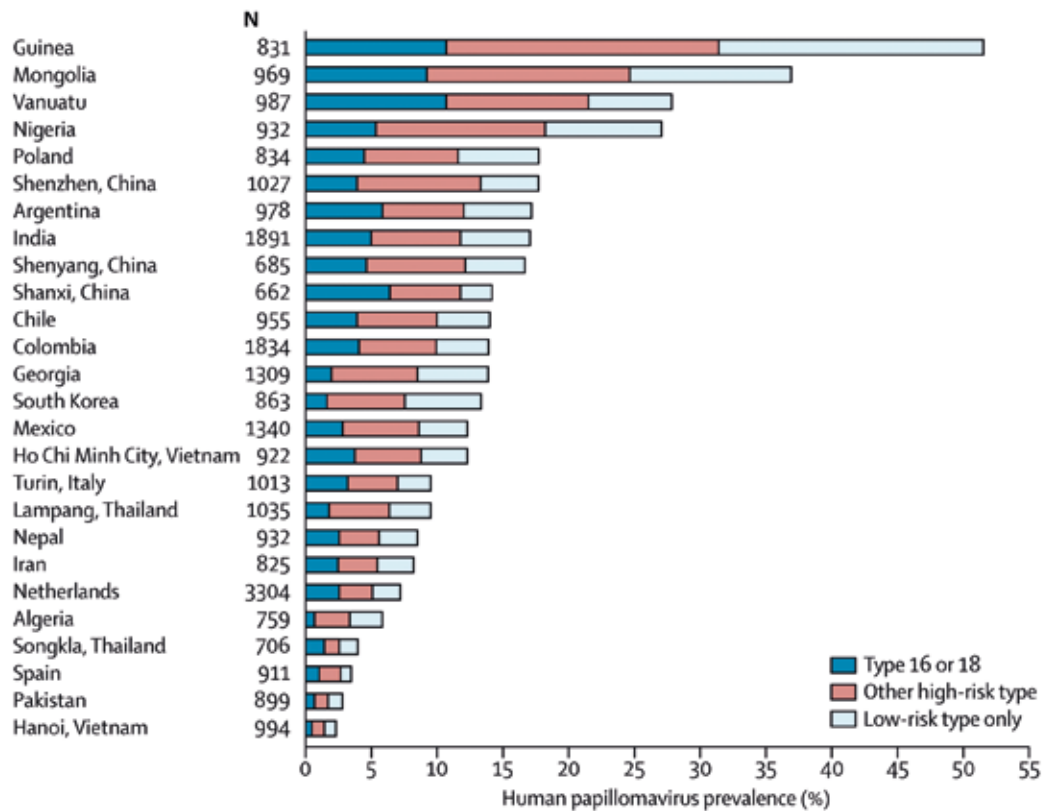

IARC's international surveys of prevalence of human papillomavirus (HPV) infection were carried out from 1995 to 2013 in sexually active women aged 15–59 years. N denotes the number of women tested.

The study in Costa Rica and an ongoing IARC-coordinated randomized trial of HPV vaccine in rural India have shown that two doses of the vaccine are as good as the standard three-dose schedule in providing immunity and preventing infection of the cervix with HPV. This important observation will make implementation of HPV vaccination more affordable and has led to World Health Organization (WHO) support for a two-dose schedule. As the HPV vaccine becomes more affordable, more countries are assessing the potential benefits with regard to cervical cancer prevention for their own populations. One of the pieces of evidence needed for evidence-based policy-making is the prevalence of HPV subtypes in cervical tumours from patients in the country concerned. IARC has helped inform such considerations with its HPV prevalence survey, which uses a standardized protocol and analytical methodology applied to different populations worldwide to provide such information. To date, results are available for 27 populations across the world. The frequency of HPV infection varies widely, from 3% in Spain to 15% in Colombia and to the very high prevalence of more than 50% in Guinea.

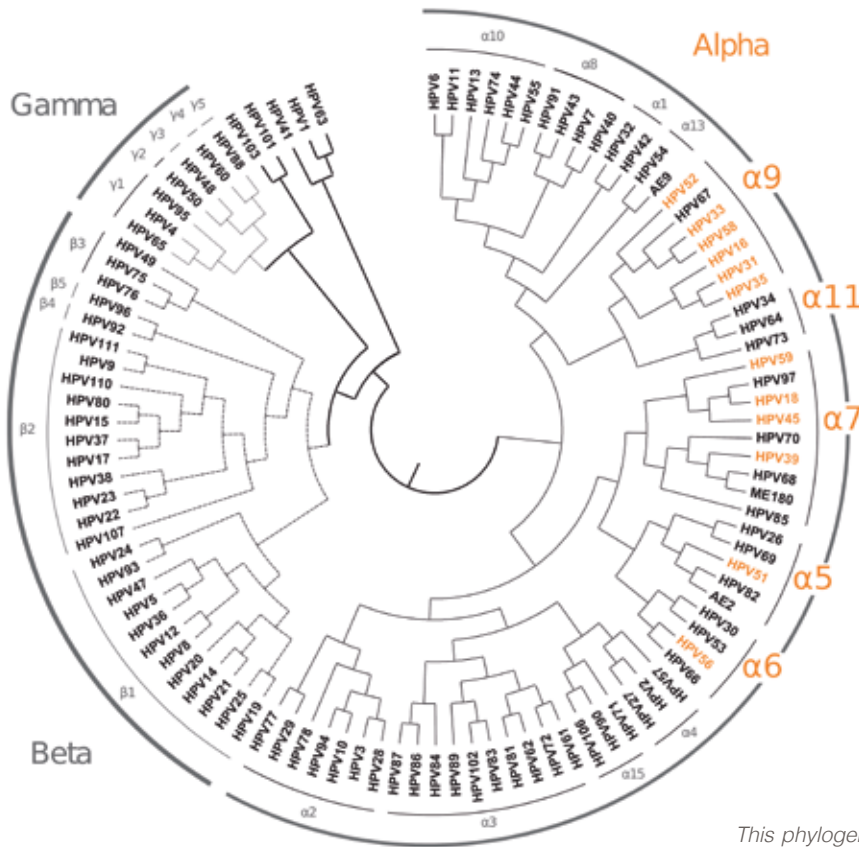

This phylogenetic tree of 100 human papillomaviruses shows how the types are genetically interrelated. The types in the alpha species for which the best evidence of carcinogenicity exists are shown in orange.

Different types of HPV vaccines are commercially available or in preparation. The rapidly increasing availability of these vaccines has not obviated the need for early diagnosis of cervical cancer in unvaccinated women. The Pap smear, the well-established screening method for cervical cancer, may now be preceded or superseded in many countries by testing for the presence of HPV DNA, thus improving the overall quality of a screening programme (see the chapter “Cancer screening and early diagnosis”).

In principle, HPV subtypes other than types 16 and 18 could also be carcinogenic, and organs other than the cervix could also be affected. In 2009, the Working Group for Volume 100B of the IARC Monographs reviewed all the available evidence. As the figure shows, several other subtypes in the alpha species, to which the carcinogenic subtypes HPV 16 and 18 belong, also cause cancer, and in particular cervical cancer. HPV 16 was concluded to cause not only cervical cancer but also cancers of other genital organs (vulva, vagina, penis) and of the anus, oral cavity, oropharynx, and tonsil. A recent IARC study observed wide variations in the proportion of oropharyngeal cancers associated with HPV infection in different populations worldwide. This finding will be important in assessing the future benefits of vaccination on cancers at sites other than the cervix.

IARC scientists are currently studying another family of papillomaviruses, the beta subtypes. The beta species may play a role in skin cancer, where there are, once again, possible interactions with environmental co-factors, such as ultraviolet radiation. Comparisons of the similarities and differences with the alpha subtypes assist in understanding how these and other viruses trigger the development of cancer.

Overall, it is estimated that worldwide, more than half a million new cancer cases per year are attributable to infection with HPV, about the same as the number of liver cancer cases caused by infection with hepatitis B and C viruses. Therefore, HPV infection has been proven to be an important cause of cancer. IARC has been part of the remarkable success story in translating that knowledge into the potential to prevent a substantial proportion of those cases.

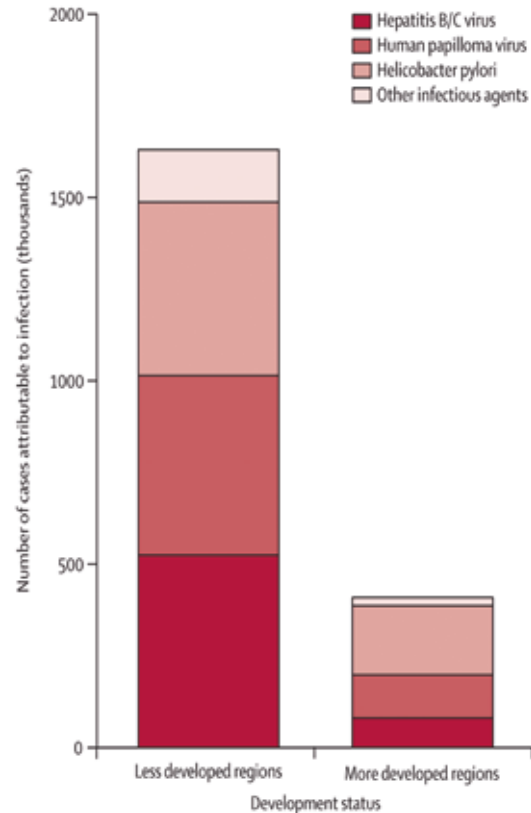

Number of new cancer cases per year attributable to infections, subdivided by infectious agent and degree of development of world regions.

LIVER CANCER

The spark of Burkitt's keen clinical observations on lymphoma, followed by the discovery of EBV, was the first time that there was evidence for the carcinogenicity of a virus in animals and humans. For liver cancer in humans, the identification of causal factors took much longer. The first volume of the IARC Scientific Publications series, *Liver Cancer*, contains the proceedings of a conference held in London in July 1969. The proceedings document the mixture of well-established facts, dubious or fragmentary findings, and mere conjectures that prevailed at the time (see "Liver cancer as seen in 1969"). From the outset, IARC started to take advantage of what was already known to probe the etiology of liver cancer. Several research projects were developed on aflatoxins, experimentally recognized as carcinogens, to investigate their possible role in human cancer (see the chapter "Carcinogens in the human environment").

As soon as reasonably reliable markers of hepatitis viruses, particularly of hepatitis B virus (HBV) infection, became available, IARC epidemiologists led or participated in case-control studies of liver cancer. The results showed a clear association with the HBV markers, and pointed to the role of tobacco smoke as a subsidiary etiological factor. Indeed, by the early 1980s the accumulating evidence from both case-control and cohort studies had shown that the association between HBV infection and liver cancer was strong, specific, and consistent, but was restricted to chronically persistent forms of HBV infection. Most epidemiologists accepted the association as being causal, although substantial proportions of liver cancer did not exhibit the HBV markers.



There was not (and still is not) a vaccine against EBV. Hence, the issue at stake was to test the first anticancer vaccine.
– Christian Trépo, long-term IARC collaborator

The idea rapidly gained ground that a study of subjects vaccinated against HBV would be valuable for several reasons: it would prevent hepatitis B, it would be the acid test of whether HBV was a cause of liver cancer, and – should this prove to be the case – it would prevent the occurrence of this tumour in the population under investigation.

HBV is one of the most common infectious viruses in the world, and vaccines of different types had been available against HBV since 1969. To test the vaccine's effectiveness in preventing liver cancer, a population was required in which HBV infection rates were high and liver cancer was common. Of

the countries in sub-Saharan Africa with these characteristics, The Gambia presented a suitable option. In the mid-1980s, The Gambia had a population of a little more than 1 million people and a reasonable infrastructure.

LIVER CANCER AS SEEN IN 1969

The “working conference” on liver cancer convened by IARC in London in 1969 was chaired by Sheila Sherlock, a leading clinician and researcher on liver diseases. In 1956, Peter Magee had demonstrated for the first time that nitrosamines can induce liver cancers (hepatocarcinomas) in the rat (see the chapter “From laboratory to population”).

In Magee’s conference paper, he noted: “The remarkable differences in cancer incidence in different parts of the world are well known. Primary liver cancer is a notable example of such differences in geographical distribution; it is particularly common in Africa south of the Sahara and, to a lesser extent, among the Chinese in Singapore. ... It thus seems highly probable that the remarkably high incidence of liver cancer in certain areas, especially in Africa, must be the result of environmental factors, often of quite sharply localized geographical distribution. Among the main known causes of cancer – radiation, viruses and chemicals – it seems unlikely that radiation is an important factor. The possible role of preceding viral hepatitis in the etiology of liver cancer has been discussed by Higginson (1963), who concludes that the combined evidence is not convincing. *Furthermore, as yet there appears to be no definitely proven example of a human cancer induced by a virus* [italics added]. The third possibility – namely, the presence of chemical carcinogens in the environment in areas of high liver cancer incidence – must therefore be seriously considered, and this paper is concerned with such a hypothesis. A logical corollary of this hypothesis would be that in areas with populations of similar genetic structure but low liver cancer incidence, the postulated environmental hepatocarcinogens should be absent, or present in much lower amounts.” Magee then went on to review the existing evidence for the carcinogenicity of several environmental carcinogens for liver cancer in humans.

As highlighted by other contributors to the conference, the viral etiological hypothesis was gaining ground. For many years, hepatitis – in particular, the so-called serum hepatitis associated with blood transfusions and reuse of contaminated needles and syringes – had been known to be due to some “filterable” and transmissible agent, probably a virus that had remained unidentified. In 1965, Baruch Samuel Blumberg had discovered an antigen that initially seemed to be genetically determined but soon afterwards was shown to be characteristic of the surface of the newly identified serum hepatitis (or hepatitis B) virus. This antigen, which became known as the Australia antigen since it had first been isolated in the serum of an Australian Aboriginal person, made it possible to investigate the relationship between the virus and liver cancer by measuring several markers of the virus, namely the antigen itself or antibodies secreted against it.

Pulling together the threads from the conference presentations and discussions, the Subcommittee on Priorities in Human Carcinogenic Studies recommended that “priority should be given at this stage to linking already known or suspected carcinogenic factors ... rather than to discovering new factors, because considerable benefits can be reaped from the integration of data from studies already in progress.” In this vein, the subcommittee recommended both case–control and cohort studies to explore the relationship between the presence of the Australia antigen and the occurrence of liver cancer. It also recommended studies investigating the presence of carcinogens such as nitrosamines or aflatoxins, or their metabolites, in the urine of populations known to be at risk of developing liver cancer.



The frequency of infection with the hepatitis B virus (HBV), as measured by the presence of the Australia antigen (HBV surface antigen), shows wide variation throughout the world.

IARC established a multiparty research collaboration – the Gambia Hepatitis Intervention Study – in which it played the leading scientific role, in collaboration with the government of The Gambia, the United Kingdom Medical Research Council (which had a long-established research unit in Fajara, close to the capital city of Banjul), and the Italian government, which provided considerable funds.



A map showing the different regions of The Gambia in West Africa on the two banks of the Gambia River, which flows into the Atlantic Ocean at the Kanifing District. The Gambia Hepatitis Intervention Study covered the whole country, whereas the recently initiated Prevention of Liver Fibrosis and Cancer in Africa (PROLIFICA) study is taking place in the Western Region.

It was known that in The Gambia the highly endemic HBV infection occurs by transmission during childhood, for example in the family or at school. Therefore, a vaccination programme was started in 1986, with a schedule of injections at birth and at the ages of 2, 4, and 9 months. The anti-HBV vaccine was incorporated into the existing Expanded Programme on Immunization recommended by WHO. The original design of the study – a “stepped-wedge” trial – was both scientifically and ethically sound (see the chapter “Innovation in statistical methods”). At the end of the fourth year of the vaccination campaign, two comparable groups, vaccinated and unvaccinated, of more than 60 000 children each had been recruited into the study. A series of logistic problems had to be overcome, including those arising from the staff (at the full complement, more than 80 people) belonging to three different organizations: IARC, the United Kingdom Medical Research Council, and the government of The Gambia. A clear indication of success is the 93% completeness of the vaccination coverage of the targeted population of children.

To follow up the study participants and record the liver cancer cases, the Gambia National Cancer Registry was established in 1986. It has been estimated that results adequate to measure the protective effectiveness of infant vaccination on adult liver cancer will emerge from the comparison of vaccinated and unvaccinated children 30–35 years after immunization, before 2020. Several valuable intermediate results have already

How to measure the outcome (HCC)?

- Established the **Gambia National Cancer Registry** in 1986
- Linking HCC patients with vaccination database
 - Name
 - Sex
 - Year of birth
 - Birth place
 - Names of parents
 - BCG scar
 - Foot & palm prints



Assessing the results of the Gambia Hepatitis Intervention Study involves linking the cases of liver cancer (HCC), recorded by the Gambia National Cancer Registry, with the vaccination database containing the listed items. Vaccinated people will be recognizable by the position of the scar from the antituberculosis bacille Calmette–Guérin (BCG) vaccine – given on the left forearm to people vaccinated against hepatitis B virus and on the right forearm to the unvaccinated – and by comparison of their current foot and palm prints with those taken in childhood.

been gathered, the most important of which is the 94% protection that the vaccine shows against chronic persistence of the virus even 20 years after vaccination, indicating that there is no need for a booster dose in adolescence.



WHO has just reviewed the long-term protection from hepatitis B vaccine, and produced a statement on global policy for whether or not a boost was required, and the only first-rate evidence they had was from the Gambia study. So it is still highly influential in terms of global policy-making. – Andrew Hall, former IARC scientist

Studies showing combined effects of aflatoxin exposure and HBV carrier status have been informative in illustrating the potential benefit of interventions against aflatoxins, particularly for those individuals already chronically infected with HBV and therefore out of reach of the protection afforded by the vaccine. In the same vein, a new study has been started in The Gambia and Senegal. The Prevention of Liver Fibrosis and Cancer in Africa (PROLIFICA) study aims to assess whether antiviral therapy can reduce the incidence of liver cancer in West Africa by identifying and treating chronic HBV carriers before their disease progresses to malignancy.

LEARNING FROM VIRUSES

For research on cancer biology, viruses have proven to be an inexhaustible source of information on mechanisms of carcinogenesis. For instance, the first oncogenes (crucial genes that, when activated, can trigger malignant transformation of the cell) to be discovered were found to result from sequences of viral DNA inserted into the human genome by viruses over the course of evolution.

In the identification of causes of cancer, the discovery of carcinogenic viruses has been the most important breakthrough during the past 50 years, since IARC was established. This discovery was relevant for both science and health. Virally induced cancers represent a substantial burden, particularly in developing countries, and they can be controlled with preventive measures. According to IARC's most recent estimates of the global burden of cancer associated with infections, about 11% of new cancer cases worldwide are attributable to viral infections, and 16% to infections as a whole; in sub-Saharan Africa, one third of all cancers are infection-related. From its earliest years, IARC has made substantial contributions to the advances aimed at reducing this burden.

For IARC, the successes of its research on viral carcinogenesis and on the control of virus-induced tumours illustrate the value of combining three approaches, which reinforce each other. First, field studies that collect original data with the direct involvement of IARC epidemiologists, support from IARC laboratories, and a large international multidisciplinary collaboration facilitated by IARC's standing as a research organization within the WHO framework. Second, periodic authoritative reviews of the evidence pertinent to specific issues of importance in relation to causation and prevention – as have been done for the carcinogenicity of EBV, HBV, hepatitis C virus, and HPV – carried out by international experts under the auspices of IARC as an international agency. Third, an investment in the continuity of long-term research programmes that, although they evolve and adapt over the decades, remain fixed in their commitment to the original objective (see “IARC's long-term research projects in developing countries”).

IARC'S LONG-TERM RESEARCH PROJECTS IN DEVELOPING COUNTRIES

Andrew Hall, now Sir Andrew and emeritus professor at the London School of Hygiene & Tropical Medicine, was the IARC team leader in The Gambia for 5 years when the vaccination programme of the Gambia Hepatitis Intervention Study was initiated. He expresses his views on the value, challenges, and requirements of long-term research projects in a developing country.

“My role was to lead that project in the field. We had a clearly defined, sizeable budget, which came through IARC from the Italian government, and the vaccine was donated by a vaccine manufacturer. We trained all the Gambian health workers, and we introduced in a phased manner the anti-hepatitis B virus vaccine into the routine vaccination programme of The Gambia. In addition, we set up a national cancer registry for the country, in order to provide the means of evaluating the outcome over the coming 35 years.

“The challenge over the long term has been maintaining interest, maintaining the quality of the data, maintaining staff, replacing staff, and of course, for IARC, maintaining a budget. The changes of IARC Directors over such a long period have led to some ups and downs in the project management from Lyon.

“As to the national cancer registry, it has continued to struggle, largely because the health system infrastructure, as in so many low-income countries, is inadequate. ... If you work with these countries, the demand for resources is almost bottomless, and so you have to find ways of doing things that can be managed with the limited resources that the country has.

“IARC has a problem to tackle because the countries that become its members and support it are the wealthier countries of the world, while the countries that need the help the most are the poorest countries. So IARC has to persuade the wealthy countries that the money is taken from them but is spent mostly in the poor ones. I think this is essential for reducing the inequalities we see around the world.

“These projects are important. Things have changed since we began the study in The Gambia. It would not be appropriate today to put expatriates into a country; now, nationals with the pertinent skills should be recruited and one should work jointly with them.”



Andrew Hall, who led the Gambia Hepatitis Intervention Study for IARC from 1986 to 1991.

CANCER SCREENING AND EARLY DIAGNOSIS

Life expectancy

Serious consequences

Improved life expectancy

Reduced serious consequences

Significantly improved life expectancy

Less serious consequences

A

B

C

CANCER SCREENING AND EARLY DIAGNOSIS

Given the vastness of the field of cancer research and the imperative of being at the cutting edge, IARC's activity was from the outset focused predominantly on cancer research for cancer prevention, and – within that domain – on epidemiological and laboratory-based research on cancer-causing agents as a route to primary prevention. In addition, some topics of investigation were developed in the area of early diagnosis of cancer precursor lesions, i.e. secondary prevention, in particular for cancer of the uterine cervix. The importance of early – or, at the very least, timely – diagnosis of cancers common in developing countries

with scarce medical facilities quickly became clear. Thus, more IARC research was channelled into these countries. Projects on early detection combined the advancement of scientific knowledge with the development and strengthening of local infrastructures for diagnosis and treatment.

In the early 1980s, IARC conducted a pilot project: a moderately sized preventive trial in a population with a high frequency of oesophageal cancer, in Henan Province in China. No effect could be demonstrated of vitamin and zinc dietary supplements on detectable precursor lesions of oesophageal cancer. In the mid-1990s, IARC also investigated the effects of vitamin A and β -carotene dietary supplements on oral leukoplakia, a precursor lesion for oral cancer, in a small-scale trial among fishermen and women in India.

Evidence of remission of lesions indicated the value of conducting longer-term trials with vitamin A supplementation. In parallel with these activities and early work on cancer screening, IARC initiated the Handbooks of Cancer Prevention, as well as other evaluative reviews, which included several screening programmes.

CERVICAL CANCER SCREENING

In developed countries

In the past 50 years, cervical cancer incidence and mortality have dropped markedly in most developed countries, which is where the first clear evidence of the effectiveness of screening for cancer emerged.



I was with the first delegation of IARC going to a very remote area of rural China for two to three months, and we were the first foreigners to go there. We probably did what were the first intervention studies trying to prevent precancerous lesions with vitamins. – Nubia Muñoz, former IARC scientist

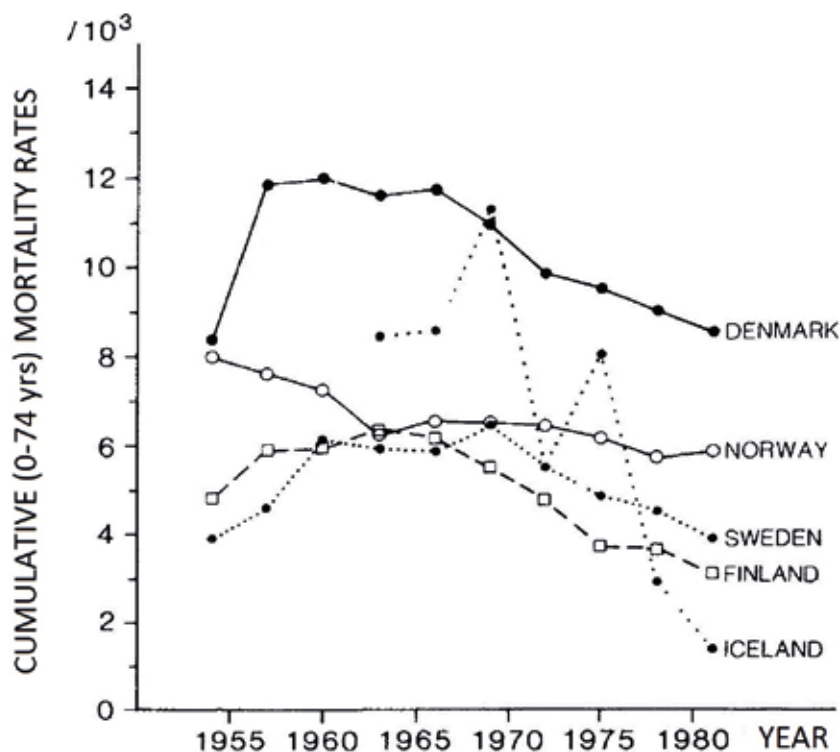

Trends in the cumulative mortality rates (ages, 0–74 years) from cervical cancer in the Nordic countries. Between 1965 and 1982, the mortality decreased in all five countries. Apart from the introduction of the screening programmes, there had been no other major changes in the health care systems since the mid-1960s that would appreciably affect mortality from cervical cancer. After 1965, mortality fell by 84% in Iceland, by 50% in Finland, and by 34% in Sweden; these three countries had organized nationwide screening programmes. Mortality fell by 27% in Denmark, where the screening programme was introduced in some counties, and by 11% in Norway, where there was an organized programme in only one county.

A clinical diagnosis of cancer is confirmed once the microscopic examination of tissue specimens has shown the histological features characteristic of a malignancy. The microscopic examination of exfoliated cells from the tissue also provides information, and George Papanicolaou first suggested, in 1928, that this could prove valuable for early diagnosis of cervical cancer. By the 1940s, the feasibility and simplicity of the cytological examination of the cervix, or “Pap smear”, had been established in the USA. As Michael Shimkin noted, “Since the procedure does recognize an important cancer before it is invasive, its full application would significantly reduce mortality from cervical cancer.” The logic of this argument seems unassailable, and – moving beyond cervical cancer to other malignancies as well as other diseases – it has become the rationale for all attempts to recognize and treat a disease in its early stages (see “Screening for cancer: theory and reality”).

The effectiveness of Pap smear screening was supported by a collaborative analysis by scientists at IARC and in Finland of the trends in mortality from cervical cancer in the Nordic countries. By 1980, more than three quarters of women had undergone screening in all five countries (Denmark, Finland, Iceland, Norway, and Sweden). Between 1953 and 1982, cervical cancer mortality stopped rising and started to fall in all five countries, accompanied since the mid-1960s by a decrease in the occurrence of new clinical cases.

SCREENING FOR CANCER: THEORY AND REALITY

The figure depicts the clinical history of a person developing a cancer that is diagnosed under three different circumstances, corresponding to different time points in the natural course of the disease. In circumstance A, the diagnosis is made because of the appearance of symptoms, i.e. when the disease is in its clinical phase. There is usually a delay between the appearance of symptoms and the start of treatment of a cancer. The person's life expectancy after the treatment may, even today, be fraught with unpleasant consequences because of possible complications of the disease and side-effects of treatment. In situation B, earlier diagnosis (during the clinical phase) and treatment are possible due to better awareness of symptoms by the patient, the patient's close relatives, and the physician. This may lead to some increase in life expectancy and some reduction in serious consequences of the disease. In circumstance C, the cancer is recognized before symptoms appear, i.e. in the preclinical phase, when it is detectable by screening tests (which always need to be confirmed by a full diagnostic work-up). The earlier detection and treatment may result in an appreciably longer life expectancy, with less serious consequences of treatments because they may be applicable in less drastic forms to the initial stage of the disease.

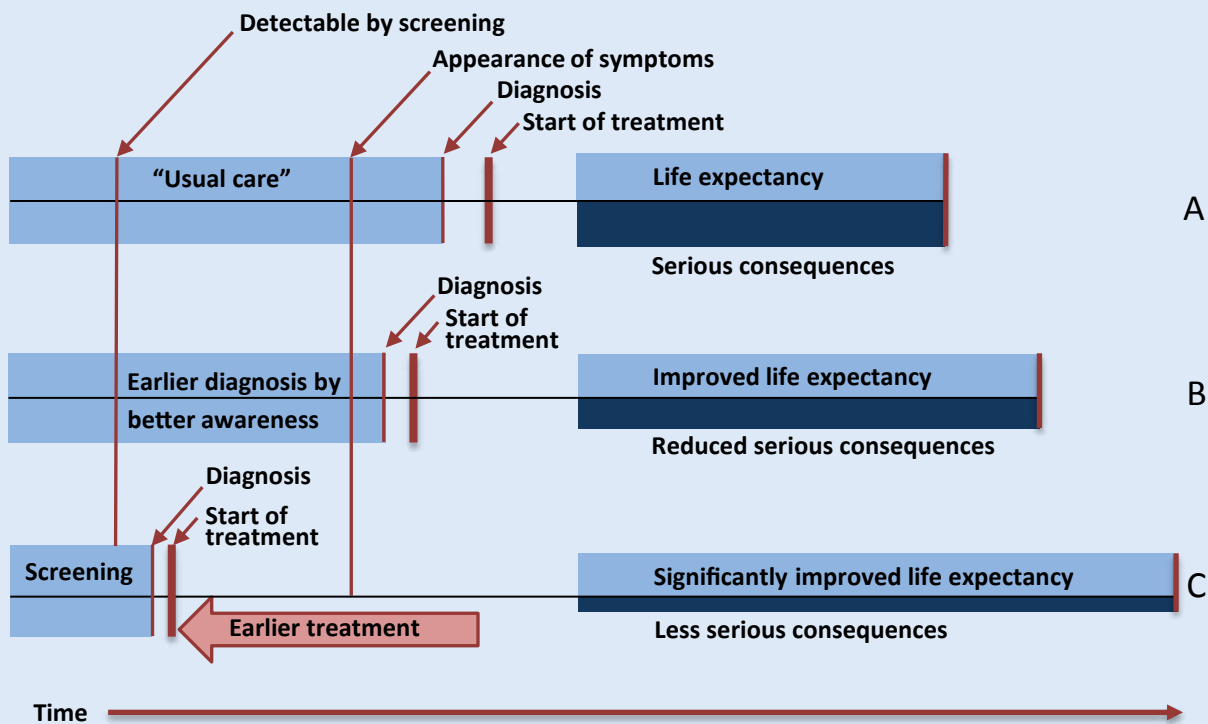

Early detection of cancers through symptoms or by screening.

In theory, situation C makes sense biologically and clinically, but does it actually occur when a screening programme is systematically offered to a population? What if the sole result of earlier detection and treatment is that a person lives a longer time as a recognized cancer patient but not a longer life? These questions can be rigorously addressed only by epidemiological studies in which subjects are assigned at random either to undergo scheduled periodic screening for, say, cervical cancer or to simply be followed up according to standard local

medical practice. A cervical cancer screening programme would be demonstrated to be effective if mortality from cervical cancer were lower in the screened group than in the unscreened group. An evaluation trial of this kind, involving thousands of people over several decades, poses complex organizational challenges and requires considerable resources. However, such trials have been conducted on various screening programmes for cancers of the breast, ovary, colon and rectum, lung, and prostate. No such trial has ever been carried out for screening of cervical cancer because the widespread acceptance of the Pap smear among doctors and women alike made it ethically unacceptable to conduct a study in which the test would deliberately not be offered to a group of women.

IARC Scientific Publication No. 76, *Screening for Cancer of the Uterine Cervix*, was published in 1986 as a joint initiative of IARC and UICC. The papers collected in this publication provide detailed information on the screening programmes in the Nordic countries and other countries, and review the evidence on the effectiveness of the programmes. Optimal ages and frequency for screening are also discussed. By the mid-1980s, a clear consensus prevailed, based on epidemiological studies of the observational type but without any evidence from randomized trials, that programmes of systematic screening using the Pap smear test are effective in reducing occurrence of cervical cancer and mortality from the disease.

IARC was involved in really important publications that became landmark papers on the evaluation of cervical cancer screening, proving very important for the next 20 years.
– Max Parkin, former IARC scientist

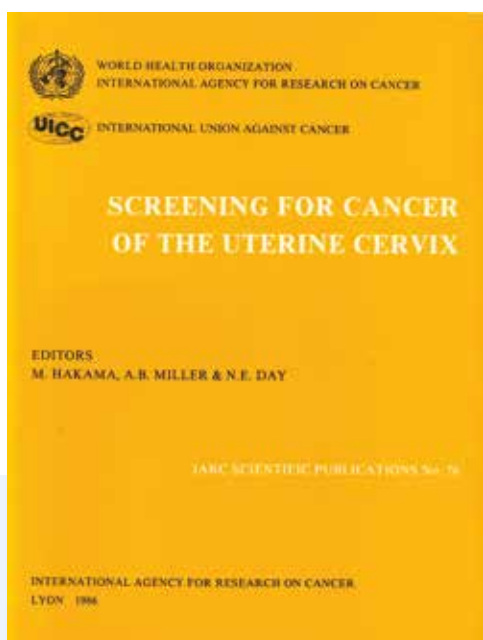

In developing countries

Over several decades, population-based cervical cytology screening programmes offering the Pap smear test to women every two to four years have reduced cervical cancer incidence and mortality by up to 80% in the developed countries of Australia, Japan, and New Zealand, as well as those in Europe and North America. However, of the more than half a million new cases of cervical cancer each year worldwide, 85% occur in developing countries. It is in these areas that a majority are diagnosed at an advanced stage, and in parts of Africa, Asia, and Latin America, 5-year survival rates for cervical cancer frequently fall below 50%.

In low-income countries, screening programmes are often non-existent, and in middle-income countries they have often performed poorly. Introducing and maintaining a high-quality Pap smear service for a large population is challenging. Moreover, women with an abnormal test result should usually receive a confirmatory diagnosis through microscopic examination of a biopsy specimen by a histopathology specialist – a service that is often unavailable in low-resource settings. The recognition of these limitations for cervical cancer screening in low- and middle-income countries has led to the development of alternative, simpler screening methods.

Women at a health centre in India waiting to receive cervical cancer screening.



IARC has provided impetus to these endeavours through an approach that has combined research on the performance of alternative methods with the establishment and consolidation of the health services needed for large-scale application (see “Research projects linked to health services development”). A major IARC collaborative investigation involved more than 130 000 women aged 30–59 years living in 497 villages in one district in the western state of Maharashtra in India. The villages were randomly allocated to four different intervention procedures; all the women in a village received the same procedure. The women were followed up for at least 8 years to record occurrence of cervical cancer and mortality from the disease.

When the four procedures were compared after 8 years, the best outcome was seen for screening by testing for the presence of human papillomavirus (HPV) DNA (see the chapter “From laboratory to population”). The next best outcome was for the simplest of the four procedures: visual inspection of the cervix with acetic acid. In this technique, the cervix is examined by colposcopy (inspection of the vagina and cervix using magnifying lenses) after acetic acid is applied with a cotton swab. If an abnormal aspect of the cervical surface is found, a full colposcopy examination is carried out to identify precancerous lesions. These can be treated immediately by cryotherapy (freezing cervical tissue with nitrous oxide), as in the study in India, or alternatives such as cold coagulation or a loop electrosurgical excision procedure.

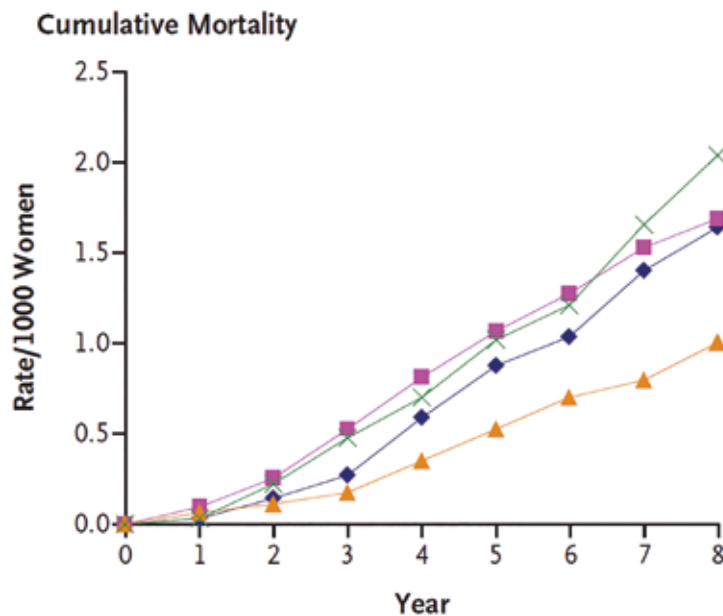

Cumulative mortality rates from cervical cancer over 8 years of follow-up in a screening study in rural India. The lowest mortality was seen in women screened by testing for human papillomavirus (HPV) DNA (yellow triangles). The next best intervention was visual inspection of the cervix with acetic acid (blue diamonds). Less favourable was the mortality of women screened by cytology (violet squares) and of the control group, who did not receive any specially programmed screening (green crosses).

RESEARCH PROJECTS LINKED TO HEALTH SERVICES DEVELOPMENT

Most IARC research projects on the evaluation of cancer screening in developing countries are also designed to be instruments for local development of regular health services, in a similar way to the vaccination project against hepatitis B virus in The Gambia (see the chapter “Viruses and vaccines”). Rengaswamy Sankaranarayanan comments on this hallmark of IARC field research.

“We wanted the research to be a vehicle, not only to address a research question but also for our project afterwards to develop into a service programme for early detection. It creates a lot of interest for the local people to continue the early detection activity, drawing in more people and acting as a catalyst to develop wider early detection programmes in the region and in the country. Being a clinician, I was well aware of the relevance of early detection for successful treatment. Hence, wherever we mounted a research project we looked at it in a comprehensive way, addressing the research question as well as the practicalities of how to train people in diagnosis and treatment in order to improve the local cancer control facilities.

“For these purposes, we made optimal use of the position of IARC as a research organization within the framework of the World Health Organization (WHO), with its links to national governments and health services authorities. We had the double advantage of being perceived and treated as belonging to a research institution with recognized high academic standards that at the same time has a public health role as a WHO agency.

“IARC has become much more visible in several developing countries because of the approach of combining research with health services development. Detecting cancer when it is still asymptomatic or soon after people have symptoms gives immediate visibility to those carrying out the detection and treatment programme. In the case of cervical cancer, we have been the main exponents of the single-visit approach, where screening, diagnosis, and treatment are all done on the same day. Maybe this will lead to more low- and middle-income countries calling on IARC to contribute on the basis of its successful experiences in the development of uniform control policies for cancers.”

Such “see-and-treat” interventions, where screening, diagnosis, and treatment are all performed in a single session, can be especially valuable to ensure compliance in rural settings, where women may have to travel long distances to reach modestly equipped health centres. In view of its feasibility and affordability, the “screen-and-treat” approach based on visual inspection of the cervix with acetic acid has been tested for wide implementation in numerous countries, including some in Asia (Bangladesh and Thailand) and in Africa

(Angola, Burkina Faso, the Congo, Guinea, Mali, the Niger, and the United Republic of Tanzania). Notably, IARC has been instrumental in providing

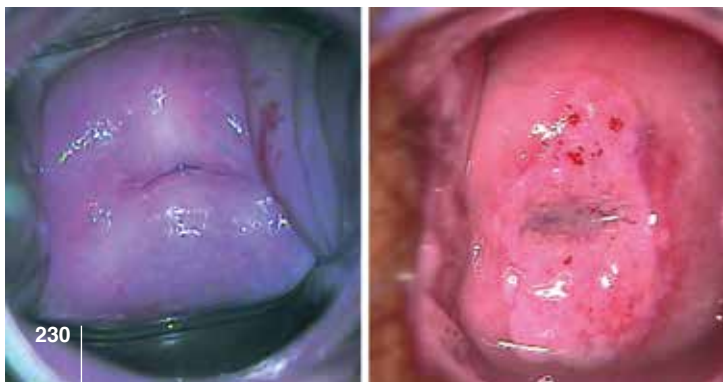

Outcomes of visual inspection of the cervix with acetic acid. There is a marked difference in appearance between a normal cervix (left) and one with a lesion suggestive of cervical intraepithelial neoplasia, an early stage of cervical cancer.

training to health care professionals in this approach, and thus has been able to translate the research through to adoption in such settings.

ORAL CANCER SCREENING

About 300 000 new cases and 150 000 deaths from oral cancer occur each year worldwide. Two thirds of these occur in developing countries, and one third in the Indian subcontinent, where oral cancer is the most common malignancy in men. This high risk is related to the high frequency of chewing mixtures containing agents that have been classified as carcinogenic by the IARC Monographs Programme. If the cancer is not detected and treated at an early stage, the 5-year survival rates are low (40% or less). Oral cancer is thus an obvious candidate for screening, given that the oral cavity is easily accessible for inspection.

A large IARC-coordinated randomized trial testing the visual screening of oral cancer was conducted in the state of Kerala, at the south-western tip of the Indian subcontinent. The trial involved almost 200 000 men aged 35 or older belonging to 13 local populations. Seven of the populations were assigned to three rounds of visual screening over an 8-year period. The other six populations represented the control arm of the trial, assigned to the standard health care prevailing in Kerala. The visual examination was performed by university graduates in non-medical subjects who had been trained to recognize lesions that could be precancerous or cancerous. Screening followed by referral for treatment was shown to reduce mortality from oral cancer, particularly among men at high risk because of tobacco use and/or alcohol consumption; for this group there was a 30% reduction in oral cancer mortality rate compared with the control group. For these men at high risk, when all the costs incurred by the screening programme were added up, the cost increase over the standard care as provided in Kerala amounted to about US\$ 150 per year of life saved, which is not an unreasonable cost even in a moderate-resource setting.

COLORECTAL CANCER SCREENING

Cancer of the colon and rectum is the third most common cancer globally, and its incidence is increasing in many developing countries. In fact, incidence of colorectal cancer increases in conjunction with improvements in the level of human development worldwide. Early detection and removal of adenomatous



In the Indian subcontinent, many people enjoy chewing paan, a mixture containing betel leaf combined with lime, areca nuts, and sun-cured tobacco.



Visual examination of the colon mucosa enables not only the recognition but also the removal of cancer precursor lesions like polyps. The magnified image at lower right shows a bowel polyp being clasped for excision. Assessing the needs and building the capacity for clinical diagnosis and treatment is a crucial part of the implementation of a successful programme.

(glandular) polyps has been shown to be effective in developed countries. There is a need to implement programmes of screening plus treatment in developing countries, preferably in advance of the projected increases in incidence of the disease.

IARC has started to support the establishment of such programmes, and very recently results have become available of a large pilot implementation project in Thailand. The study, conducted by researchers from IARC and the National Cancer Institute in Thailand, involved a target population of nearly 130 000 adults aged 50–65 years in Lampang Province. The faecal blood occult test was used as the screening instrument, followed by colonoscopy in people with occult blood in the faeces. Polyps seen at colonoscopy were removed during the examination, and suspected cancerous lesions were referred for further investigation and treatment according to standard protocols.

The study was carried out in real-world conditions using the existing routine health care facilities in Lampang Province. The preliminary results documented the feasibility, acceptance, and safety of the procedures of an organized screening programme to which people are invited and in which a high proportion participate. Observations included higher participation rates in rural areas than in urban areas and among women than among men. These findings were used in the subsequent scaling up of the programme to other provinces. It is notable that the integration of a research study within a national programme in this way is efficient, adding value for modest additional cost.



A major challenge to implement change, when you have found the resources, is that you need the health service capacity, a health service infrastructure to deliver what you want to deliver in an efficient manner.

– Rengaswamy Sankaranarayanan,
IARC scientist

THE IARC HANDBOOKS OF CANCER PREVENTION

The first volume of the IARC Handbooks of Cancer Prevention was published in 1997 and dealt with non-steroidal anti-inflammatory drugs (NSAIDs), consistent with a view at the time that chemoprevention could provide a valuable approach for cancer control. The express purpose of the Handbooks, as a complement to the IARC Monographs, was to evaluate scientific information on agents and interventions that may reduce the incidence of or mortality from cancer. The Handbooks were developed with their own Preamble, which defined the procedures for evaluating chemopreventive agents, a scope later enlarged to cover evaluation of other types of preventive interventions, including primary prevention and cancer screening.

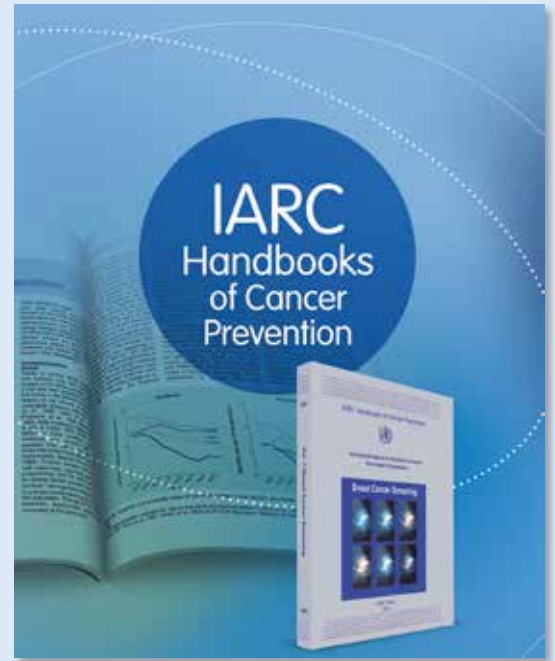

To date, the Handbooks have covered topics such as preventive agents (e.g. NSAIDs, vitamin A, carotenoids, and retinoids), preventive actions (e.g. use of sunscreens, weight control and physical activity), screening (cancers of the breast and cervix), and various tobacco control measures. The Handbooks were relaunched in 2014, and the first in the new series was a reassessment of breast cancer screening. Volumes on screening for cancers of the cervix (update) and cancers of the prostate, lung, and colorectum (first-time evaluations) are foreseen.

The overall intention of the Handbooks is to assist national and international authorities in devising programmes of health promotion and cancer prevention and in assessing the benefits and risks of a particular intervention. There is a major demand worldwide for such evaluations in order to improve public health; IARC is ideally placed to respond based on its expertise, experience, reputation, and independence.

REVIEWING THE EVIDENCE ON SCREENING PROGRAMMES

The IARC Handbooks of Cancer Prevention series evaluates the evidence for preventive interventions (see the chapter “Carcinogens in the human environment”). Volume 7 of the series, published in 2002, evaluated breast cancer screening. The Working Group responsible for that volume concluded that there was sufficient evidence from randomized trials for the efficacy of screening women aged 50–69 years by mammography as the sole screening modality in reducing their mortality from breast cancer. However, the Working Group formulated several qualifications, in particular concerning the substantial uncertainty about the best frequency of screening and the adverse effects, given the fact that 50–90% of women found positive at the mammographic test would turn out not to have breast cancer upon completion of the confirmatory diagnostic procedures. Subsequently, debates about these open issues became more heated after the statistical reanalyses of data from the available studies.

CLINICAL BREAST EXAMINATION: IS IT EFFECTIVE?

Organized mammography screening is often neither affordable nor feasible in low- and middle-income countries, where breast cancer incidence and mortality are now rising. In such countries, a more feasible proposition is clinical breast examination (visual inspection and palpation by a skilled health worker). IARC has addressed the issue of evaluating its effectiveness through a collaborative study in the state of Kerala in India.



Clinical breast examination by trained health workers may offer a viable alternative to mammography-based screening.

More than 110 000 women aged 30–69 years with intact breasts and no history of breast cancer participated in the study. Depending on their electoral ward of residence (each ward formed a cluster of women), they were randomly assigned to the screening intervention or to standard health care. The clinical breast examination was performed by female health workers with a bachelor's degree who had undergone a 3-week structured training course. The health workers provided the examination, which took on average 6–9 minutes, to women in their homes, at a nearby health centre, or in a makeshift clinic in the area. Women found positive at the clinical breast examination because of suspicious findings were referred to a breast clinic set up at the screening project office for further investigation; if breast cancer was confirmed, they underwent treatment.

Three rounds of screening some years apart were planned. After the first round, the screened group showed a higher frequency of early-stage breast cancer than the control group and a slightly lower frequency of advanced breast cancer. Although these results are consistent with a favourable effect of screening, a firm evaluation – particularly in terms of mortality – will become available only after the completion of the three rounds of screening.

In 2014, the IARC Handbooks of Cancer Prevention programme resumed when a Working Group was convened to re-evaluate the evidence on breast cancer screening (see “The IARC Handbooks of Cancer Prevention”). The Working Group's key conclusion – using the codified IARC criteria and language – was that there is sufficient evidence of a reduction of breast cancer mortality by mammography screening in women aged 50–74 years and that there is sufficient evidence that screening induces overdiagnosis of cancers (i.e. cancers detected by screening that would not otherwise have been diagnosed during a woman's lifetime). An obvious implication is that the balance of benefits and harms needs to be assessed carefully for each population, as characterized in particular by the frequency of breast cancer and the health resources available. The Working Group concluded that there is sufficient evidence that mammography

screening for women aged 50–69 years can be cost-effective in countries with a high frequency of breast cancer. Results on mortality reduction by modalities other than mammography-based screening were considered to be inconclusive (see “Clinical breast examination: is it effective?”).

Over the years, IARC has provided its expertise in the preparation of World Health Organization guidelines for the screening and treatment of precancerous lesions to prevent cervical cancer and breast cancer. In addition, the findings from IARC research studies have contributed to the evidence base for the development of those guidelines, notably for cervical cancer. IARC has also made a major contribution by coordinating the European Cancer Network for Screening and Prevention in providing European guidelines for quality assurance in cervical, breast, and colorectal cancer screening. These guidelines have been highly influential in the development of national screening programmes across the European countries. Furthermore, in 2014 IARC coordinated the development of the fourth edition of the European Code Against Cancer, which consists of 12 recommendations. These “12 ways to reduce your cancer risk” focus on actions that people can take to lower their risk of cancer, including undergoing screening tests for cervical, breast, and colorectal cancers.

The website of the IARC Screening Group (screening.iarc.fr) offers a comprehensive overview of IARC’s activities in the area of early detection and treatment of cancer, including training materials, scientific papers, field operating manuals, and guidelines for interventions.



The screenshot displays the IARC Screening Group website. At the top, the title "IARC Screening Group" is shown with the URL <http://screening.iarc.fr>. Below the title is a horizontal strip of images depicting various people and activities. The main content area is divided into several sections:

- Online documents:** A grid of icons representing different types of resources: Training materials, Digital learning series, Planning guides, Technical reports, Fact sheets, Selected papers, Audio presentations, Presentations, and Movies.
- Screening & vaccine topics:** A list of topics with corresponding icons and brief descriptions:
 - Cervical cancer:** visual inspection, VIA, VILI, colposcopy, pap-smear, cytology, histology, project planning guidelines, LEEP, cryotherapy, current research projects, major studies, START project, multinational cross-sectional studies, cervical cancer screening projects directory, training documents.
 - HPV vaccine:** randomized trial 2 vs 3 HPV vaccine doses, online HPV documents.
 - Oral cancer:** early diagnosis of oral neoplasia, physical examination, biopsy, cytology, FNAC, anatomy, current research project, TOCS project.
 - Breast cancer:** breast-self examination, clinical examination, early detection, research studies.
 - Colorectal cancer:** publications.

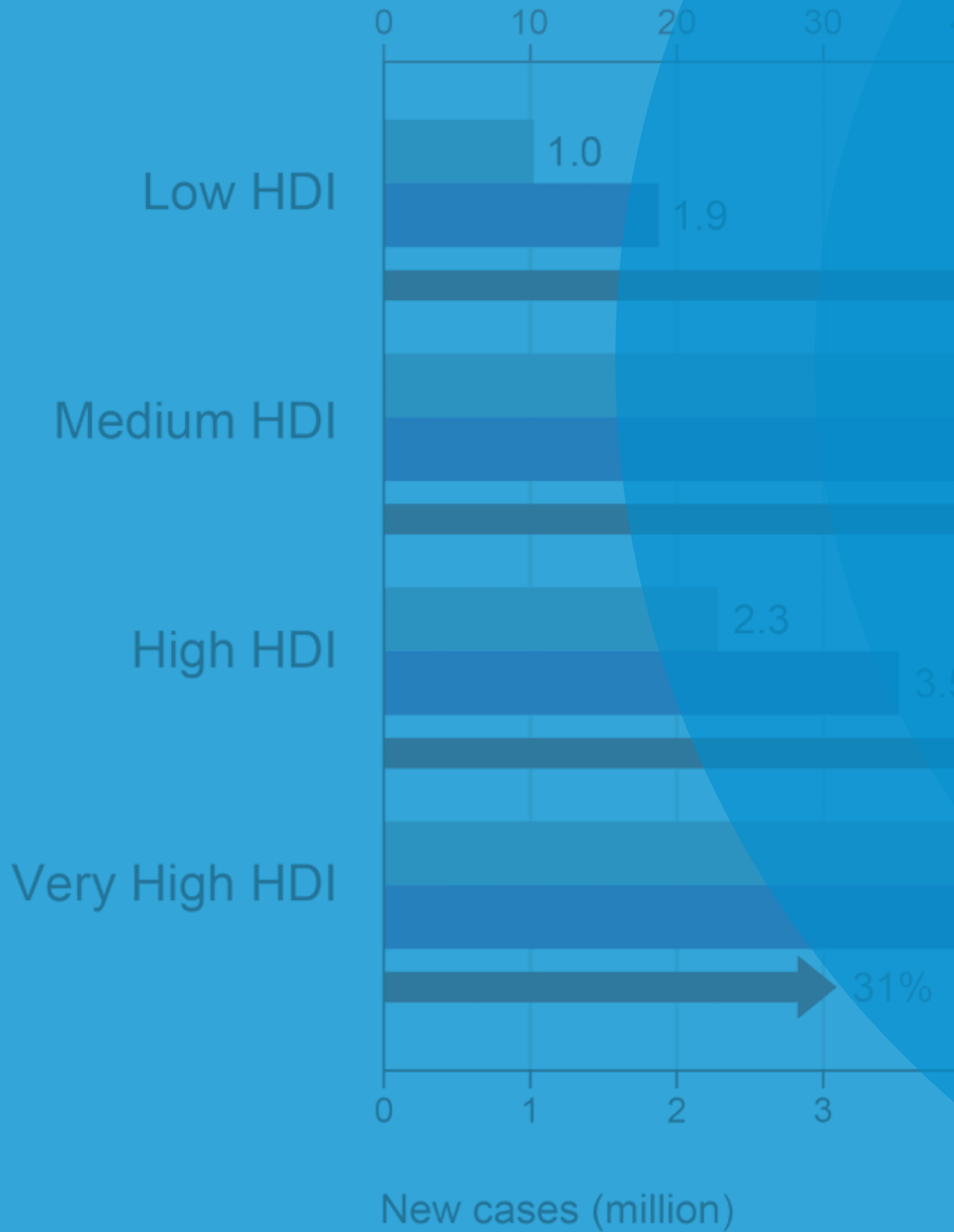

increase 2015-2035

40 50 60 70 80 90 100

IARC: THE SECOND 50 YEARS

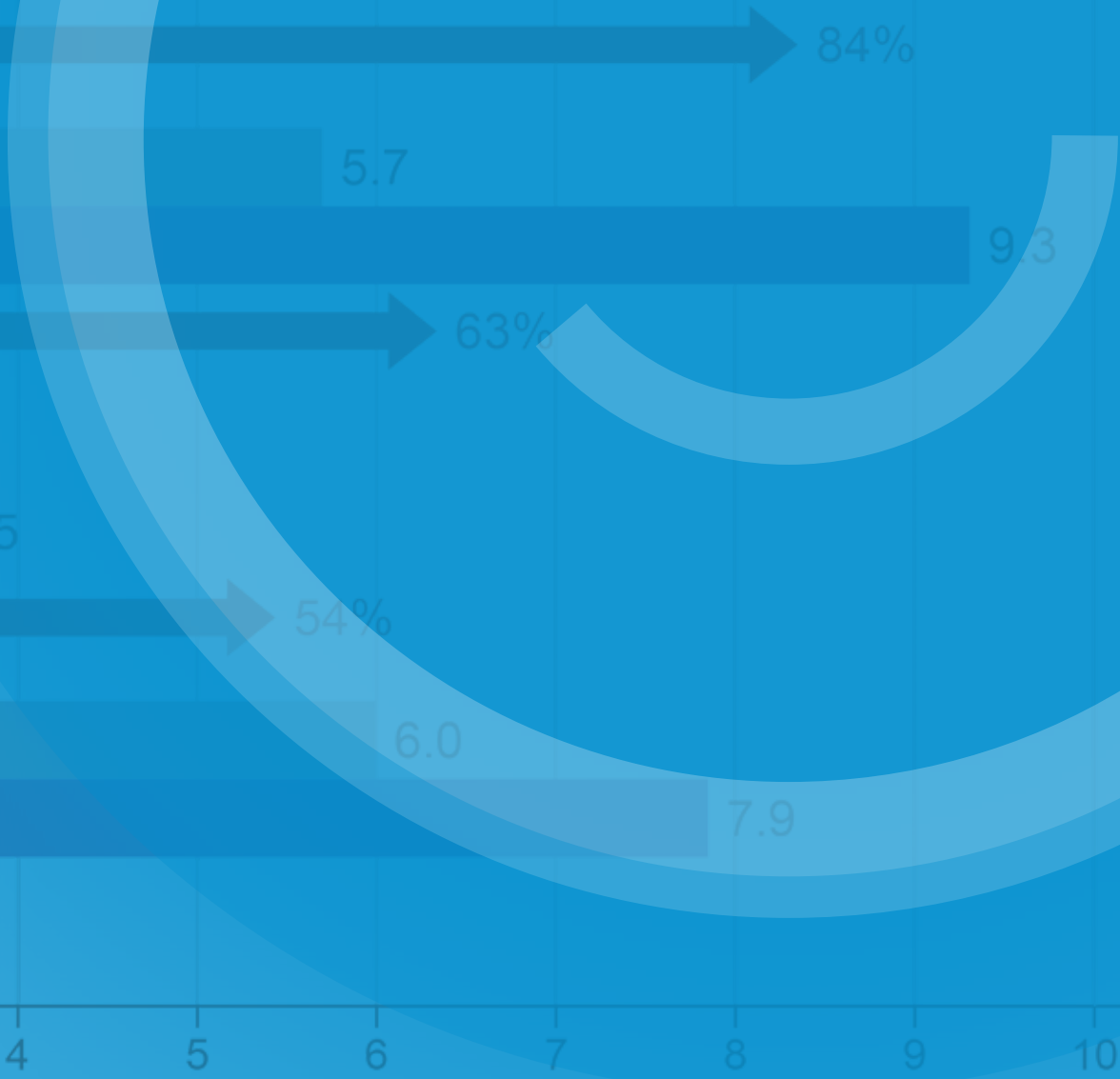

IARC: THE SECOND 50 YEARS

*Advances will be accelerated by “collective intelligence”.
I not only use all of the brains I have, but all I can borrow.*
– Woodrow Wilson

BIG IDEAS AND SMALL BEGINNINGS

IARC was born of a big idea: to redirect some of the vast sums of money that countries were investing in their military might, and to use these funds not to fight each other but to fight together against a common enemy: cancer. Cooperation, not conflict.

The protagonists set a challenge. Take a tiny fraction of the money spent on defence, just 0.5%, from the greatest military powers on both sides of the Second World War, and see what good could be achieved – leaving 99.5% of the resources intact and the balance of military might unaltered. If the impact of this symbolic shift could be visualized in terms of reduced human suffering, then perhaps questions would be asked about what other benefits might be reaped from further redistribution of resources. There was certainly more than a whiff of twin objectives in the air, given the involvement in nuclear disarmament of several of those promoting the project. Nevertheless, the starting point was the singular experience of human suffering by Yves Poggioli’s wife as a result of her cancer. Poggioli urged Emmanuel d’Astier de La Vigerie to use his influence to fight this disease, rather than using it only to fight for peace.

Of course, the dreamed-of financial model for IARC was never realized. The levy of 0.5% on defence budgets would have yielded an annual sum of US\$ 396 million, equivalent in 2014 to about US\$ 3 billion. For comparison, in 2014 the budget of the United States National Cancer Institute was US\$ 5.1 billion, that of the German Cancer Research Center was about US\$ 240 million, and IARC received US\$ 24 million. For Poggioli, the comparatively tiny 1965 budget for IARC, of less than US\$ 1 million, was a betrayal of the original vision. There is no record of whether d’Astier shared Poggioli’s disappointment, but the constant arguments of the French delegates for higher financial contributions indicate their undimmed enthusiasm for an organization big enough to make a difference. The tenacity with which Eugène Aujaleu applied himself up to and beyond the crucial resolution at the World Health Assembly in 1965 implies a pragmatic acceptance that the most important point was to see the Agency created. This was accompanied by a belief that money would follow as other countries shared the vision and joined forces as Participating States.

One can argue that the outcome in 1965 was not a bad one. IARC was a new creation. It had no staff, no building, and no scientific programme. It was required to write its own history. A new agency born into an inheritance of several hundred million dollars annually would have faced unprecedented expectation and perhaps aroused not a little envy from the cancer research community. Without doubt it would have

been a very different organization. One can conjecture that, unable to spend such a budget on its own research, the Agency would have taken on a much greater role as a funder of existing national research institutes and projects, rather than serving as a nucleus and catalyst for international cooperation.

As it was, IARC was allowed a childhood. The newly recruited scientists had time and freedom to decide where they could make the biggest difference. Notably, from the outset, the international cancer research community expressed enormous goodwill and respect towards this new agency. In turn, IARC started to establish its collaborations, working on projects that were local or regional in conduct but global in significance. Research projects were accompanied by training for national scientists – often their first opportunity to become familiar with epidemiological and other research methods. This engagement emphasized a partnership of equals, built on reciprocal benefits and trust. To conduct its work, IARC relied not on gigantic wealth but on a giant wave of cooperation.

It also became evident that the collaborative model, adopted both by design and of necessity, catalysed research far in excess of what could be achieved by IARC's budget alone. In effect, the in-kind contributions through the participation of scientists in joint research with IARC led to activities immeasurably greater than the investment made; this is still the case today, when this model is further amplified by grant funding won jointly by IARC and its partners. In addition, it was evident that a little money could go a long way in the developing countries. IARC Regional Centres, for example, were sustained by just US\$ 5000 per annum, and many an IARC-initiated project has sprung to life with smaller sums than this.

Thus, although the financial model of a 0.5% levy never materialized, its absence perhaps helped ensure that the second component of the big idea – a spirit of cooperation, a fight against a common enemy – was realized, and flourished. There was strength in partnership.

IARC's status as part of the World Health Organization (WHO) was no doubt part of the attraction for its new collaborators. Increasingly, however, this feature was bolstered by recognition that IARC was being shaped by some of the leading lights in cancer research in the late 1960s. Excellent scientists with an exciting vision started to draw together others of like mind from across the world, and

“
Equal credit and more goes to our colleagues in the countries because they have been working in the field. It is very gratifying to work in this large network and to know these people who, working under difficult circumstances, helped us.
– Rengaswamy Sankaranarayanan,
IARC scientist

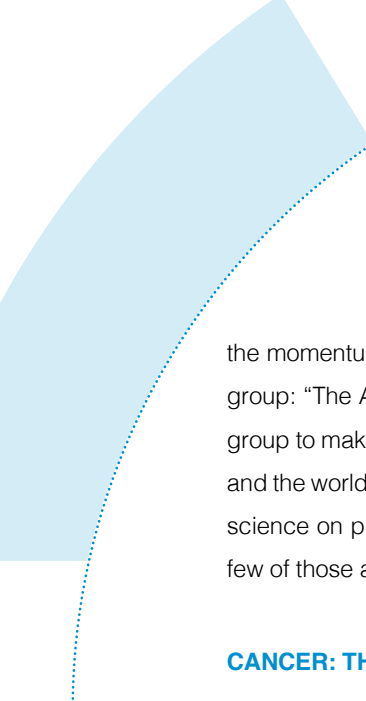

the momentum built. Nick Day, who joined IARC in late 1969, recalls the excitement among that pioneering group: “The Agency was only just beginning to get up steam, and I think we all felt that it was up to us as a group to make a success of this imaginative new venture. With the range of scientific disciplines represented and the worldwide contacts the Agency could call on, we felt we could make a difference by focusing modern science on problems of totally absorbing interest.” The short history contained in this book has illustrated a few of those areas where IARC has done just that over the first five decades of its existence.

CANCER: THE RIGHT PLACE AT THE RIGHT TIME

IARC has evolved markedly over 50 years to fulfil its mission to reduce the burden of cancer worldwide. Knowledge about the patterns of the disease, its causes, and its underlying biology, as well as advances in scientific methodology and technology and changes in the scale and make-up of the cancer research community have all shaped IARC’s progression. In contrast to these changes in activity, key principles continue to underpin the unique contribution of the Agency to international cancer research. Principled adaptability is the basis for a successful future.

The landscape of human disease is changing. IARC was born into a world where unique and extraordinary cancer patterns were found in developing countries, and much was learned about the causes of cancer from investigating these patterns. Nevertheless, at that time the major cause of premature death in these

Principled adaptability is the basis for a successful future.

countries was not cancer but infectious diseases, malnutrition, maternal and infant mortality, and other consequences of poverty. All too often the research findings from developing countries only found their practical application in terms of cancer prevention in developed countries; an example is the slow uptake of hepatitis B virus vaccine in the regions where infection with this virus is endemic. However, the beginning of the 21st

century is witness to a transition in developing countries, driven by population growth and ageing overlaid with evolving risk factor profiles, which are combining to cause rapid rises in the burden of noncommunicable diseases, including cancer.

Politicians are catching up with these trends in disease. Through the leadership of WHO and its partners, noncommunicable diseases are increasingly recognized by governments of low- and middle-income countries as a leading burden on health and the economy, presenting a barrier to sustainable human development. While this realization has not yet translated into a significant shift in health development assistance being directed to these chronic conditions, it surely will as the donors join the scientists and politicians in recognizing the transition.

These changes are significant for IARC: research results are less and less likely to be obtained in developing countries only to find application in developed countries. Increasingly, scientists and

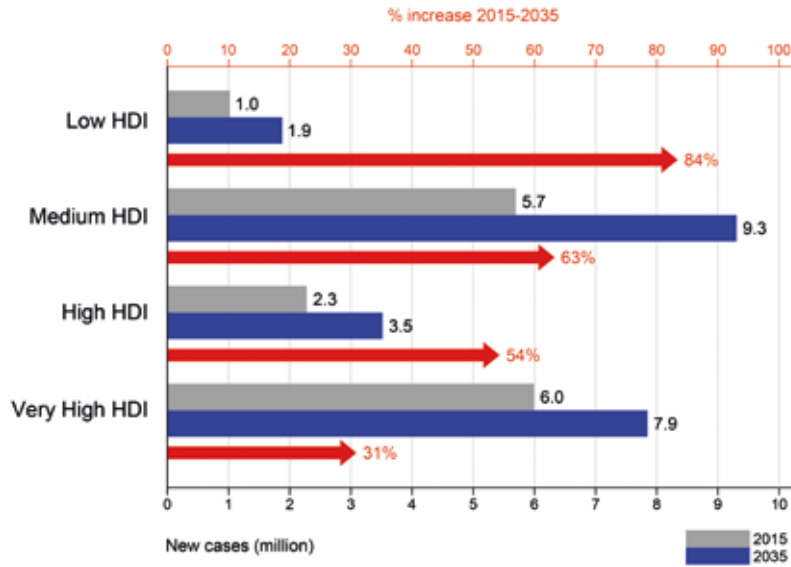

The estimated number of new cancer cases according to four levels of the Human Development Index (HDI): global projections for 2015 and 2035, assuming that rates remain constant, and the percentage increase over the 20-year period.

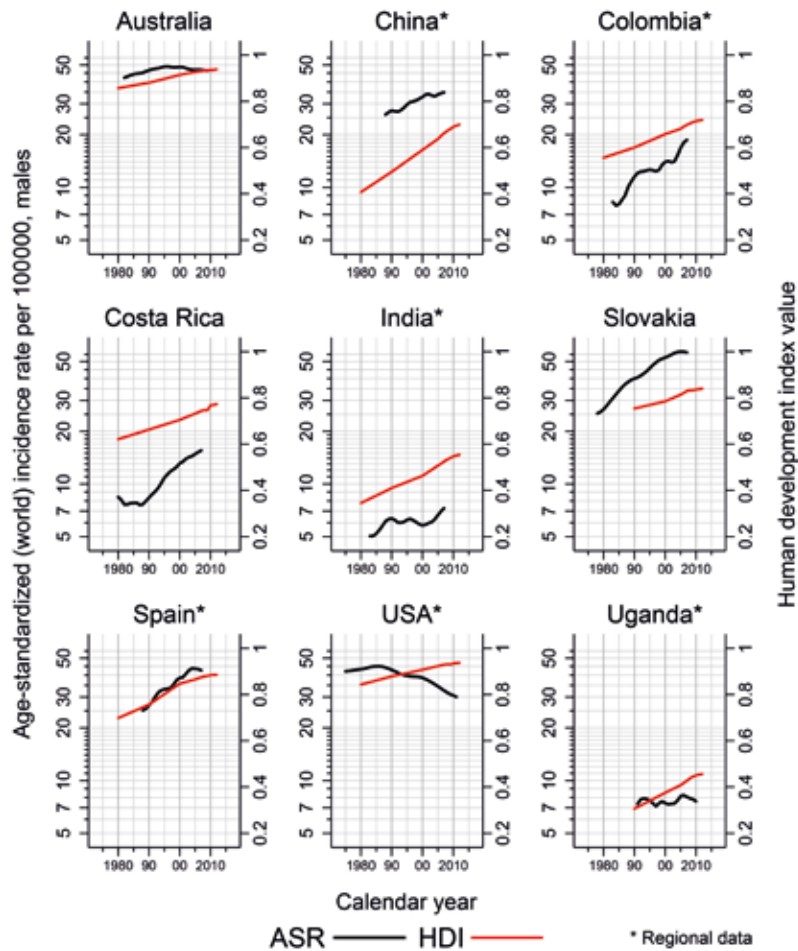

Trends in age-standardized (world) incidence rates (ASR) of colorectal cancer in men in 1978–2010 and in the Human Development Index (HDI) in 1980–2012 in selected countries.

health ministries in low- and middle-income countries will propose research directly relevant to cancer control in their own countries or regions. At the same time, scientific evidence for cancer control can be transferred from high-income countries to low- and middle-income countries, and vice versa, as countries face related challenges. In this context the collaborative model of the Agency is ideal, allowing IARC the freedom to conduct research wherever important questions can be best addressed and to make that information available to the widest audience possible.

Furthermore, among the noncommunicable diseases, cancer presents a particularly complex case in its diverse patterns, etiology, and underlying biology. It is fortunate, therefore, that there is a specialized cancer agency within WHO. IARC is ideally placed to assume a leadership role in shaping the cancer research agenda and providing the evidence base for cancer control in the decades ahead. However, such a response will require innovative approaches and new resources if the potential to make a difference is to be fully realized.

This future opportunity for IARC has arisen neither by chance nor by good luck. Rather, it is based on a relevant mission and vision, a strong research programme, and a 50-year track record of high-quality research conducted through partnership with colleagues throughout the world. Mutual trust and respect in time bear their fruit.



My best memory is of working with a group of very good scientists who were also very good people. For a young scientist to be able to work in that environment and gain from that experience was fantastic.

– Manolis Kogevinas, former IARC scientist

PREVENTION: THE RIGHT TOPIC AT THE RIGHT TIME

Cancer research is a broad endeavour, and IARC has to decide on priorities. The result is a concentration on “cancer research for cancer prevention”. Such research is essential but has been chronically under-resourced. For example, in 2014 Cancer Australia reported that in Australia, Canada, and the United Kingdom, only 2–3% of cancer research funding was assigned to prevention, with perhaps 10% to studies of etiology. This is despite the fact that the rapidly increasing burden of cancer and the spiralling costs of treatment and care mean that no country can treat its way out of the cancer problem.

The priority given in the high-income countries to investment in research into new therapies is driven by a complex mix of philosophy, emotion, advocacy, economics, and politics, far beyond the scope of this book. Over time, however, the contrast between the cost-effectiveness of treatment and that of prevention and early detection will be writ too large for policy-makers to ignore. At that point, a better balance across the

cancer research spectrum will be struck, at least for investment of public resources. The understandable desire to do better for patients will have to be complemented by efforts to avoid the development of cancer in the first place. The universal appreciation of this wisdom was represented in IARC's *World Cancer Report 2014* by a proverb from the Kalenjin tribe in Kenya: "It is better to put out the fire while it is still small." This provides an idiom for cancer prevention.

Prevention means different things to different people. For IARC, the emphasis is on describing the burden, understanding the causes, and evaluating interventions and their implementation. In turn, this cycle is completed by a visible reduction in burden, ultimately measured in cancer registries. This focus is best served by an interdisciplinary approach: from one end, bringing to bear the knowledge and technology derived from laboratory-based advances in understanding cancer biology, and from the other, the disciplines of behavioural and social sciences addressing important cancer risk factors operating all the way through from individuals to communities or whole societies. IARC will pursue its integration of the full spectrum of disciplines, drawing as it always has on the specialized expertise of national scientists through collaborative partnerships.

The past decade has seen a determined search for the causes of cancer in the molecular details of genetic variation between individuals in ever-bigger genome-wide association studies. One goal was to identify genetically susceptible subgroups of people and tailor preventive interventions, in an analogous fashion to the clinical treatments targeted to a genetically susceptible subgroup of tumours. However, cancer does not result from a simple individual attribute, genetic or otherwise. There is a need to come to a fresh understanding of health being affected by numerous complex individual characteristics and the wider societal context, requiring epidemiological studies that embrace the social determinants of cancer in a broad sense. An overarching factor will be the impact of climate change on health, something for which the scale and nature cannot be predicted at present. Each of these considerations will need to embrace the effects of exposures experienced at different stages of life, with the attendant clues as to critical windows for effective timing of interventions.

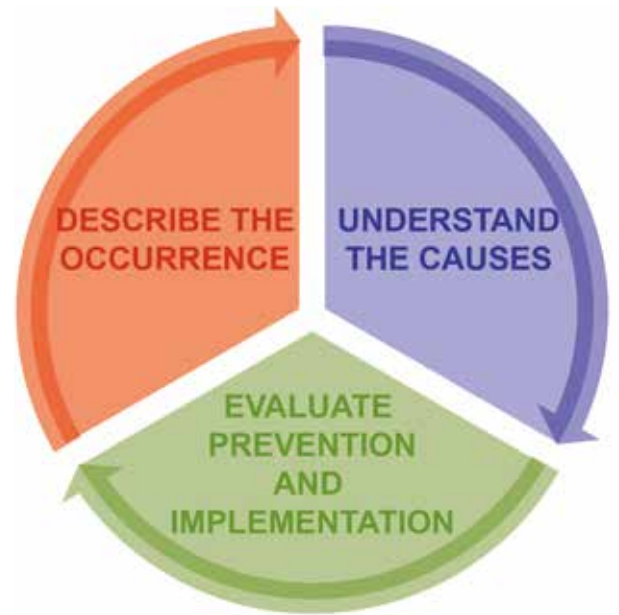

Cancer prevention is addressed by the Agency in three major areas of activity, as illustrated in this diagram.

Cancer prevention will one day become a fundamental question, and one with which IARC will be able to help France, which is lagging behind in that area.

– Thierry Philip, long-term IARC collaborator



IARC is conducting research with the government of Thailand to evaluate how best to implement a colorectal cancer screening programme and to enable effective scaling up of the programme across the country (see the chapter “Cancer screening and early diagnosis”). Shown here are some of the educational materials used to inform the population about the programme, as well as the tests used to detect blood in the faeces.

Notwithstanding the progress that has been made in cancer prevention to date, there remains a gap between the demonstrated efficacy of an intervention within the confines of an experimental trial and the effectiveness once that intervention is implemented at the health services level. There is a stark need to study the factors that either enable or block successful implementation. Such elements will likely differ between and within societies in relation to the widening inequities due to free-market economics. Implementation research is therefore an important but understudied area, and one that IARC is well placed to address, not only through its expertise but also through the opportunities that its international status brings to work with scientists and governments in evaluating and improving national programmes. Undoubtedly this research, with direct relevance to public health, will feature greatly in the future of the Agency.

Research will be further oriented to inform policy in moving to the next phase of the life of the Agency, but this eye towards application must never compromise scientific quality. Accurate data on the occurrence of cancer, on risk factors, and on preventive interventions all provide a portion of the evidence base for informed cancer control measures, but only if the data are reliable. For this to be the case, the research must make use of cutting-edge methods and knowledge. Therefore, IARC will continue not only to contribute original research findings but also to provide its authoritative stamp to collections of

“
The Monographs Programme is a reference: governments worldwide use these books and their assessments for setting policy in cancer control.
 – David Zaridze, former IARC scientist

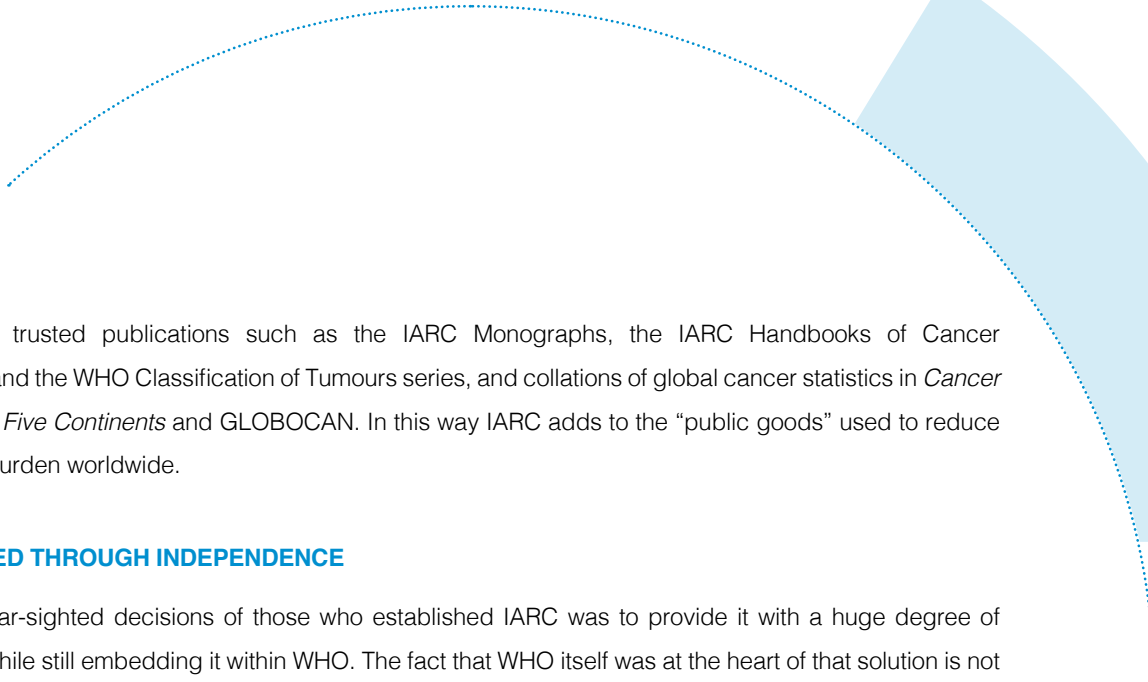

evidence in trusted publications such as the IARC Monographs, the IARC Handbooks of Cancer Prevention, and the WHO Classification of Tumours series, and collations of global cancer statistics in *Cancer Incidence in Five Continents* and GLOBOCAN. In this way IARC adds to the “public goods” used to reduce the cancer burden worldwide.

EMPOWERED THROUGH INDEPENDENCE

One of the far-sighted decisions of those who established IARC was to provide it with a huge degree of autonomy, while still embedding it within WHO. The fact that WHO itself was at the heart of that solution is not without significance. As John Higginson put it in 1971, IARC was “established within the framework of WHO, but empowered to develop its own research programmes.” It is a model that works well, akin to the healthy separation of powers, well established in political philosophy and practice.

The governance structure of IARC has allowed it to conduct its research free of political pressures. This independence also helps countries in the face of internal pressures, because the scientific conclusions from IARC are accepted as free from national interests. On occasion IARC’s voice will be heard where national scientific authorities may be censured to one degree or another. Second-hand tobacco smoke, diesel exhaust, mobile phones, shiftwork, nuclear radiation, and breast cancer screening are just some of the topics in recent years where the Agency has been able to consider the science free from outside influence. The IARC Governing Council deserves immense credit for maintaining this freedom and independence, which have underpinned the authority of the Agency’s work. Looking to the future, the constant vigilance on issues of conflict of interest must be maintained, just as much as the scientific vision and research programmes.

The quality, integrity, and independence of IARC are valued, but they increasingly stand out as exceptional. Therefore, these values should not be taken for granted. IARC works amid a maelstrom of lobbying, advocacy, and vested interests, often indirect and difficult to uncover. The push from many governments of developed countries during the past two decades to see academic researchers partner with the private sector has undoubtedly blurred the lines between the two domains. While bringing benefits in translating science into technology and economic growth, the reliance of researchers on private-sector funding erodes independence. This is problematic when independent evidence is needed. For example, if most research into nutrition and cancer were to be funded by the food industry, then maintaining freedom from real or perceived conflicts of interest would be fraught with difficulty.



“ IARC is quite different from the other entities in WHO, and it was refreshing to come to work here as the Agency is really oriented towards research.
– Keiji Saita, former Director of Administration and Finance at IARC



IARC will continue to guard its independence from vested interests, and must welcome outside scrutiny as a further check on adherence to its own values. A reputation is easily lost and is regained with difficulty. However, in keeping a distance from the private sector, IARC faces a challenge to fund its work, especially as countries tend to reduce in real terms their budget support to international organizations. Recent years have seen a split of about two thirds of IARC's overall expenditure from contributions by Participating States and one third from extrabudgetary sources, mainly from competitive grants and always in line with the approved IARC strategy. This balance would appear an important one to maintain. Donors and foundations offer an alternative to contributions from Participating States but have their own agendas, and the attendant risk of mission creep must be monitored. Therefore, the restriction on private-sector involvement goes hand in hand with the need to maintain an adequate regular budget from IARC Participating States. The original vision for IARC of a core regular budget supplemented by voluntary contributions from Participating States to support specific projects must be revisited as the economic recession of the past seven years lifts.

The possibility of linking the cancer agenda into the challenge of sustainable human development goals offers a creative way forward in relation to development assistance funding. The recognition of this link between cancer and human development also highlights again the link between cancer and the broader societal context in terms of the social determinants of the disease. In addition, as the cancer transition occurs, so too must a transition in the make-up of the governing body of the Agency, with more Participating States from the southern hemisphere stepping forward to add their insights, expertise, and financial contribution to this global cancer research effort.

ANOTHER WAY TO BE

IARC is a research agency, focused on cancer. It is founded on science. However, its modus operandi, in pursuing cooperation that cuts across human and infrastructure barriers, surely provides a beacon pointing to a different way of being in the 21st century, at a time when fractures within and across societies are all too evident. Under the one roof in Lyon, at any one time there are people of about 50 different nationalities and countless cultures working together in an atmosphere of friendship and towards common goals. This energy is fed by the constant stream of early career scientists arriving with their motivation and ambitions to make a positive contribution. The atmosphere is further magnified by the wider IARC "family" of collaborators from every part of the world. It is this spirit of cooperation that can carry the day even in the face of sensitive subjects. Certainly misunderstandings and disagreements arise in such settings, but the shared experience of meeting with like minds to address a humanitarian cause proves again and again to have the power to surmount differences.

An example of this theory in practice was evident at a meeting convened by IARC in 2013 that addressed the above-ground nuclear testing by the Soviet Union from 1949 to 1962 at Semipalatinsk in Kazakhstan and

FURTHER READING

IARC Annual Reports, from 1968 to 1985. Lyon, France: IARC.

IARC Biennial Reports, from 1986–1987 to 2012–2013. Lyon, France: IARC.

Sohier R, Sutherland AGB (1990). The Origin of the International Agency for Research on Cancer. IARC Technical Report No. 6. Lyon, France: IARC. Available from: <http://www.iarc.fr/en/publications/pdfs-online/treport-pub/treport-pub6/index.php>.

Vignes CH (1967). Le Centre international de Recherche sur le Cancer. *Annuaire français de droit international*. 13:531–544.

WHO (1968). The Second Ten Years of the World Health Organization, 1958–1967. Geneva: WHO. Available from: http://www.who.int/global_health_histories/who_history/en/.

WHO (2008). The Third Ten Years of the World Health Organization, 1968–1977. Geneva: WHO. Available from: http://www.who.int/global_health_histories/who_history/en/.

SOURCES

IMAGES

- page viii** (top, bottom) IARC photo library/R. Dray.
- pages 10–11** © 141118LPL890/PHOTOPQR/LE PROGRES.
- page 13** Courtesy of the Musée de l'Ordre de la Libération.
- page 16** With kind permission from Le Monde, © Le Monde, 8 November 1963.
- page 17** Courtesy of the Latarjet family.
- page 20** © INSERM/Michel Depardieu.
- page 23** Courtesy of the Union for International Cancer Control (UICC).
- page 24** IARC photo library.
- page 26** IARC archives.
- page 29** IARC archives.
- page 30** © 141118LPL890/PHOTOPQR/LE PROGRES.
- page 33** IARC archives.
- page 34** IARC photo library.
- page 35** (top) WHO/Tibor Farkas; (bottom) WHO/Jean Mohr.
- page 36** IARC archives.
- page 37** IARC photo library.
- page 38** Courtesy of the Latarjet family.
- page 39** (top) IARC photo library/R. Dray; (bottom) IARC photo library.
- page 41** WHO/Paul Almasy.
- page 42** (top, bottom) IARC photo library.
- pages 44–45** FIPOI © Luca Fascini.
- page 47** (left, right) FIPOI © Luca Fascini.
- page 48** (top) Adapted from McKeown T (1976). *The Role of Medicine: Dream, Mirage or Nemesis?* London, United Kingdom: Nuffield Provincial Hospitals Trust; <http://www.nuffieldtrust.org.uk/publications/role-medicine-dream-mirage-or-nemesis> (accessed 5 October 2014), © The Nuffield Trust. Reproduced with permission; (bottom) Adapted from Holland WW, Olsen J, Florey CdV, editors (2007). *The Development of Modern Epidemiology: Personal Reports from Those Who Were There*. Oxford, United Kingdom: Oxford University Press, Figure 4.1, by permission of Oxford University Press.
- page 50** IARC photo library/R. Dray.
- page 53** IARC photo library.
- page 54** © Michael Crabtree/Troiika.
- page 57** Courtesy of Munksgaard Publishing.
- page 58** IARC photo library/R. Dray.
- page 59** (left) Courtesy of the Union for International Cancer Control (UICC); (right) Courtesy of the Waterhouse family.
- page 65** Reprinted from Murphy M, Bobak M, Nicholson A, Rose R, Marmot M (2006). The widening gap in mortality by educational level in the Russian Federation, 1980–2001. *Am J Public Health*. 96(7):1293–9. <http://dx.doi.org/10.2105/AJPH.2004.056929> PMID:16735629, with permission from The Sheridan Press.
- page 66** Reprinted from Milanovic B (2012). *Global Income Inequality by the Numbers: in History and Now – An Overview*. © World Bank; <http://elibrary.worldbank.org/doi/pdf/10.1596/1813-9450-6259>. Licence: Creative Commons Attribution CC BY 3.0.
- page 67** Reprinted from Ng M, Fleming T, Robinson M, Thomson B, Graetz N, Margono C, et al. (2014). Global, regional, and national prevalence of overweight and obesity in children and adults during 1980–2013: a systematic analysis for the Global Burden of Disease Study 2013. *Lancet*. 384(9945):766–81. [http://dx.doi.org/10.1016/S0140-6736\(14\)60460-8](http://dx.doi.org/10.1016/S0140-6736(14)60460-8) PMID:24880830, © 2014, with permission from Elsevier.
- pages 70–71** IARC photo library.
- page 72** IARC photo library.
- page 74** IARC Education and Training Group.
- page 75** Courtesy of Mónica Sierra.
- page 76** (left) IARC photo library; (centre) Courtesy of Jack Siemiatycki; (right) IARC photo library.
- page 77** © Lyon Reportage.
- page 78** Courtesy of Cold Spring Harbor Laboratory Archives.
- page 79** From IARC Laboratory Notebook 534 of Norman Moullan, page 72, 16/11/2001 (unpublished data).
- page 80** IARC photo library.
- page 81** Courtesy of Monique Davis.
- page 82** IARC Education and Training Group.
- page 83** (top, bottom) IARC photo library.
- page 84** IARC Education and Training Group.
- page 85** IARC photo library.
- page 86** IARC photo library.
- page 87** (top) © Hiroko Ohgaki; (bottom, upper left) © Yoichi Nakazato; (bottom, upper right) © Paul Kleihues; (bottom, lower left) © Guido Reifenberger; (bottom, lower right) © Arie Perry.
- pages 88–89** Reprinted from Armstrong B, Doll R (1975). Environmental factors and cancer incidence and mortality in different countries, with special reference to dietary practices. *Int J Cancer*. 15(4):617–31. <http://dx.doi.org/10.1002/ijc.2910150411> PMID:1140864.
- page 90** © Lyon Reportage.
- page 91** (left, right) IARC photo library.
- page 92** IARC photo library.
- page 93** IARC photo library.
- page 94** Adapted from IARC (1971). *IARC Annual Report 1970*. Lyon, France: IARC.
- page 97** Reprinted from IARC (1976). *IARC Annual Report 1975*. Lyon, France: IARC.
- page 99** IARC photo library/R. Dray.

- page 101** Reprinted from Armstrong B, Doll R (1975). Environmental factors and cancer incidence and mortality in different countries, with special reference to dietary practices. *Int J Cancer*. 15(4):617–31. <http://dx.doi.org/10.1002/ijc.2910150411> PMID:1140864.
- pages 104–105** WHO/Jean Mohr.
- page 106** Reprinted from Clemmesen J (1965). *Statistical Studies in the Aetiology of Malignant Neoplasms, Vol. 1, Review and Results*. Copenhagen, Denmark: Munksgaard Publishers.; Figure 42, page 250. Adapted from Rigoni-Stern D (1844). *Intorno al trattato critico sulla febbre del dott. G. B. Mugna ed all'arterite: Osservazioni*. Verona, Italy: Tipografia di Giuseppe Antonelli.
- page 107** IARC photo library.
- page 108** IARC archives.
- page 110** WHO/Jean Mohr.
- page 112** Reprinted from Fritz A, Percy C, Jack A, Shanmugaratnam K, Sobin L, Parkin DM, et al., editors (2013). *International Classification of Diseases for Oncology (ICD-O), 3rd edition, 1st revision*. Geneva: World Health Organization.
- page 113** IARC photo library.
- page 114** IARC photo library.
- page 115** IARC Section of Cancer Surveillance.
- page 116** Data compiled from the United Nations Development Programme.
- page 117** IARC Section of Cancer Surveillance.
- page 119** IARC photo library.
- pages 120–121** Reprinted from Badwe RA, Dikshit R, Laversanne M, Bray F (2014). Cancer incidence trends in India. *Jpn J Clin Oncol*. 44(5):401–7. <http://dx.doi.org/10.1093/jjco/hyu040> PMID:24755545, by permission of Oxford University Press.
- page 123** © The Nuffield Trust. Reproduced with permission. Taken from Doll R (1967). *Prevention of Cancer: Pointers from Epidemiology*. London: Nuffield Provincial Hospitals Trust.
- page 124** (left, right) IARC photo library.
- page 125** (top, bottom) IARC photo library.
- page 126** From Forman D, Bray F, Brewster DH, Gombe Mbalawa C, Kohler B, Piñeros M, et al., editors (2013). *Cancer Incidence in Five Continents, Vol. X (electronic version)*. Lyon, France: IARC. Available at <http://ci5.iarc.fr>.
- page 127** Reprinted from Badwe RA, Dikshit R, Laversanne M, Bray F (2014). Cancer incidence trends in India. *Jpn J Clin Oncol*. 44(5):401–7. <http://dx.doi.org/10.1093/jjco/hyu040> PMID:24755545, by permission of Oxford University Press.
- page 128** Reprinted from Steinitz R, Parkin DM, Young JL, Bieber CA, Katz L (1990). *Cancer Incidence in Jewish Migrants to Israel, 1961–1981*. IARC Scientific Publication No. 98. Lyon, France: IARC.
- page 129** Reprinted from Steinitz R, Parkin DM, Young JL, Bieber CA, Katz L (1990). *Cancer Incidence in Jewish Migrants to Israel, 1961–1981*. IARC Scientific Publication No. 98. Lyon, France: IARC.
- page 130** Reproduced from Thun M, Peto R, Boreham J, Lopez AD (2012). Stages of the cigarette epidemic on entering its second century. *Tob Control*. 21(2):96–101. <http://dx.doi.org/10.1136/tobaccocontrol-2011-050294> PMID:22345230, with permission from BMJ Publishing Group Ltd.
- page 131** Adapted from Montanaro F, Bray F, Gennaro V, Merler E, Tyczynski JE, Parkin DM, et al.; ENCR Working Group (2003). Pleural mesothelioma incidence in Europe: evidence of some deceleration in the increasing trends. *Cancer Causes Control*. 14(8):791–803. <http://dx.doi.org/10.1023/A:1026300619747> PMID:14674744. Springer/Kluwer Academic Publishers; Figure 2, page 795, with kind permission from Springer Science+Business Media.
- page 132** (left, centre, right) IARC photo library.
- page 133** (top, bottom) Data compiled from the Global Health Observatory Data Repository.
- page 134** From Ferlay J, Soerjomataram I, Ervik M, Dikshit R, Eser S, Mathers C, et al. (2013). *GLOBOCAN 2012 v1.0, Cancer Incidence and Mortality Worldwide: IARC CancerBase No. 11* [Internet]. Lyon, France: IARC. Available at <http://globocan.iarc.fr>.
- page 136** Reprinted from Arnold M, Pandeya N, Byrnes G, Renehan AG, Stevens GA, Ezzati M, et al. (2015). Global burden of cancer attributable to high body-mass index in 2012: a population-based study. *Lancet Oncol*. 16(1):36–46. [http://dx.doi.org/10.1016/S1470-2045\(14\)71123-4](http://dx.doi.org/10.1016/S1470-2045(14)71123-4) PMID:25467404, © 2015, with permission from Elsevier.
- page 137** IARC photo library.
- pages 138–139** IARC photo library/R. Dray.
- page 141** CCDC/Barbara Jenkins, NIOSH, Dick Robbins.
- page 143** IARC photo library.
- page 144** IARC photo library.
- page 147** IARC photo library/R. Dray.
- page 148** IARC photo library.
- page 149** Courtesy of Gerald N. Wogan.
- page 150** IARC photo library.
- page 152** IARC photo library.
- page 153** Reprinted from Saracci R, Simonato L, Baris Y, Artvinli M, Skidmore J (1982). The age-mortality curve of endemic pleural mesothelioma in Karain, Central Turkey. *Br J Cancer*. 45(1):147–9. <http://dx.doi.org/10.1038/bjc.1982.19> PMID:7059459, by permission from Macmillan Publishers Ltd on behalf of Cancer Research UK, © 1982.
- page 156** Courtesy of the United States Public Health Service, Office of the Surgeon General.
- page 157** Adapted from Boffetta P, Agudo A, Ahrens W, Benhamou E, Benhamou S, Darby SC, et al. (1998). Multicenter case-control study of exposure to environmental tobacco smoke and lung cancer in Europe. *J Natl Cancer Inst*. 90(19):1440–50. <http://dx.doi.org/10.1093/jnci/90.19.1440> PMID:9776409, with permission from Oxford University Press.
- page 158** Reproduced with permission from BMJ Publishing Group Ltd. Doll R, Peto R, Boreham J, Sutherland I (2004). Mortality in relation to smoking: 50 years' observations on male British doctors. *BMJ*, 328:1519–1527. <http://dx.doi.org/10.1136/bmj.38142.554479.AE> PMID:15213107, © 2004.
- page 159** IARC photo library.
- pages 160–161** IARC photo library.

- page 162** Reprinted from Tannenbaum A, Silverstone H (1953). Nutrition in relation to cancer. *Adv Cancer Res.* 1:451–501. [http://dx.doi.org/10.1016/S0065-230X\(08\)60009-3](http://dx.doi.org/10.1016/S0065-230X(08)60009-3) PMID:13057710, © 1953, with permission from Elsevier.
- page 163** (top) Reprinted from IARC (1971). IARC Annual Report 1970. Lyon, France: IARC; (bottom) IARC photo library.
- page 165** Adapted from Wikimedia Commons: Mohammadreza Kamali © 2011.
- page 166** Reprinted from Riboli E, Elmståhl S, Saracci R, Gullberg B, Lindgärde F (1997). The Malmö Food Study: validity of two dietary assessment methods for measuring nutrient intake. *Int J Epidemiol.* 26(90001) Suppl 1:S161–73. http://dx.doi.org/10.1093/ije/26.suppl_1.S161 PMID:9126544.
- page 167** Courtesy of Imperial College London/Thomas Angus.
- page 168** Adapted from Bingham S, Riboli E (2004). Diet and cancer—the European Prospective Investigation into Cancer and Nutrition. *Nat Rev Cancer.* 4(3):206–15. <http://dx.doi.org/10.1038/nrc1298> PMID:14993902, by permission from Macmillan Publishers Ltd, © 2004.
- page 169** IARC photo library/R. Dray.
- page 170** Reprinted from Crispim SP, Nicolas G, Casagrande C, Knaze V, Illner AK, Huybrechts I, et al. (2014). Quality assurance of the international computerised 24 h dietary recall method (EPIC-Soft). *Br J Nutr.* 111(3):506–15. <http://dx.doi.org/10.1017/S0007114513002766> PMID:24001201, reproduced with permission from Cambridge University Press.
- page 171** Courtesy of Norfolk and Norwich University Hospital.
- page 172** (left, centre, right) IARC photo library.
- page 174** Adapted from Slimani N, Fahey M, Welch AA, Wirfält E, Stripp C, Bergström E, et al. (2002). Diversity of dietary patterns observed in the European Prospective Investigation into Cancer and Nutrition (EPIC) project. *Public Health Nutr.* 5(6B) 6B:1311–28. <http://dx.doi.org/10.1079/PHN2002407> PMID:12639235.
- page 176** Reprinted from Norat T, Bingham S, Ferrari P, Slimani N, Jenab M, Mazuir M, et al. (2005). Meat, fish, and colorectal cancer risk: the European Prospective Investigation into Cancer and Nutrition. *J Natl Cancer Inst.* 97(12):906–16. <http://dx.doi.org/10.1093/jnci/dji164> PMID:15956652.
- page 177** Adapted from Pischon T, Boeing H, Hoffmann K, Bergmann M, Schulze MB, Overvad K, et al. (2008). General and abdominal adiposity and risk of death in Europe. *N Engl J Med.* 359(20):2105–20. <http://dx.doi.org/10.1056/NEJMoa0801891> PMID:19005195.
- page 179** IARC/Nadia Slimani. Compiled from Pisa PT, Landais E, Margetts B, Vorster HH, Friedenreich CM, Huybrechts I, et al. (2014). Inventory on the dietary assessment tools available and needed in Africa: a prerequisite for setting up a common methodological research infrastructure for nutritional surveillance, research and prevention of diet-related non-communicable diseases. *Crit Rev Food Sci Nutr.* <http://dx.doi.org/10.1080/10408398.2014.981630>.
- pages 180–181** Reprinted from Rothman N, Hainaut P, Schulte P, Smith M, Boffetta P, Perera F, editors (2011). *Molecular Epidemiology: Principles and Practices*. IARC Scientific Publication No. 163. Lyon, France: IARC.
- page 183** IARC Biobank.
- page 184** Reprinted from Groopman JD, Hall AJ, Whittle H, Hudson GJ, Wogan GN, Montesano R, et al. (1992). Molecular dosimetry of aflatoxin-N7-guanine in human urine obtained in The Gambia, West Africa. *Cancer Epidemiol Biomarkers Prev.* 1(3):221–7. PMID:1339082, © 1992 American Association for Cancer Research.
- page 185** Reprinted from Wild CP, Scalbert A, Herceg Z (2013). Measuring the exposome: a powerful basis for evaluating environmental exposures and cancer risk. *Environ Mol Mutagen.* 54(7):480–99. <http://dx.doi.org/10.1002/em.21777> PMID:23681765.
- page 186** IARC photo library.
- page 187** (left, centre, right) IARC photo library.
- page 188** (top) Adapted from Shi H, Le Calvez F, Olivier M, Hainaut P (2005). Patterns of TP53 mutations in human cancer: interplay between mutagenesis, DNA repair and selection. In: Hainaut P, Wiman KG, editors. *25 Years of p53 Research*. Dordrecht, The Netherlands: Springer, pp. 293–319, Figure 1, with kind permission from Springer Science+Business Media; (bottom) WHO/Jean Mohr.
- page 189** Reprinted from Scelo G, Riazalhosseini Y, Greger L, Letourneau L, González-Porta M, Wozniak MB, et al. (2014). Variation in genomic landscape of clear cell renal cell carcinoma across Europe. *Nat Commun.* 5:5135. PMID:25351205, by permission from Macmillan Publishers Ltd, © 2014.
- page 190** IARC photo library.
- page 191** (top) Adapted from © iStockphoto/VLADGRIN 2014; (bottom) Adapted from Sobol H, Narod SA, Nakamura Y, Boneu A, Calmettes C, Chadenas D, et al. (1989). Screening for multiple endocrine neoplasia type 2a with DNA-polymorphism analysis. *N Engl J Med.* 321(15):996–1001. <http://dx.doi.org/10.1056/NEJM198910123211502> PMID:2571086, © 1989 Massachusetts Medical Society. Reprinted with permission from Massachusetts Medical Society.
- page 192** IARC photo library.
- page 194** Reprinted from Rothman N, Hainaut P, Schulte P, Smith M, Boffetta P, Perera F, editors (2011). *Molecular Epidemiology: Principles and Practices*. IARC Scientific Publication No. 163. Lyon, France: IARC.
- page 195** Courtesy of the American Association for Cancer Research.
- page 196** (top) Reprinted from IARC (1999). IARC Biennial Report 1998–1999. Lyon, France: IARC; (bottom) IARC photo library.
- page 198** Adapted from Ohgaki H, Dessen P, Jourde B, Horstmann S, Nishikawa T, Di Patre PL, et al. (2004). Genetic pathways to glioblastoma: a population-based study. *Cancer Res.* 64(19):6892–9. <http://dx.doi.org/10.1158/0008-5472.CAN-04-1337> PMID:15466178, © 2004 American Association for Cancer Research.
- pages 200–201** © Elaine S. Jaffe.
- page 203** (top) IARC photo library; (bottom) © Elaine S. Jaffe.
- page 204** (top) IARC photo library; (bottom) Adapted from Geser A, de Thé G, Lenoir G, Day NE, Williams EH (1982). Final case reporting from the Ugandan prospective study of the relationship between EBV and Burkitt's lymphoma. *Int J Cancer.* 29(4):397–400. <http://dx.doi.org/10.1002/ijc.2910290406> PMID:6282763, with permission from Wiley.

- page 205** Adapted from IARC (1972). IARC Annual Report 1971. Lyon, France: IARC.
- page 206** From Ferlay J, Soerjomataram I, Ervik M, Dikshit R, Eser S, Mathers C, et al. (2013). GLOBOCAN 2012 v1.0, Cancer Incidence and Mortality Worldwide: IARC CancerBase No. 11 [Internet]. Lyon, France: IARC. Available at <http://globocan.iarc.fr>.
- page 207** Reprinted from Muñoz N, Bosch FX, de Sanjosé S, Tafur L, Izarzugaza I, Gili M, et al. (1992). The causal link between human papillomavirus and invasive cervical cancer: a population-based case-control study in Colombia and Spain. *Int J Cancer*. 52(5):743–9. <http://dx.doi.org/10.1002/ijc.2910520513> PMID:1330933, © 2006. Available from: <http://onlinelibrary.wiley.com/doi/10.1002/ijc.2910520513/abstract>.
- page 208** IARC photo library.
- page 209** Courtesy of Nubia Muñoz.
- page 210** Reprinted from Robboy SJ, Mutter GL, Prat J, Bentley RC, Russell P, Anderson MC, editors (2009). *Robboy's Pathology of the Female Reproductive Tract*, 2nd edition, p. 191. © 2009, with permission from Churchill Livingstone/Elsevier.
- page 211** Reprinted from Crosbie EJ, Einstein MH, Franceschi S, Kitchener HC (2013). Human papillomavirus and cervical cancer. *Lancet*. 382(9895):889–99. [http://dx.doi.org/10.1016/S0140-6736\(13\)60022-7](http://dx.doi.org/10.1016/S0140-6736(13)60022-7) PMID:23618600, © 2013, with permission from Elsevier.
- page 212** Adapted from an unpublished figure (courtesy of Robert D. Burk and Zigui Chen).
- page 213** Reprinted from de Martel C, Ferlay J, Franceschi S, Vignat J, Bray F, Forman D, et al. (2012). Global burden of cancers attributable to infections in 2008: a review and synthetic analysis. *Lancet Oncol*. 13(6):607–15. [http://dx.doi.org/10.1016/S1470-2045\(12\)70137-7](http://dx.doi.org/10.1016/S1470-2045(12)70137-7) PMID:22575588, © 2012, with permission from Elsevier.
- page 216** (top) Reprinted from Ott JJ, Stevens GA, Groeger J, Wiersma ST (2012). Global epidemiology of hepatitis B virus infection: new estimates of age-specific HBsAg seroprevalence and endemicity. *Vaccine*. 30(12):2212–9. <http://dx.doi.org/10.1016/j.vaccine.2011.12.116> PMID:22273662, © 2012, with permission from Elsevier; (bottom) Reprinted from Shimakawa Y, Lemoine M, Mendy M, Njai HF, D'Alessandro U, Hall A, et al. (2014). Population-based interventions to reduce the public health burden related with hepatitis B virus infection in The Gambia, West Africa. *Trop Med Health*. 42(2) Suppl:59–64. <http://dx.doi.org/10.2149/tmh.2014-S08> PMID:25425952.
- page 217** Adapted from Shimakawa Y, Lemoine M, Mendy M, Njai HF, D'Alessandro U, Hall A, et al. (2014). Population-based interventions to reduce the public health burden related with hepatitis B virus infection in The Gambia, West Africa. *Trop Med Health*. 42(2) Suppl:59–64. <http://dx.doi.org/10.2149/tmh.2014-S08> PMID:25425952.
- page 220** Courtesy of Andrew Hall/London School of Hygiene & Tropical Medicine.
- pages 222–223** Adapted from de Koning HJ (2009). *The mysterious mass(es)*. [Inaugural address, Professor of Screening Evaluation.] Rotterdam, The Netherlands: Erasmus MC.
- page 225** Reprinted from Läärä E, Day NE, Hakama M (1987). Trends in mortality from cervical cancer in the Nordic countries: association with organised screening programmes. *Lancet*. 329(8544):1247–9. [http://dx.doi.org/10.1016/S0140-6736\(87\)92695-X](http://dx.doi.org/10.1016/S0140-6736(87)92695-X) PMID:2884378, © 1987, with permission from Elsevier.
- page 226** Adapted from de Koning HJ (2009). *The mysterious mass(es)*. [Inaugural address, Professor of Screening Evaluation.] Rotterdam, The Netherlands: Erasmus MC.
- page 227** IARC photo library.
- page 228** IARC photo library.
- page 229** From Sankaranarayanan R, Nene BM, Shastri SS, Jayant K, Muwonge R, Budukh AM, et al. (2009). HPV screening for cervical cancer in rural India. *N Engl J Med*. 360(14):1385–94. <http://dx.doi.org/10.1056/NEJMoa0808516> PMID:19339719, © 2009, Massachusetts Medical Society. Reprinted with permission from Massachusetts Medical Society.
- page 230** IARC Screening Group.
- page 231** WHO/SEARO/Anubhav Das.
- page 232** Rengaswamy Sankaranarayanan/IARC.
- page 233** IARC photo library.
- page 234** WHO/PAHO/Carlos Gaggero.
- page 235** IARC photo library.
- pages 236–237** Freddie Bray/IARC.
- page 241** (top) Freddie Bray/IARC; (bottom) Data compiled from Ferlay J, Soerjomataram I, Ervik M, Dikshit R, Eser S, Mathers C, et al. (2013). GLOBOCAN 2012 v1.0, Cancer Incidence and Mortality Worldwide: IARC CancerBase No. 11 [Internet]. Lyon, France: IARC. Available at <http://globocan.iarc.fr>, and the United Nations Development Programme.
- page 243** Christopher P. Wild/IARC.
- page 244** Krittika Pitaksaringkarn/IARC.
- page 247** IARC photo library/R. Dray.
- page 258** IARC photo library/R. Dray.
- page 259** (top) IARC photo library; (bottom) IARC photo library/R. Dray.

TABLES

page 56 Compiled from Doll R (1967). *Prevention of Cancer: Pointers from Epidemiology*. London: Nuffield Provincial Hospitals Trust. [In addition, Doll mentions as doubtful at the time the evidence of carcinogenicity for some other factors, including urban air pollution.]

page 61 Data for 1947–1951: Compiled from Shimkin MB, Griswold MH, Cutler SJ (1984). *Classics in oncology. Survival in untreated and treated cancer*. *CA Cancer J Clin*. 34(5):282–94. <http://dx.doi.org/10.3322/canjclin.34.5.282> PMID:6432240 (data of the Connecticut Tumor Registry). Data for 1975–1977 and 2003–2009: Compiled from American Cancer Society (2014). *Cancer Facts & Figures 2014*. Atlanta, Georgia: American Cancer Society (from nine registration areas within the USA; data for all ethnicities and both sexes combined).

page 62 Adapted from United Nations, Department of Economic and Social Affairs, Population Division (2011). *World Population 2010 (Wall Chart)*. ST/ESA/SER.A/307.

page 64 Reproduced, with the permission of the publisher, from WHO (2008). *Closing the Gap in a Generation: Health Equity Through Action on the Social Determinants of Health: Final Report of The Commission on Social Determinants of Health*. Geneva: World Health Organization (Table 2.1, Page 32. http://www.who.int/social_determinants/final_report/csdh_finalreport_2008.pdf, accessed 9 September 2014).

page 69 Compiled from Baade PD, Youlten DR, Valery PC, Hassall T, Ward L, Green AC, et al. (2010). Population-based survival estimates for childhood cancer in Australia during the period 1997–2006. *Br J Cancer*. 103(11):1663–70. <http://dx.doi.org/10.1038/sj.bjc.6605985> PMID:21063404; Bao PP, Zheng Y, Wu CX, Peng P, Gong YM, Huang ZZ, et al. (2012). Population-based survival for childhood cancer patients diagnosed during 2002–2005 in Shanghai, China. *Pediatr Blood Cancer*. 59(4):657–61. <http://dx.doi.org/10.1002/pbc.24043> PMID:22302759; Swaminathan R, Rama R, Shanta V (2008). Childhood cancers in Chennai, India, 1990–2001: incidence and survival. *Int J Cancer*. 122(11):2607–11. <http://dx.doi.org/10.1002/ijc.23428> PMID:18324630; Wiangnon S, Veerakul G, Nuchprayoon I, Seksarn P, Hongeng S, Krutvecho T, et al. (2011). Childhood cancer incidence and survival 2003–2005, Thailand: study from the Thai Pediatric Oncology Group. *Asian Pac J Cancer Prev*. 12(9):2215–20. PMID:22296359.

page 135 Compiled from Forman D, Bray F, Brewster DH, Gombe Mbalawa C, Kohler B, Piñeros M, et al., editors (2013). *Cancer Incidence in Five Continents, Vol. X (electronic version)*. Lyon, France: IARC. Available at <http://ci5.iarc.fr>.

page 150 Reprinted from IARC (1971). *IARC Annual Report 1970*. Lyon, France: IARC.

TEXT

Unless otherwise indicated, all text quotations included in this book are extracted from interviews conducted by IARC for this book.

page 12 (Tomatis quotation) From Sohier R, Sutherland AGB (1990). The Origin of the International Agency for Research on Cancer. IARC Technical Report No. 6. Lyon, France: IARC. Available from: <http://www.iarc.fr/en/publications/pdfs-online/treport-pub/treport-pub6/index.php>.

pages 13–14 (“Emmanuel d’Astier de La Vigerie – liberation from the burden of cancer”) From Crémieux F (1966). Entretiens avec Emmanuel d’Astier. Paris: Éditions Pierre Belfond; and d’Astier de La Vigerie G (2010). Emmanuel d’Astier de La Vigerie: Combattant de la Résistance et de la Liberté, 1940–1944. Chaintreaux: Éditions France-Empire Monde.

page 14 (line 4) From Crémieux F (1996). Entretiens avec Emmanuel d’Astier. Paris: Éditions Pierre Belfond; (line 28) From Emmanuel d’Astier (1963). Une Requête. Le Monde, 21 November 1963.

page 15 (line 11) From Emmanuel d’Astier (1963). Une Requête. Le Monde, 21 November 1963; (Co-signatories to the open letter) From Sohier R, Sutherland AGB (1990). The Origin of the International Agency for Research on Cancer. IARC Technical Report No. 6. Lyon, France: IARC. Available from: <http://www.iarc.fr/en/publications/pdfs-online/treport-pub/treport-pub6/index.php>.

page 18 (“Reply from General de Gaulle”) From Sohier R, Sutherland AGB (1990). The Origin of the International Agency for Research on Cancer. IARC Technical Report No. 6. Lyon, France: IARC. Available from: <http://www.iarc.fr/en/publications/pdfs-online/treport-pub/treport-pub6/index.php>.

page 19 (line 13) From WHO interview with AGB Sutherland, IARC archives.

page 21 (lines 23 and 33) From WHO (2008). The Third Ten Years of the World Health Organization, 1968–1977. Geneva: WHO. Available from: http://www.who.int/global_health_histories/who_history/en/.

page 23 (lines 31–34) From Alexander Haddow’s opening speech at the UICC conference in Stockholm, September 1964, IARC archives.

page 24 (line 3) From an interview between AGB Sutherland and Jean-Francois Delafresnaye, IARC archives.

pages 27–28 (“Places, names, and dollars”) From minutes of meetings, IARC archives.

page 29 (lines 13–20) From minutes of meetings, IARC archives.

page 31 (“The first IARC Scientific Council”) From Sohier R, Sutherland AGB (1990). The Origin of the International Agency for Research on Cancer. IARC Technical Report No. 6. Lyon, France: IARC. Available from: <http://www.iarc.fr/en/publications/pdfs-online/treport-pub/treport-pub6/index.php>.

page 32 (lines 2–3) From letter from Richard Doll to John Higginson, IARC archives.

page 35 (line 5) From John Gray’s address at the inauguration of the IARC new building in 1972, IARC archives; (lines 8–10) From IARC archives.

page 38 (lines 27–30) From Jacob F (1997). La Souris, la Mouche et l’Homme. Paris: Éditions Odile Jacob.

page 46 (Ricoeur quotation) From Ricoeur P (1992). Lectures 2, La Contrée des Philosophes. Paris: Seuil, p. 202.

page 50 (line 1) Schoenheimer R (1942). The Dynamic State of Body Constituents. Cambridge, Massachusetts: Harvard University Press.

page 51 (lines 10–11) From Klug A (1968). Rosalind Franklin and the discovery of the structure of DNA. Nature. 219(5156):808–44. <http://dx.doi.org/10.1038/219808a0> PMID:4876935.

page 52 (line 33) From Cutler SJ, Griswold MH, Shimkin MB (1956). Survival in untreated and treated cancer. Ann Intern Med. 45(2):255–67. <http://dx.doi.org/10.7326/0003-4819-45-2-255> PMID:13355149.

pages 54–55 (“Preventing cancer”) From Doll R (1967). Prevention of Cancer: Pointers from Epidemiology. London: Nuffield Provincial Hospitals Trust. Reprinted with permission. © 1967 by The Nuffield Provincial Hospitals Trust, London.

page 55 (lines 33–36) From Higginson J (1979). Cancer and environment: Higginson speaks out. Science. 205(4413):1363–4, 1366. <http://dx.doi.org/10.1126/science.472753> PMID:472753.

page 56 (line 5) Clemmesen J (1965). Statistical Studies in the Aetiology of Malignant Neoplasms: A Manual of Cancer Epidemiology. Copenhagen, Denmark: Munksgaard Publishers.

page 64 (“Health and disease are socially determined”) From WHO (2008). Closing the Gap in a Generation: Health Equity Through Action on the Social Determinants of Health: Final Report of the Commission on Social Determinants of Health. Geneva: World Health Organization. Reprinted with permission. © World Health Organization 2008.

page 100 (line 14) Plummer M (2008). Penalized loss functions for Bayesian model comparison. Biostatistics. 9(3):523–39. <http://dx.doi.org/10.1093/biostatistics/kxm049> PMID:18209015.

page 102 (lines 18–19) From Ferrari P, Carroll RJ, Gustafson P, Riboli E (2008). A Bayesian multilevel model for estimating the diet/disease relationship in a multicenter study with exposures measured with error: the EPIC study. Stat Med. 27(29):6037–54. <http://dx.doi.org/10.1002/sim.3444> PMID:18951369.

page 106 (lines 3–4) From Clemmesen J (1965). Statistical Studies in the Aetiology of Malignant Neoplasms, Vol. 1, Review and Results. Copenhagen, Denmark: Munksgaard Publishers, p. 248.

page 108 (“Cancer Incidence in Five Continents, Volume I”) From Doll R, Payne P, Waterhouse JAH, editors (1966). Cancer Incidence in Five Continents, Vol. I. Geneva: International Union Against Cancer (UICC).

page 137 (lines 2–4) From Stewart BW, Wild CP, editors (2014). World Cancer Report 2014. Lyon, France: IARC, p. xi.

page 142 (lines 9–13) From Turusov V, Rakitsky V, Tomatis L (2002). Dichlorodiphenyltrichloroethane (DDT): ubiquity, persistence, and risks. *Environ Health Perspect.* 110(2):125–8. <http://dx.doi.org/10.1289/ehp.02110125> PMID:11836138.

page 143 (lines 18–23) From Tomatis L (2002). Primary prevention protects public health. *Ann N Y Acad Sci.* 982(1):190–7. <http://dx.doi.org/10.1111/j.1749-6632.2002.tb04933.x> PMID:12562637; (lines 23–27) From Tomatis L, Huff J (2002). Evolution of research in cancer etiology. In: Coleman WB, Tsongalis GJ, editors. *The Molecular Basis of Human Cancer*. Totowa, New Jersey: Humana Press Inc., pp. 189–201; (lines 29–32) From Tomatis L (2006). Role of experimental and epidemiological evidence of carcinogenicity in the primary prevention of cancer. *Ann Ist Super Sanita.* 42(2):113–7. PMID:17033130.

page 150 (lines 1–5) From IARC (1971). *IARC Annual Report 1970*. Lyon, France: IARC, pp. 86–7.

page 151 (lines 4–5) From IARC (1976). Some naturally occurring substances. *IARC Monogr Eval Carcinog Risk Chem Man*, 10:1–342. PMID:992652.

page 156 (line 4) Doll R, Hill AB (1964). Mortality in relation to smoking: ten years' observations of British doctors. *Br Med J.* 1(5396):1460–7. <http://dx.doi.org/10.1136/bmj.1.5396.1460> PMID:14132080.

page 157 (lines 12–14) From IARC (2004). Tobacco smoke and involuntary smoking. *IARC Monogr Eval Carcinog Risks Hum*, 83:1–1438. PMID:15285078.

page 162 (lines 1–4) From Tannenbaum A, Silverstone H (1953). Nutrition in relation to cancer. *Adv Cancer Res.* 1:451–501. [http://dx.doi.org/10.1016/S0065-230X\(08\)60009-3](http://dx.doi.org/10.1016/S0065-230X(08)60009-3) PMID:13057710, © 1953, with permission from Elsevier.

pages 178–179 (Margaret Chan quotation) From World Health Organization Director-General Dr Margaret Chan's opening address at the World Conference on Social Determinants of Health, Rio de Janeiro, Brazil, 19 October 2011. Available from: http://www.who.int/dg/speeches/2011/social_determinants_19_10/en/.

page 203 (lines 8–13) From Lenoir GM, O'Connor GT, Olweny CLM, editors (1985). *Burkitt's Lymphoma: A Human Cancer Model*. IARC Scientific Publication No. 60. Lyon, France: IARC, p. 11.

page 206 (lines 4–6) From Doll R, Peto R (1981). The causes of cancer: quantitative estimates of avoidable risks of cancer in the United States today. *J Natl Cancer Inst.* 66(6):1191–308. PMID:7017215.

page 208 ("1989: Cervical cancer and infection – growing evidence amid much uncertainty") From Muñoz N, Bosch FX, Jensen OM, editors (1989). *Human Papillomavirus and Cervical Cancer*, IARC Scientific Publication No. 94. Lyon, France: IARC.

page 215 ("Liver cancer as seen in 1969") From IARC (1971). *Liver Cancer: Proceedings of a Working Conference held at the Chester Beatty Research Institute, London, England, 30 June to 3 July 1969*. IARC Scientific Publication No. 1. Lyon, France: IARC.

page 225 (lines 5–7) From Shimkin MB (1977). *Contrary to Nature*. Washington, DC: United States Department of Health, Education and Welfare, p. 384.

page 245 (lines 8–9) From IARC (1971). *Liver Cancer: Proceedings of a Working Conference held at the Chester Beatty Research Institute, London, England, 30 June to 3 July 1969*. IARC Scientific Publication No. 1. Lyon, France: IARC, p. 5.

IARC DIRECTORS AND COUNCIL CHAIRS

IARC DIRECTORS

John Higginson (1966–1981)

Lorenzo Tomatis (1982–1993)

Paul Kleihues (1994–2003)

Peter Boyle (2004–2008)

Christopher Wild (2009–present)

GOVERNING COUNCIL CHAIRS

E.J. Aujaleu, France (1965–1967)

R.J.H. Kruisinga, Netherlands (1968–1970)

J.A.B. Gray, United Kingdom (1971–1973)

N.N. Blokhin, Soviet Union (1974–1975)

S. Halter, Belgium (1976–1977)

H. Voigtländer, Federal Republic of Germany (1978–1979)

R. Vannugli, Italy (1980–1981)

G.T. O'Connor, USA (1981–1983)

B.P. Kean, Australia (1984–1985)

E. Somers, Canada (1986–1988)

H. Danielsson, Sweden (1989–1990)

J.K. Huttunen, Finland (1991–1992)

H. Voigtländer, Germany (1993–1994)

B. Mørland, Norway (1995–1996)

A. Adams, Australia (1997–1998)

T. Zeltner, Switzerland (1999–2000)

D. Dunstan, United Kingdom (2001–2002)

J. Larivière, Canada (2003–2004)

J.W. Hartgerink, Netherlands (2004–2006)

L.E. Hanssen, Norway (2007–2010)

P. Puska, Finland (2011–2013)

M. Palmer, United Kingdom (2014–present)

SCIENTIFIC COUNCIL CHAIRS

- O. Mühlbock, Netherlands (1965)^a
- W.R.S. Doll, United Kingdom (1966–1967)
- H. Hamperl, Federal Republic of Germany (1967)
- I. Berenblum, Israel (1968)
- P.F. Denoix, France (1969)
- N.N. Blokhin, Soviet Union (1970)
- C.G. Schmidt,
Federal Republic of Germany (1971)^b
- R. Latarjet, France (1972)
- D.W. Van Bekkum, Netherlands (1973)
- B.E. Gustafsson, Sweden (1974–1975)
- G.L. Ada, Australia (1976)
- A.C. Upton, USA (1977)
- S. Eckhardt, Hungary (1978)
- K. Munk, Federal Republic of Germany (1979)
- J. Miller, Australia (1980)
- M. Tubiana, France (1981)
- J. Cairns, United Kingdom (1982)
- N.E. Gray, Australia (1983–1984)
- A.B. Miller, Canada (1985)
- H.J. Evans, United Kingdom (1986)
- B.K. Armstrong, Australia (1987)
- R. Simard, Canada (1988)
- R. Monier, France (1989)
- E.J. Saksela, Finland (1990)
- A.J. McMichael, Australia (1991–1992)
- L.G. Israels, Canada (1993)
- T. Sanner, Norway (1994–1995)
- A.C. Green, Australia (1996)
- A.R. Sarasin, France (1997)
- J.C. Barrett, USA (1998)
- H.E. Blum, Germany (1999)
- J.L. Hopper, Australia (2000)
- C. Bonāiti-Pellié, France (2001)
- M. Aguet, Switzerland (2002)
- L.K. Borysiewicz, United Kingdom (2003–2004)
- J.D. Potter, USA (2005–2006)
- B. Ponder, United Kingdom (2007–2008)^c
- J. Siemiatycki, Canada (2009)
- H. Comber, Ireland (2010)
- E.J. Rivedal, Norway (2011)
- I. Frazer, Australia (2012)
- M. Melbye, Denmark (2013–2014)
- C. Ulrich, Germany (2015)

^a First meeting of the Scientific Committee.

^b Elected chair after the death of J.H.F. Maisin.

^c Could not attend; was replaced by the vice-chair (J. Siemiatycki, Canada, in 2007 and E. Ron, USA, in 2008).



The International Agency for Research on Cancer (IARC) was born of a big idea: to redirect some of the vast sums of money that the most powerful nations were investing in their military might after the Second World War, and to use these funds not to fight each other but to fight together against a common enemy: cancer. Cooperation, not conflict.

Although the financial model never materialized, the second component of the big idea – a spirit of cooperation – was realized, and flourished. Since its creation in 1965 as the specialized cancer agency of the World Health Organization, IARC has conducted research worldwide and helped thousands of cancer researchers from developing countries hone their skills through fellowships, courses, and collaborative projects.

This book charts the birth of IARC during the 1960s – a period of great optimism for international cooperation and medical science. It goes on to describe the Agency's major achievements over the past five decades in terms of the development of tools for conducting cancer research, the identification of risk factors, and the evaluation of preventive interventions.

By examining IARC's history, the authors illustrate how, despite the changing landscape of cancer research, the original vision continues to be a valid response to the needs for cancer prevention and control worldwide. This is ever more the case as the disease burden falls more heavily on developing countries, and international collaborative studies are increasingly relied upon to address national priorities for cancer control.