

*Full Length Research Paper*

# The effects of different distributor head types, air velocities and fertilizing rates on flow evenness for some fertilizers

Ibrahim Ethem Guler

Department of Farm Machinery, Faculty of Agriculture, Ataturk University, 25240 Erzurum, Turkey.  
E-mail: [iguler@atauni.edu.tr](mailto:iguler@atauni.edu.tr). Tel: 0900442-2312691. Fax: 0900442-2360958.

Accepted 17 August, 2010

**In this study, three different types of distributor head (T, funnel and Y) were tested at three air velocities of 26, 31 and 36 ms<sup>-1</sup>, and three different fertilizing rates were selected as 12, 16 and 20 kg da<sup>-1</sup> for two different fertilizers having nitrogen (calcium ammonium nitrate and urea). The best results of flow evenness were obtained with the T type distributor head at the air velocity of 26 m s<sup>-1</sup> and fertilizing rate of 20 kg da<sup>-1</sup> for both calcium ammonium nitrate and urea. In addition, an increase in fertilizing rate had a positive effect on flow evenness.**

**Key words:** Air velocity, distributor head, fertilizing rate, flow evenness, fertilizer.

## INTRODUCTION

Soil fertilization is carried out by means of organic matters which were in the form of mineral fertilizers of various kinds. Mineral fertilizers can be spread all over the land surface or underground (Bernacki et al., 1972; Kepner et al., 1972). The effectively usage of the fertilizers from both plant requirements and the economics is very important. The suitable use of fertilizers is possible with the distribution of fertilizers to the root of plant and the distributing uniformity of fertilizers in the necessary application rates of the necessary amount of plants.

The different machines were used in distributing of mineral fertilizers. According to supplying soil of fertilizers, the structural properties and working rules of these distributors were differed with each other. The fertilizers may be applied before planting during soil tillage or the seed bed preparation, during planting, and after germination during the active growth period (Srivastava et al., 1993). Fertilizer distributors for a good fertilization have to meet the uniformity in distribution, the possibility of controlling the amount of fertilizer distribution, a relatively slight dependence of the amount

of the application rate on shocks and inclination of the machine during its operation, insensibility of working elements of distributor to corrosive action of fertilizers (Hansen et al., 1962; Bernacki et al., 1972; Kepner et al., 1972).

In spite of the fluid fertilizers in the developed countries, the fertilization was applied commonly with solid mineral fertilizers. Application of mineral fertilizers has certain advantages. The equipments for applying granular fertilizers include drop type (gravity), rotary (centrifugal) and air (pneumatic) spreader. Pneumatic applicators have a centrally located hopper from which granules are metered, delivered by air through tubes across the width of the machine. The pneumatic applicator can be used for either broadcast or band application (Srivastava et al., 1993). The fertilizers in bulk can be applying better than with packing fertilizer for having a centrally located hopper of the pneumatic applicators (Heege and Ruhle, 1967).

The basic performance parameter for a fertilizer distributor is uniformity of distribution over a wide range of conditions. The uniformity of distribution determines labor quality of the applicator. If the fertilizer distribution is proper, the labor quality of the applicator will improve better. As flow unevenness of fertilizer increases crop yield and net profit decreases. The flow evenness can be determined with many methods. The most used common

**Abbreviations:** CAN, Calcium ammonium nitrate; UREA, urea; CV, coefficient of variation; LSD, least significant difference.

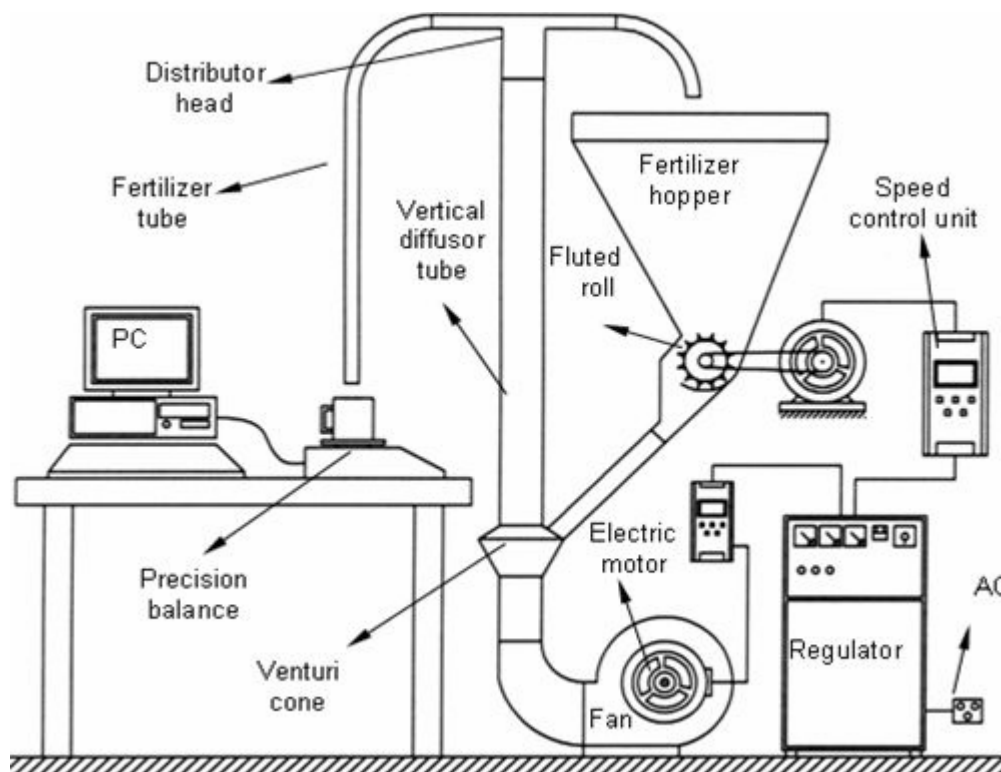

Figure 1. Measurement setup.

method is the Coefficient of Variation (CV) (Speelman, 1979). Aim of this study, the effects of three different types of distributor head, three different air velocities and fertilizing rates on the flow evenness of two different fertilizers transported with air in a pneumatic experiment set were determined.

## MATERIALS AND METHODS

The experiment set which has pneumatic system was used for the obtained data with the fertilizers distribution during the tests (Figure 1). This experiment set was manufactured at the Department of Farm Machinery in Faculty of Agriculture of Ataturk University. The experiments were conducted in the laboratory conditions. Fertilizers having nitrogen (N) used in the experiments were Calcium Ammonium Nitrate (CAN) and Urea (UREA).

Three distributor heads (T, funnel and Y) were used in the experiments. There are nine outlet tubes in each distributor head. The distributor heads were taken shape from flat black steel in thickness 1.5 mm. Inlet tube inside diameter of distributor head is 75 mm and outlet tube inside diameter of each distributor head is 30 mm. The technique and constructive properties of the distributor heads are given in Figures 2a, 2b and 2c. The air velocities in the tests are 26, 31 and 36 m s<sup>-1</sup> and were measured with an anemometer.

The fertilizing rates used in the experiments are 12, 16 and 20 kg da<sup>-1</sup>. The ground speed was 1.5 m s<sup>-1</sup> and the row distance was 15 cm (Lafond and Derksen, 1996; Pageau, 1996; Sapsford, 1996; Roberts et al., 2001). Total fertilizer rates flowed the fluted feed rolls were obtained as flow rate (g s<sup>-1</sup>) for each fertilizer (Anonymous,

1989a).

In the experiments, diffuser tube having the different distributor heads was always vertical and outlet fertilizer tubes were equal length. Fluted feed rolls which have the most proper flow evenness of the fertilizer and to be adjusting the active roll length were used in the experiment set (Ozsert, 1992). In addition, in order to get continuity flow of flowed fertilizer from fluted feed roll at determining the active roll length was run at fluted roll speeds of 20 to 40 min<sup>-1</sup> during the tests (Turgut et al., 1996; Guler, 2005).

The fluted feed roll was worked asynchrony electric motor with variable speed which has 4 kW forces. Moreover, a speed control unit at 4 kW forces was used for adjusting of the fertilizing rate. Radial fan which gives air was moved with a three phase electric motor at 0.75 kW forces. Another speed control unit at 1.5 kW forces was used for the different air velocities. During the tests the precision balance was placed just under the fertilizer tubes, and the fertilizers flowed with the aid of air from the different distributor heads were weighed continuously and cumulatively by a precision balance and the data were transmitted to PC in a continuous stream by the RC 232 C interface circuit of the balance. The balance can automatically weigh in accuracy of 0.01 g and its transfer rates are selectable from 300 to 4800 bauds (Ozsert et al., 1988; Ozsert, 1992; Turgut et al., 1994). The time of scaling-recording was selected as 0.1 s in order to weigh the material as it flowed. For each test, at least 200 values were taken from the balance and the fertilizer flow along a 30 m row was determined (Turgut et al., 1995). Each test was replicated 3 times. Arranging the data transmitted to PC for each test by EXCEL program, the amounts of the flowing material in each scaling interval were determined in weight. Average flow rate ( $\bar{X}$ ), standard deviation (S) and coefficient of variation (CV, %) were determined for each repetition. The statistical analyses were done by MINITAB and

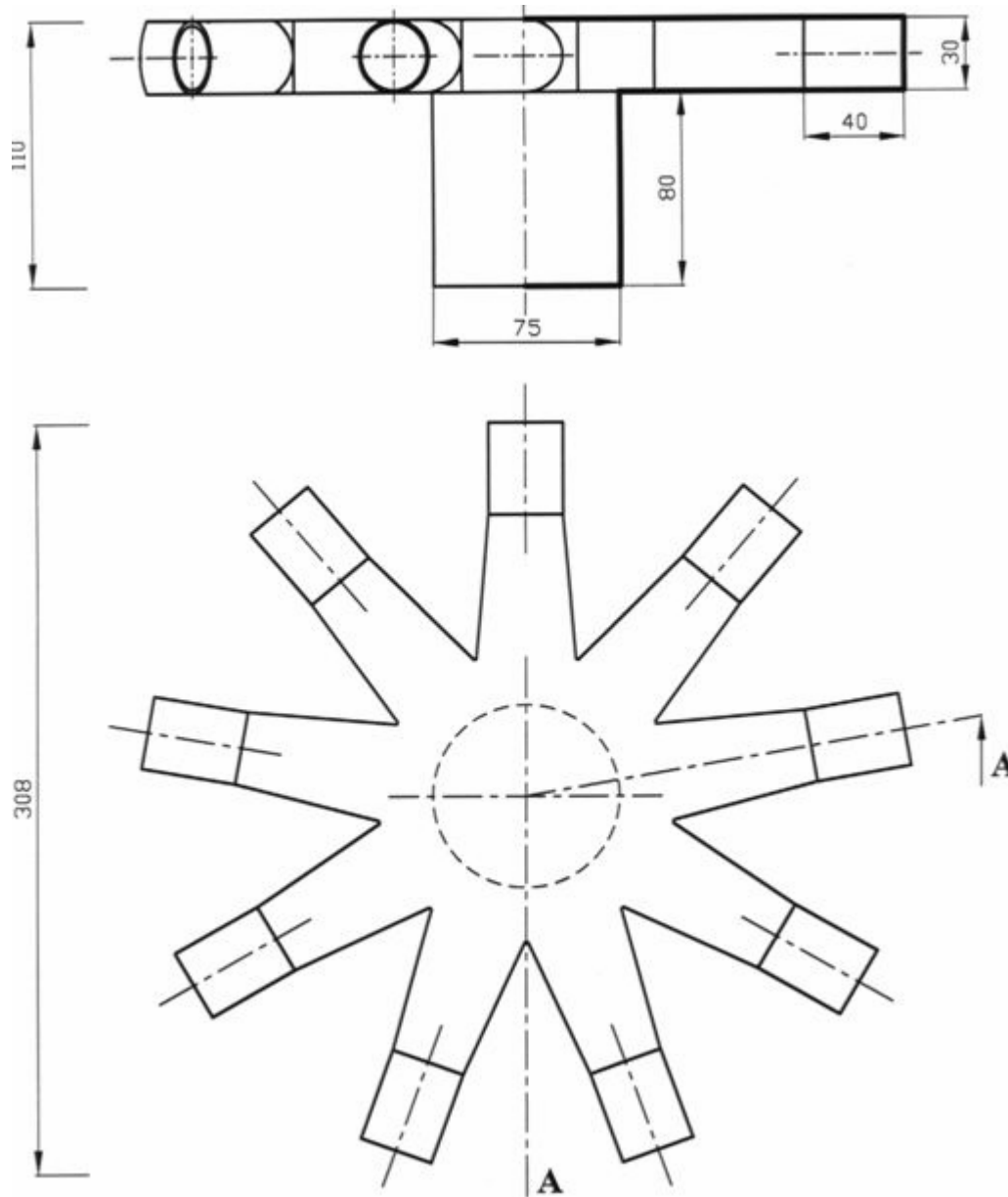

Figure 2a. Constructive properties of T distributor head.

MSTAT-C for the obtained values of flow rate and coefficient of variation (CV, %) as an explaining of flow evenness and the graphs were drawn by EXCEL (Anonymous, 1989b; Anonymous, 2000).

## RESULTS AND DISCUSSION

Flow rate ( $\text{g s}^{-1}$ ) and flow evenness (CV, %) were determined for each distributor head. The variance analyses to these values obtained at the different distributor heads, the air velocities and the fertilizing rates for CAN and UREA are presented in Tables 1 and 2. Table 1 shows that, the distributor head, the air velocity, the fertilizing rate and their interactions had a very

significant effect ( $P < 0.01$  for CAN) on flow rate. But interaction between air velocity and fertilizing rate was found significant ( $P < 0.05$ ). However, the effect of variation sources has been differently obtained for CV. The distributor head was found significant ( $P < 0.05$ ) while the air velocity, the fertilizing rate and interaction between distributor head and air velocity have been found very significant ( $P < 0.01$  for CV, %). In the variance analyses investigated as UREA (Table 2), the effects on both flow rate and CV% of variation sources were very significant effect ( $P < 0.01$ ). The results of Least Significant Difference (LSD) test are presented in Table 3 for every two fertilizer. The performance curves

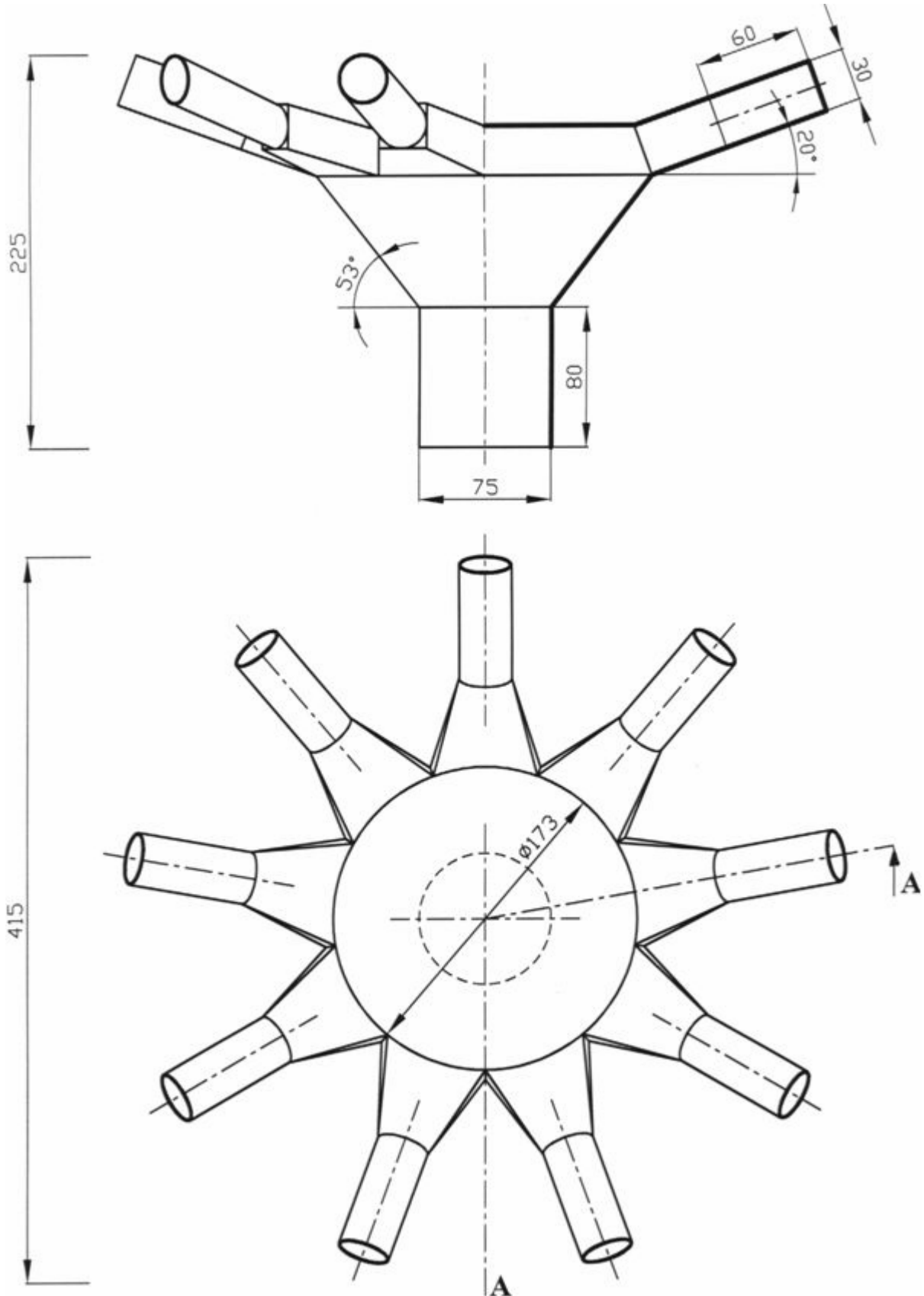
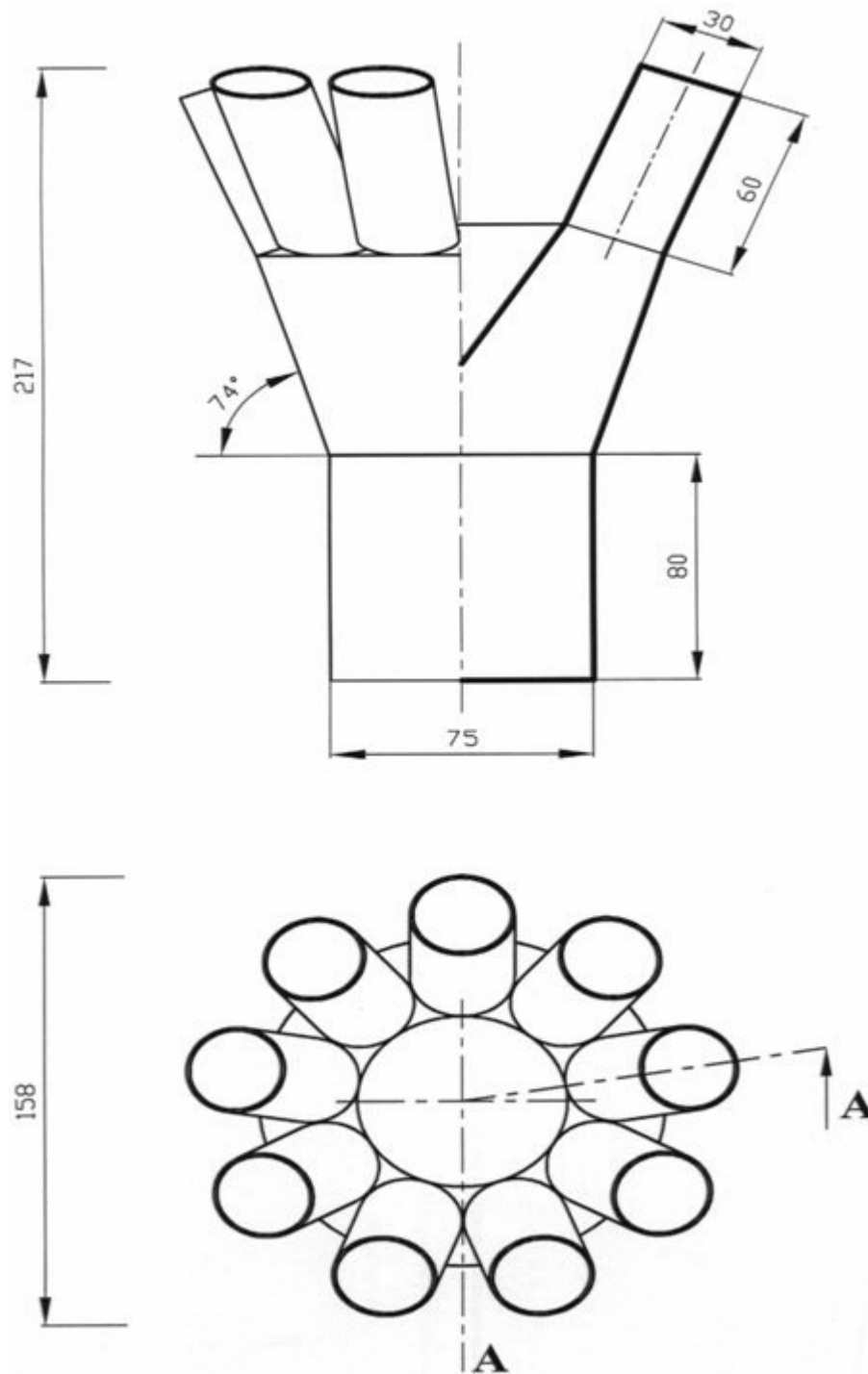

Figure 2b. Constructive properties of funnel distributor head.



**Figure 2c.** Constructive properties of Y distributor head.

obtained from the flow rates and CV for CAN and UREA are presented in Figures 3-6.

The flow rate values ( $\bar{x}$ ) obtained from the all distributor heads (T, funnel and Y) were between 1.1 and 2.4  $\text{g s}^{-1}$  for CAN (Figure 3). As UREA, these values were between 0.7 and 1.6  $\text{g s}^{-1}$  (Figure 4). These figures show

that, the flow rate values of CAN are much higher than UREA. The differences in the flow rates values are between 33 and 36%. The lowest and the highest values for UREA were found between 13.05 and 56.33% while the values of CV for CAN varies from 11.31 to 35.99% (Figures 5 and 6). 67% of the CV values for CAN and

**Table 1.** The variance analysis of CAN for flow rate ( $\text{g s}^{-1}$ ) and flow evenness (CV, %).

Sources	DF	Flow rate			CV		
		MS	F	P	MS	F	P
Distributor head (DH)	2	0.06886	33.44	0.000 **	29.717	4.22	0.020 *
Air velocity (AV)	2	0.07683	37.31	0.000 **	309.743	44.00	0.000 **
Fertilizer rate (FR)	2	5.81813	2825.39	0.000 **	637.532	90.57	0.000 **
DH x AV	4	0.08042	39.05	0.000 **	54.638	7.76	0.000 **
AV x FR	4	0.00565	2.75	0.038 *	14.990	2.13	0.090
DH x FR	4	0.01189	5.78	0.001 **	4.342	0.62	0.652
DH x AV x FR	8	0.01356	6.58	0.000 **	19.793	2.81	0.011 *
Error	54	0.00206			7.039		

\*\* =  $P < 0.01$ , \* =  $P < 0.05$  in level significant.

**Table 2.** The variance analysis of UREA for flow rate ( $\text{g s}^{-1}$ ) and flow evenness (CV, %).

Sources	DF	Flow rate			CV		
		MS	F	P	MS	F	P
Distributor head (DH)	2	0.16661	182.83	0.000 **	422.24	55.98	0.000 **
Air velocity (AV)	2	0.00582	6.39	0.003 **	712.09	94.40	0.000 **
Fertilizer rate (FR)	2	2.96024	3248.52	0.000 **	1299.59	172.29	0.000 **
DHXAV	4	0.02045	22.44	0.000 **	119.04	15.78	0.000 **
AVXFR	4	0.02567	28.17	0.000 **	80.77	10.71	0.000 **
DHXFR	4	0.01270	13.94	0.000 **	65.68	8.71	0.000 **
DHXAVXFR	8	0.02107	23.13	0.000 **	46.19	6.12	0.000 **
Error	54	0.00091			7.54		

\*\* =  $P < 0.01$ , \* =  $P < 0.05$  in level significant.

**Table 3.** Results of LSD tests for the fertilizers used in the experiments.

Sources		Can		Urea	
		Flow rates ratesakıs miktari ort.	CV %	Flow rates	CV %
Distributor head	T	1.6347c <sup>√</sup>	18.866ab	1.1435c	21.097b
	funnel	1.7354a	20.201a	1.2972a	27.200a
	Y	1.6917b	18.132b	1.1920b	19.793b
Air velocity	26 $\text{m s}^{-1}$	1.6733b	15.950c	1.1940b	18.669c
	31 $\text{m s}^{-1}$	1.7462a	18.579b	1.2207a	20.941b
	36 $\text{m s}^{-1}$	1.6423b	22.671a	1.2180a	28.480a
Fertilizer rate	12 $\text{kg da}^{-1}$	1.2280c	24.175a	0.8715c	30.264a
	16 $\text{kg da}^{-1}$	1.6776b	18.522b	1.2282b	21.188b
	20 $\text{kg da}^{-1}$	2.1562a	14.503c	1.5330a	16.637c
LSD values ( $P = 0.01$ )		0.03298	1.928	0.02192	1.995

<sup>√</sup>= Averages showed with same letter are not significant.

48% for UREA were within the acceptable limits (Guler, 2005). The values of CV obtained from T and Y distributor

heads were found less according to the values of funnel distributor head. On the other hand, acceptable CV values

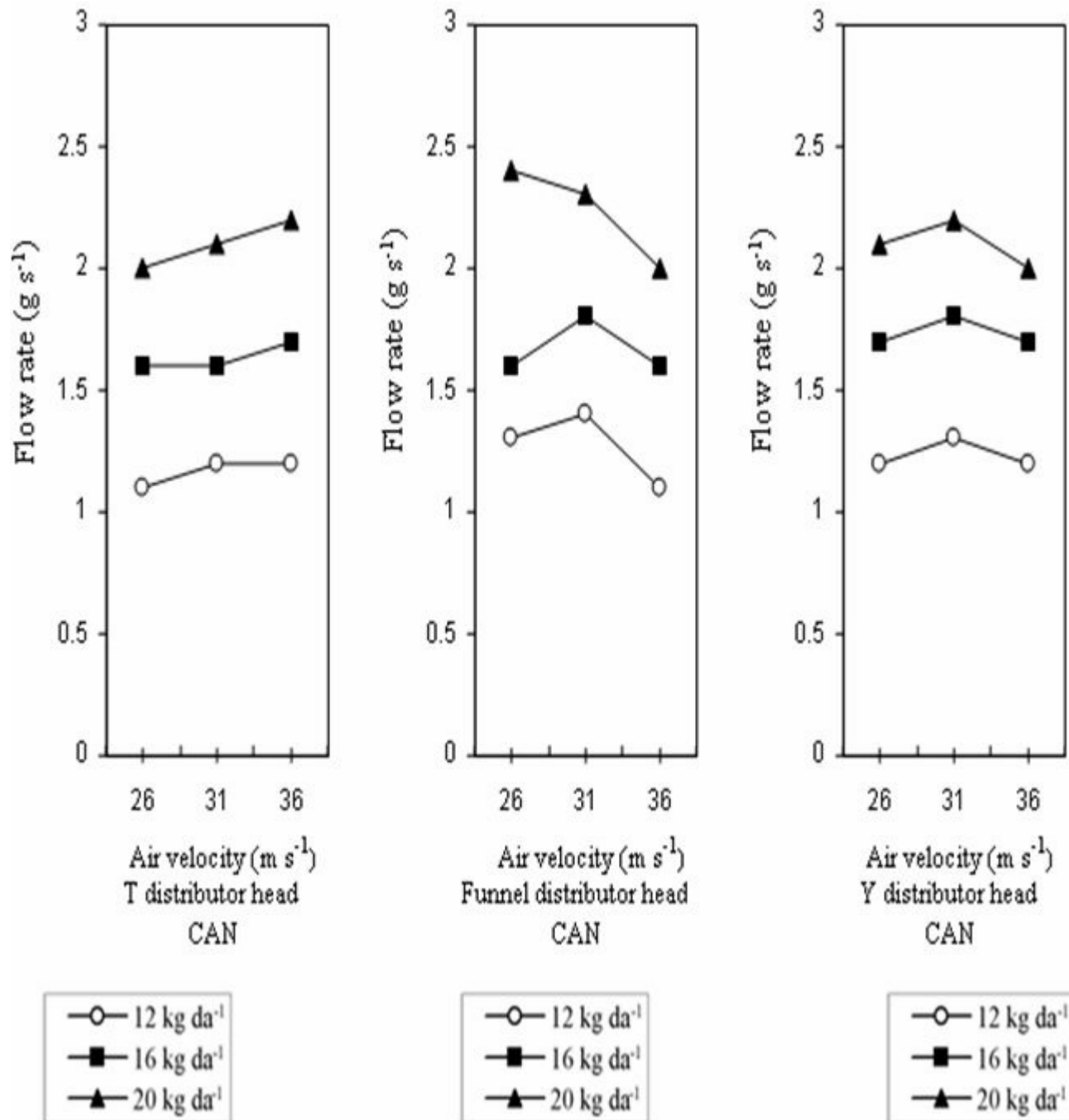
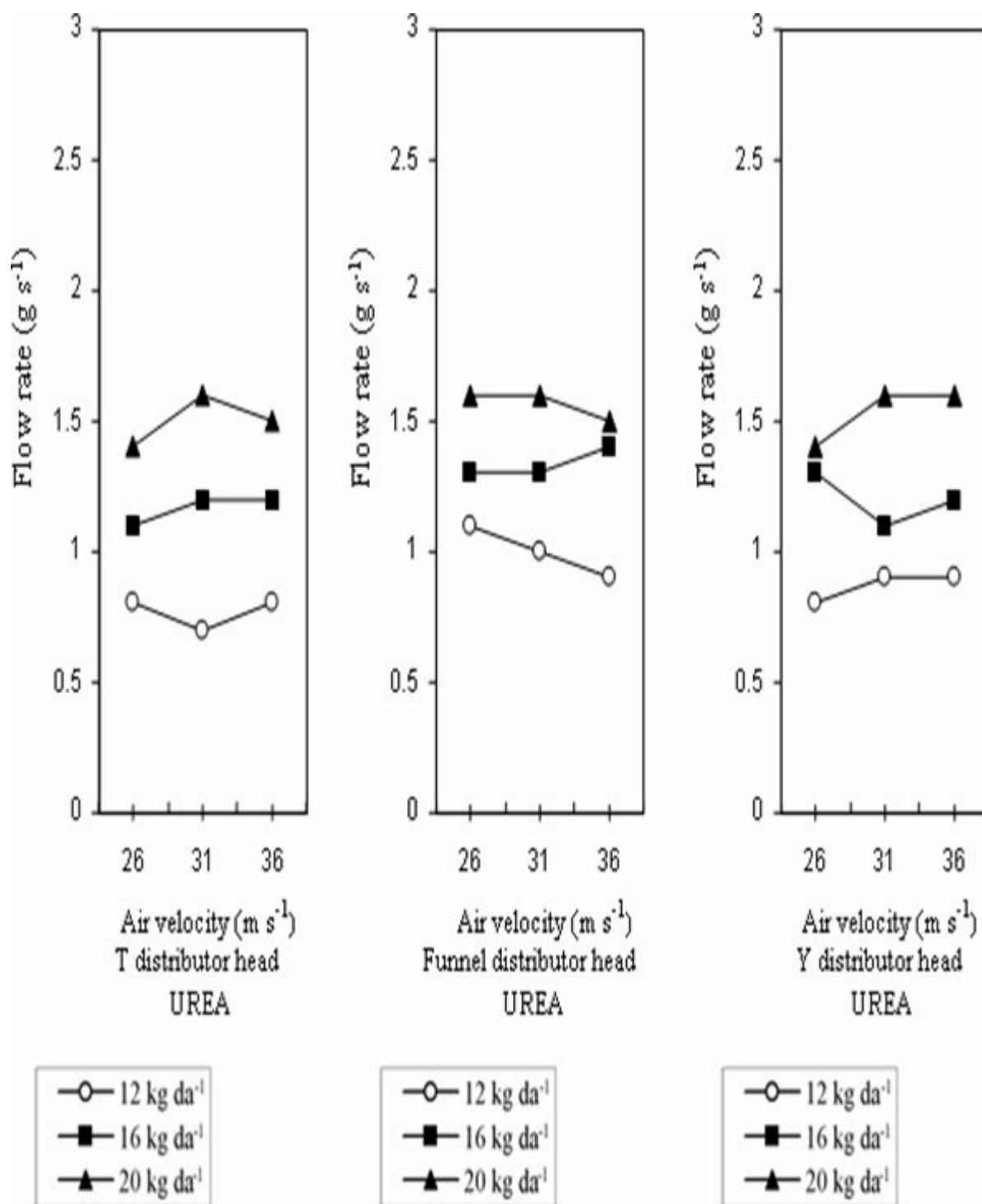

Figure 3. Curves related to the flow rates in different distributor heads, air velocities and fertilizer rates for CAN.

were between 10 and 20% (Guler, 2005). The values of CV obtained in the air velocity 26 m s<sup>-1</sup> for every three distributor heads were within the acceptable limits. The values of CV obtained from 36 m s<sup>-1</sup> are higher than according to the values of the other air velocities (26 and 32 m s<sup>-1</sup>). Therefore, the values obtained in this air velocity are unacceptable level (> 20 %). The values of CV obtained in the fertilizing rate 20 kg da<sup>-1</sup> for every

three distributor heads were within the acceptable limits. The highest CV value was found the fertilizing rate 12 kg da<sup>-1</sup> and the CV value of this fertilizing rate is unacceptable level (> 20 %).

The flow rate generally increases as the fertilizing rate increases. The increase of the flow rates with the increase of the air velocity is unstable. The relation between the flow rate and the air velocity is found



**Figure 4.** Curves related the to flow rates in the different distributor heads, air velocities and fertilizer rates for UREA.

insignificant. The flow rates obtained from the distributor head types differ with each other. Flow rates of funnel distributor head have high level for both CAN and UREA. The flow rates obtained from the T and Y distributor heads are closed to one other.

The values of the coefficient of variation (CV, %) that was an indicator of the flow evenness decrease as the fertilizing rates increase. On the other expression, an even flow was obtained (Ozsert et al., 1988; Turgut et al., 1995; Guler, 2005). But, the values of CV, % increase as



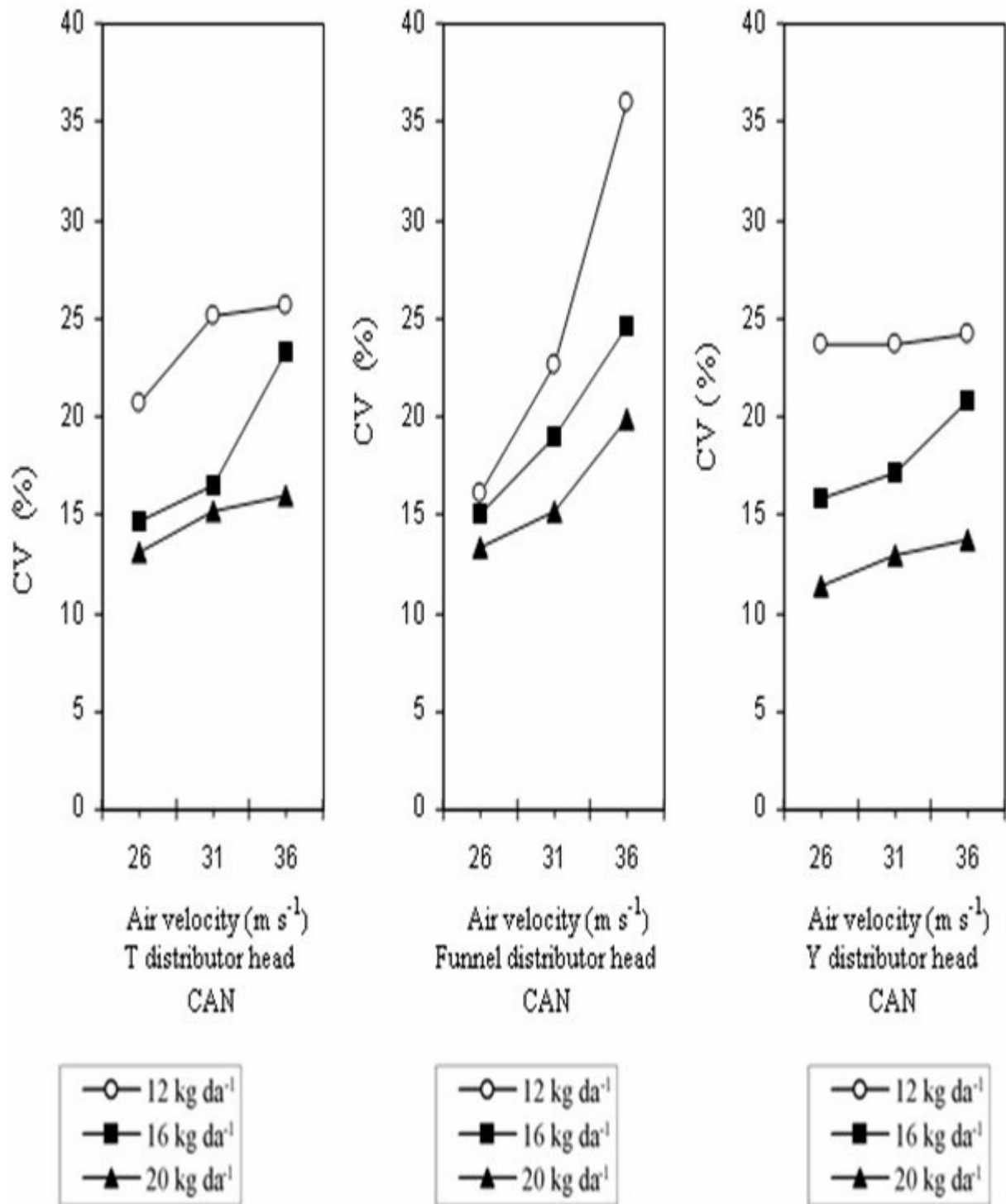
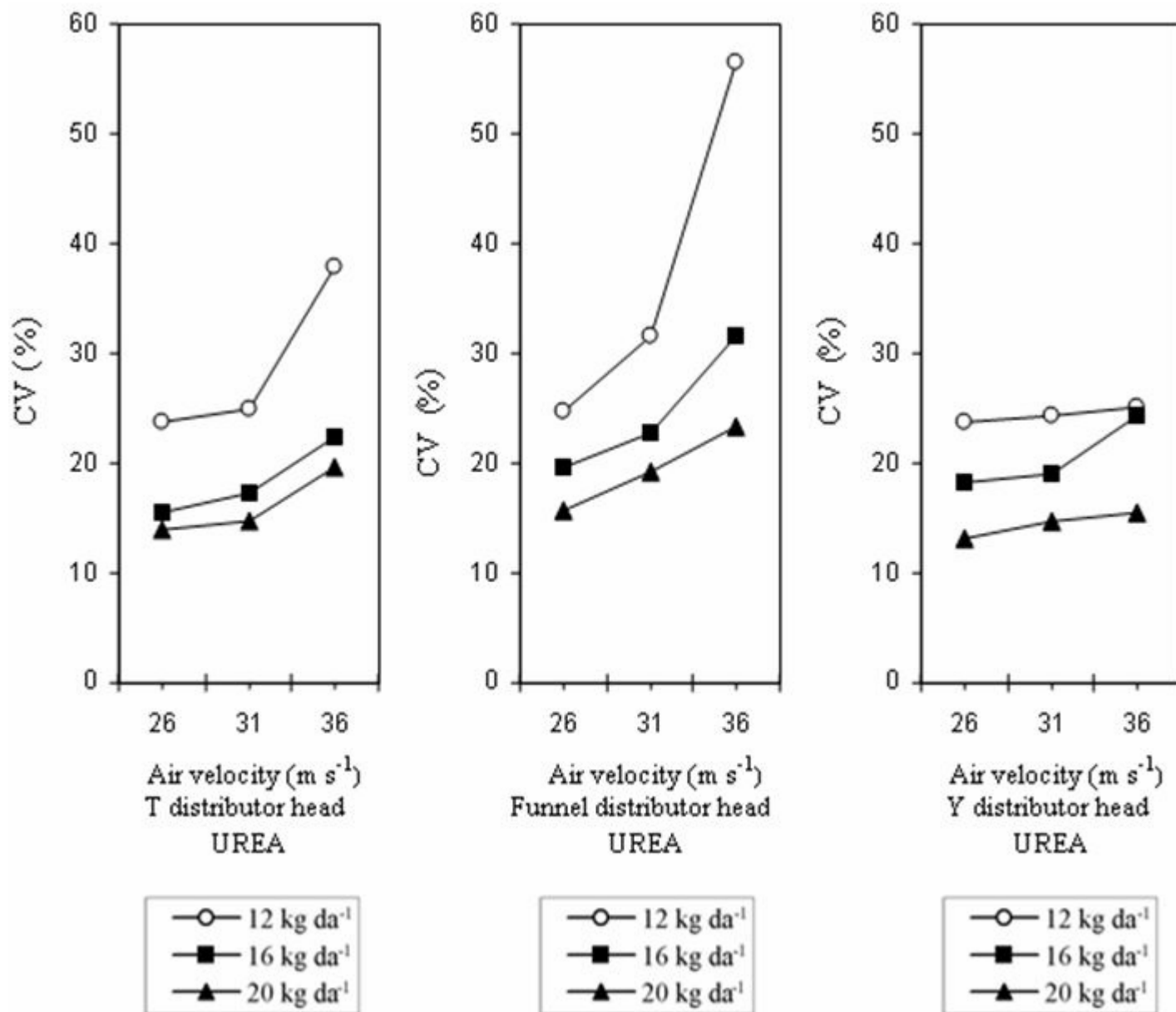

Figure 5. Curves related to the CV, % values in the different distributor heads, air velocities and fertilizer rates for CAN.

the air velocities increase. Thus, the flow evenness is unacceptable for all distributor heads.

The acceptable values of CV obtained from CAN used T, funnel and Y distributor heads are found both the fertilizing rate of 20  $\text{kg da}^{-1}$  and every three air velocities.

However, these values for 16  $\text{kg da}^{-1}$  are obtained only two air velocities for the same fertilizer. But, the values of CV for 12  $\text{kg da}^{-1}$  are also out of the acceptable limits for every three air velocities. The similar results are shown both the T and Y distributor head. The highest values of



**Figure 6.** Curves related to the CV, % values in the different distributor heads, air velocities and fertilizer rates for UREA.

CV were obtained for funnel distributor head, particularly, in air velocities of 31 and 36  $\text{m s}^{-1}$ , and the fertilizing rate of 12 and 16  $\text{kg da}^{-1}$ .

The values of CV obtained from UREA are the similar to CAN. The values of CV obtained from the fertilizing rates and the air velocities have the similar results with each other for T and Y distributor head. But, the values of CV are differed for funnel distributor head. As a result, the similar values of CV were obtained for CAN and UREA at the T, funnel and Y distributor heads. These results can be much similar to that of the physical and the mechanical properties of the fertilizers used in the experiments.

## REFERENCES

- Anonymous (1989a). Türk Standartları TS 6425 [Turkish Standarts TS 6425]. Türk Standartları Enstitüsü, Ankara.
- Anonymous (1989b). MSTAT-C, Dynamics Corporation, Highway Contract, Canyon Lake, Texas, USA.
- Anonymous (2000). MINITAB Statistical Software Release 13.32. Minitab Inc., USA.
- Bernacki H, Haman J, Kanafojski CZ (1972). Agricultural Machines, Theory and Construction 1. U.S. Department of Commerce. N.T.I.S., Springfield, Virginia.
- Guler IE (2005). Effects of flute diameter, fluted roll length, and speed on alfalfa seed flow. *Appl. Eng. Agric.*, 21(1): 5-7.
- Hansen CM, Robertson LS, Retzer HJ, Brown HM (1962). Grain drill design from an agronomic standpoint. *Transactions ASAE*, 5(1):8-10.
- Heege HJ, Ruhle K (1967). Düngerverteilung durch pneumatische

- Streugeräte. Grund. D. Landtechnik Bd., 26(1976). 6: 222-230.
- Kepner RA, Bainer R, Barger EL (1972). Principles of Farm Machinery. Second Edition, the AVI Publishing Company, INC. Westport, Connecticut.
- Lafond GP, Dersken DA (1996). Row spacing and seeding rate effects in wheat and barley under a conventional fallow management system. Canadian J. Plant Sci., 76: 791-793.
- Özsert İ, Bayhan AK, Aksu İ (1988). Bazi tahil ekim makinaları dağıtım düzenlerinin sıra üzeri dağılım düzgünlükleri üzerinde bir araştırma [A research on the longitudinal seed distribution of the delivery mechanisms of some drills]. Atatürk Üniversitesi Araştırma Fonu, Proje No: 1988/19, Erzurum.
- Özsert İ (1992). Bazi gübre dağılım düzenlerinde sıra üzeri dağılım düzgünlükleri [The longitudinal fertilizer distribution patterns of some delivery mechanisms]. Tarımsal Mekanizasyon 14. Ulusal Kongresi (2-6 Eylül 1996) Bildiri Kitabı, Samsun, pp. 125-142.
- Pageau D (1996). Effect of barley seeding rate and row spacing on control of quackgrass. Canadian J. Plant Sci., 76(4): 921-926.
- Roberts JR, Peeper TF, Solie JB (2001). Wheat row spacing, seeding rate and cultivar affect interference from rye. Weed Technol., 15(1).
- Sapsford K (1996). Row spacing for direct seeding. The Saskatchewan Soil Conservation Association (SSCA), Issue 19.
- Speelman L (1979). Features of a reciprocating spout broadcaster in the process of granular fertilizer application. Mededelingen Landbouwhogeschool Wageningen 79-8(1979), Nederland.
- Srivastava AK, Goering CE, Rohrbach RP (1993). Engineering Principles of Agricultural Machines. 2950 Niles Road, St. Joseph, Michigan (ASAE), USA.
- Turgut N, Özsert İ, Kara M (1994). The longitudinal seed distribution of some delivery mechanisms in Turkey. International of Agrophysics 8(1): 147-154.
- Turgut N, Özsert İ, Kara M, Yıldırım Y (1995). Oluklu itici makaralı gübre dağıtım düzenlerinde uygun makara boyutlarının belirlenmesi [Determination of Optimum Sizes of Fluted Roll in Fertilizer Metering]. Tarımsal Mekanizasyon 16. Ulusal Kongresi (5-7 Eylül) p. 529-537, Bursa.
- Turgut N, Özsert İ, Kara M, Güler İE (1996). Performance of fluted feed rolls in seed drills. 6. Uluslararası Tarımsal Mekanizasyon ve Enerji Kongresi, Ankara, pp. 344-352.