



THE POSSIBILITY OF INCREASING THE QUANTITY OF OXYGENATES IN FUEL BLENDS WITH NO DIESEL ENGINE MODIFICATIONS

Laurencas Raslavičius¹, Žilvinas Bazaras²

¹Lithuanian University of Agriculture Institute of Agro-Engineering, Instituto g. 20, 54132 Raudondvaris, Kaunas region, Lithuania

²Dept of Mechanical Technology, Kaunas University of Technology Panevėžys Institute, S. Daukanto g. 12, 35212 Panevėžys, Lithuania

E-mails: ¹Laurencas.Raslavicius@gmail.com; ²Zilvinas.Bazaras@ktu.lt

Received 5 May 2009; accepted 1 February 2010

Abstract. Two fuel kinds of organic origin including rapeseed methyl ester (RME) and ethanol (E) were selected for their different physical-chemical parameters to study the maximum apt volume of oxygenates to mix fossil diesel (D) and establish expectancy to apply D–RME–E blend as a fuel for the unmodified high-speed diesel engine (a combustion chamber consists of a dished piston). The objective of the article is to provide an explicit relationship between the nature of fuel composition and diesel engine operating parameters. The results of the carried out tests on the engine oriented on dynamic and emission characteristics using various portions of the before mentioned bio-components in diesel fuel are presented. Engine behaviour seemed to be improved in the presence of ethanol additives in D–RME blend with a reduction in pollutant emissions in exhaust gases, fuel consumption, ameliorated cetane number, ignition delay time and physical-chemical characteristics of the investigated compounds. The positive and negative aspects of applying bio-based additives in fossil diesel are reported and discussed.

Keywords: oxygenates, dehydrated ethanol, D–RME–E, exhaust emission, biofuel properties.

1. Introduction

The Commission of the European Union initiated a Directive (2003/30/EC) calling for a 5.75% fuel replacement by biofuels (energy base) in 2010. Currently, various standards and specifications set rather tight limits to the composition and properties of motor fuels. It should be noted that only diesel fuel containing 3–5% of biodiesel can fulfil the current fuel specification and be sold as general motor fuel.

Some blends have already received approvals for special applications. A number of different oxygenates have been considered as components of diesel fuel. These oxygenates include various alcohols, ethers, esters and carbonates (Al-Hasan and Al-Momany 2008; Lebedevas *et al.* 2009; Labeckas 2005; Polák 2004; Pikūnas *et al.* 2006; Shi *et al.* 2006; Kwanchareon *et al.* 2007; Raslavičius and Markšaitis 2007; Raslavičius 2009; Raslavičius and Bazaras 2009a and 2009b; Török 2009; Yao *et al.* 2008; Kuprys and Kugelevičius 2009; Matijošius and Sokolovskij 2009; Butkus *et al.* 2007; Lebedevas *et al.* 2007; Lingaitis and Pukalskas 2008a, 2008b; Pukalskas *et al.* 2009). Discussing the oxygenated fuels, biodiesel is the most common one and almost all prac-

tical experiences have been generated from the use of diesel/RME blends.

According to Thomson *et al.* (1998) and Van Gerpen (1996), there are several problems of applying RME to be overcome (unstable cetane number depending on storage time and participating glycerol content).

Following long-term storage, significant changes in cetane number (CN) are observed, especially in fuels distilled as a refining step. During the process of distillation, natural antioxidants such as tocopherols are removed, so that the resulting fuels are more susceptible to oxidative degeneration. Whereas the distillation step itself has no impact on cetane number, oxidation leads to a marked increase. Thus, Thomson *et al.* (1998) reported that the cetane number of rapeseed oil methyl and ethyl esters increased by more than 12% after a storage period of 24 months. It is argued that hydro peroxides formed during the oxidation of fatty acid esters are responsible for this behaviour, which appears probable, as peroxide compounds are actually discussed as cetane improver additives (Van Gerpen 1996). As a consequence, literature values for cetane numbers considerably differ and experts argue that this data is hardly comparable (Mittelbach and Remschmidt 2004).

In addition to the discussed parameters, a variable in another process influences the use of biodiesel. Basically, the process of producing biodiesel inevitably requires that after each transesterification step, the glycerol layer has to be separated and removed from the reaction mixture. However, various melted content of glycerol regularly participating in rapeseed methyl ester content can be an occasion of the foul-up of the diesel engine. Unburned glycerol residues originating on the upper part of the cylinder nearby the compression collar (see Fig. 1). The growing upscale layer may affect abrading the moving parts potentially increasing a risk of seizing.

The unburned residues also intended to form on the fuel injectors (see Fig. 2). A thick layer covered injector nozzles strongly worsening fuel spray shaping quality directly influencing the process of combustion.

The content of free glycerol in biodiesel depends on the production process and is therefore the major criterion of fuel quality. High volumes may stem from the insufficient washing of the ester product making glycerol separate during storage once methanol as the common solvent has evaporated (Mittelbach and Remschmidt 2004).

Optimizing the combustion process (i.e. reducing NO_x and PM emissions without serious compromises in fuel consumption) requires a profound knowledge of all formation processes involved. Biodiesel is an oxygenated fuel, approximately 10% by volume that exhibits cetane characteristics exceeding that of petroleum diesel fuel (Kwanchareon *et al.* 2007). Some combustion characteristics of mineral diesel and oxygenated biofuel blends are as follows: various proportions (by volume) of a rapeseed methyl ester addition to mineral diesel distinguish an increased cetane number of the blend (see Fig. 3). 5% (by volume) of ethanol used as an additive to B15 blend reduced a combustible cetane number of the mixture that became equal to fossil diesel.

Ethanol solubility in diesel is affected mainly by two factors covering temperature and water content of the blend. At warm ambient temperatures, dry ethanol blends readily with diesel fuel. However, at about 10 °C below, the two fuels separate and the above mentioned temperature limit that is easily exceeded in many parts of the world, for a large portion of the year, works against a wider application of diesel fuel–ethanol blends.

Precluding this separation can be accomplished by adding biodiesel that acts as a bridging agent through molecular compatibility and bonding to produce a homogeneous blend (Hansen *et al.* 2005; Lebedevas and Lebedeva 2009; Raslavičius and Bazaras 2009).

It was established, that small additional quantities of ethanol to pure RME intended to prolong a transesterification step of biodiesel which is to convert all remaining glycerides into the ester product. A similar situation is faced discussing blends of the three-component D–RME–E biodiesel fuel, whereas rapeseed methyl ester serves as a RME–E solvent and bio-component at the same time. The recent amendment to D–RME blends containing more than 20% of biodiesel (v/v) considers the admixtures of 5–7% (v/v) of dehydrated ethyl alcohol



Fig. 1. The underneath of the piston surface after 200 motor-hours of exploitation using pure biodiesel (Liubarskis *et al.* 2002)

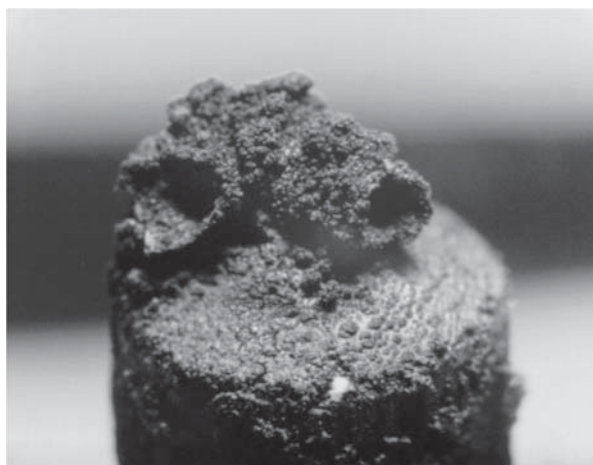

Fig. 2. An injector nozzle covered with glycerol residues after 200 motor-hours of exploitation using pure biodiesel (Liubarskis *et al.* 2002)

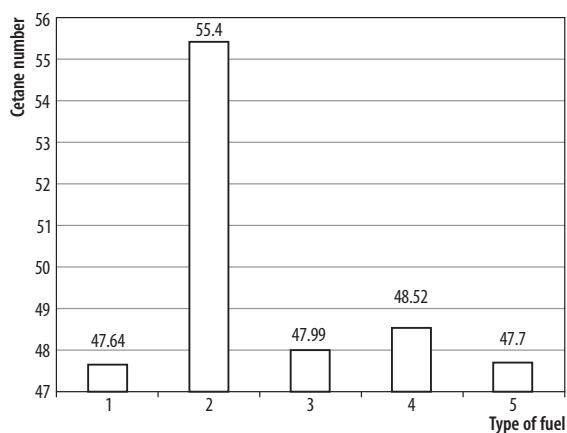

Fig. 3. Variation in cetane number subjected to the type of fuel: 1 – D; 2 – RME; 3 – B10 (90%D+10%RME); 4 – B15 (85%D+15%RME); 5 – B15+5%E

(Raslavičius and Bazaras 2009). Using RME in conjunction with ethanol allows in the complex way to increase a quantity of oxygenates to be blended with fossil diesel while no engine modifications are required to avoid possible power damages to the unit (Raslavičius 2009).

2. Objects and Methods

Rapeseed methyl ester and dehydrated ethanol were selected to study a possibility of increasing the quantity of oxygenates in D–RME–E blend. Dehydrated ethyl alcohol was obtained at Šilutė plant owned by ‘Stumbras’ (the issued Quality certificate of the obtained consignment) under the license by the State Agency of Tobacco and Alcohol Control under the Government of the Republic of Lithuania. Biodiesel was purchased at UAB ‘Rapsoila’ (Quality certificate for the obtained consignment approved by ‘Mažeikių nafta’ (Protocol No. 04–126) and UAB ‘SGS Klaipėda Ltd.’ (Protocol No. LT0430–0074)). The main requirements of the European standard for the investigated types of fuel are presented in Table 1.

For fossil diesel and RME dosage, Simax 1000-ml graduated glass conical flask with stopper was used (ISO 4788:2005, error ± 5 ml (0.5%), Class A). Ethanol additives were dosed with the help of Simax 100-ml burette with straight glass one-channel stopcock (ISO 4788:2005, error ± 0.2 ml (0.2%), Class B). The components of the tested blend were poured into the 20 l capacity tank made of pressure proof polythene and having a stopcock. Combustible compounds (see Table 2) were prepared by actively shaking the tank for about 5 minutes. A separate tank was used for the each type of fuel.

The experiments were carried out using the diesel engine D144 of 37 kW capacity (see Table 3) installed on the load stand KI 5542 (see Fig. 4). During the stand experiments, energy and emission characteristics of engine operation using multi-component fuel blends were

Table 2. The investigated fuel blends

Basic fuel	Ethanol additive, %			
	0	5.0	7.0	10.0
D	+	–	–	–
B30	+	+	+	+

Table 3. The power unit of the heavy-duty transport mean

Engine specifications	
Engine	D144, four-cycled
Engine size, cm ³	4200
Nominal revolutions, min ⁻¹	1600
Revolutions frequency range at no load condition, min ⁻¹	800–1950
Nominal power, kW	37
Number of cylinders	4
Cylinder diameter, mm	105
Stroke, mm	120
Cooling system	Air-cooling
Compression ratio	16.5
Combustion chamber	Consists of a dished piston

established. The composition of exhaust gases and brake specific fuel consumption (BSFC) rates were achieved by increasing engine load at the nominal revolution frequency of 1600 min⁻¹ (see Table 4). Depending on the varied parameter, the following characteristics were established:

- *Blend composition.* Independent variable – BSFC;
- *Engine load.* Independent variable – effective power P .

Table 1. Requirements for the investigated types of fuel: fossil diesel (LST EN 590:2004–11), RME (LST EN 14214:2009), ethanol (LST EN 15376:2008/P:2009)

Parameter	Unit	Type of fuel							
		Fossil diesel		RME			Dehydrated ethanol		
		Min.	Max.	Min.	Max.	Fact	Min.	Max.	Fact
Absolute (100 %) content	% (mass)	–	–	96.5	–	96.5	≥99.5	–	99.66
Density at 15°C	kg/m ³	820	845	860	900	884.3	780	800	791
Viscosity at 40°C	mm ² /s	2.00	4.5	3.50	5.00	4.7	–	–	1.07
Flash point	°C	>55	–	120	–	>150	–	–	21
Sulfur content	mg/kg	–	350	–	10	<3	–	50	2.54
Cetane number		51.0	–	51.0	–	51.6	–	–	8.0
Ash content	% (mass)	–	0.01	–	0.02	0.007	–	–	–
Water content	mg/kg	–	200	–	500	223	≤0.5	–	0.34
Methanol content	% (mass)	–	–	–	0.20	0.05	–	≤0.16	<0.13
Free glycerol	% (mass)	–	–	–	0.02	0.04	–	–	–
Total glycerol	% (mass)	–	–	–	0.25	0.51	–	–	–

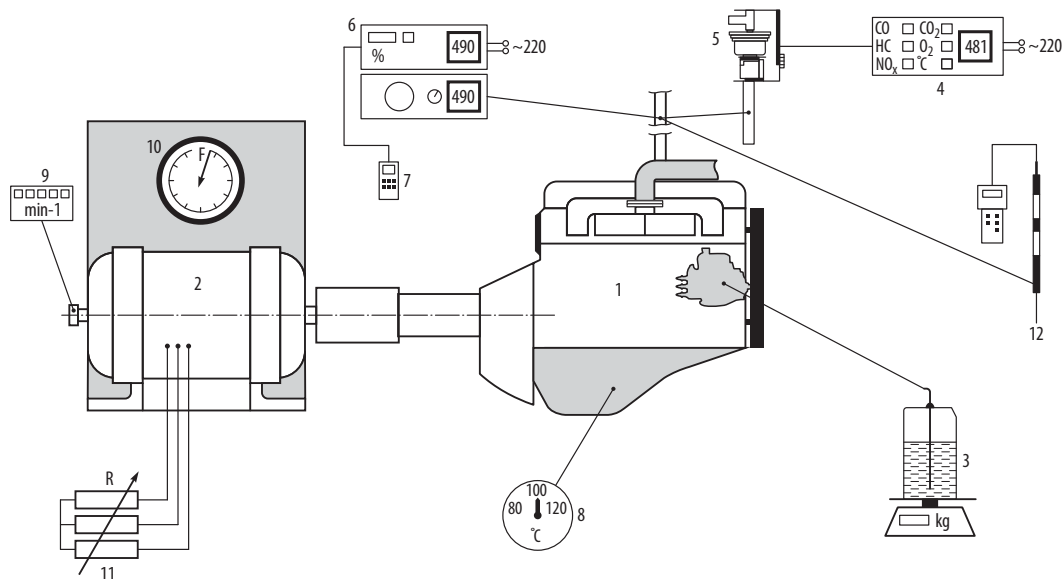

Fig. 4. Load stand scheme: 1 – diesel engine D144; 2 – generator; 3 – weighing-machine IPC-WP; 4 – Technotest 481; 5 – gas analyzer probe; 6 – Technotest 490; 7 – device for recording readings of smoke-meter; 8 – screw thermometer; 9 – TESA-1 digital tachometer; 10 – engine load measuring device; 11 – liquid-based rheostat; 12 – Bacharach PCA-65

Table 4. Variation in the operating mode of the diesel engine depending on revolution frequency and effective power

Operating mode	Revolution frequency, min^{-1}	Effective power, kW
1	1600	0
2	1600	12
3	1600	26
4	1600	32
5	1600	37

The composition of exhaust gases measured via gas analysers Technotest 481 (CO, HC) and Bacharach PCA-65 (NO_x) as well as smoke-meter Technotest 490 (PM). Before carrying out stand experiments, Technotest equipment was calibrated at Vilnius Metrology Centre according to EN 50081-1:1992 (Protocols: No 0557957 and No 0557959).

Accomplishing order for stand tests on the diesel engine:

- running at fast idling speed until the engine attains its normal working temperature;
- establishing engine speed characteristics;
- running the engine for 5–7 min in the established operating mode;
- performing measuring tests on fuel consumption and exhaust emission; depending on engine load, testing fuel consumption is accomplished as follows: measuring the time of 100 g fuel burnt out for operating mode 1 as well as the time of 200 g fuel burnt for operating modes 2–5 (see Table 3). Measuring procedures reiteration – 5 times;
- running the engine for 5–7 min at no load mode;
- engine shutdown;

- ejecting the investigated type of fuel out of the filters and supply system;
- replacing a fine filter element;
- fulfilling the supply system with the following type of fuel as well as participating air be removed with the help of a manually operating pump;
- starting-up the engine;
- running the engine at no load mode for 10–15 min. to burn out fuel residues leftover at a high-pressure pump, pipes and injectors;
- repeating straight the above mentioned procedures starting from the establishing the engine's speed characteristics.

3. Results and Discussion

All test runs were conducted on stand in steady state condition. Measurement points were chosen so that the comparison of the engine parameters and emission could be obtained for the same load but for a different proportion of ethanol to B30. Four ratios of bio-additives were respectively added into fossil diesel and used as fuel for the diesel engine. With regard to a huge quantity of the measured values, three basic loads actual for the exploitation of heavy duty transport means were selected to demonstrate the obtained results: low (6 kW), average (18 kW) and high (30 kW).

Ethanol as a compound to increase the economy of biodiesel blends. In general, engine operation on ethanol in the conducted tests on biodiesel blend posed no significant drawbacks. The brake specific fuel consumption (BSFC) of B30 blend before and after adding ethanol additives is shown in Fig. 5.

As shown in Fig. 5, in all ranges of the engine load, the lowest fuel consumption was obtained using basic fuel (B30) containing 7% (v/v) of ethanol. The brake specific fuel consumption of B30, B30+5%E and B30+10%E

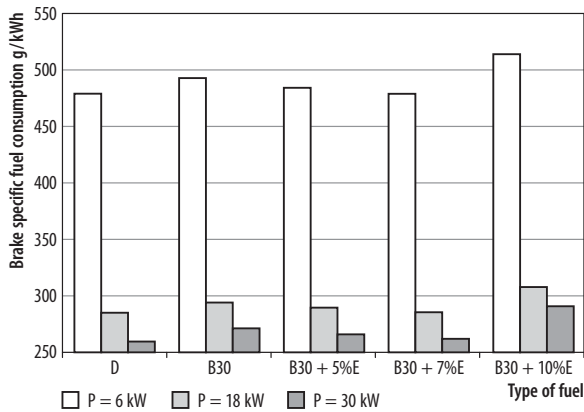

Fig. 5. Comparison of BSFC dependence on the type of fuel and engine load ($n = 1600 \text{ min}^{-1}$)

is higher than that of fossil diesel, however, when adding 7% of the total volume of ethanol to the basic fuel, they have the same fuel consumption indicating that combining various oxygenated additives can effectively improve fuel economy. It should be emphasized that after sharing 5% (v/v) of the ethanol additive, a positive effect has been achieved. The above mentioned circumstance can be explained by two factors. First, small quantities of alcohol can act as co-solvents to increase the solubility of glycerol residues in biodiesel which ensures not only better exploitation characteristics of the diesel engine but also improves the combustion process leading to fuel economy. Comparing two different types of oxygenated fuel additives to fossil diesel, we must admit that the inter-solubility of components in the D–RME–E system was substantially high and show the optimal results. Second, the presence of the small quantities of ethanol, due to its pure inflammation characteristics, can cause improvement in the cetane number of B30 thus becoming comparable to fossil diesel. Only a fair increase in the BSFC of B30+10%E blend has been observed due to a significant decrease in the heating value and viscosity of fuel.

The temperature of exhaust gases slightly decreased at higher alcohol concentrations due to the high evaporative heat of ethanol taking off heat from combustion space.

Exhaust gas emissions for oxygenated fuel blends. The results of the evaluation of the selected engine emission parameters are demonstrated in the graphs depending on the emission parameter of alcohol concentration. All parameters are calculated under standard atmospheric conditions.

Particulate emissions from the combustion of fossil diesel contain two major fractions (Molero de Blass 1998):

1. Material arising from the organic content of fuel and its failure to complete the burn-out process:
 - unburned hydrocarbons (*smoke*);
 - particulates formed via gas phase combustion or pyrolysis (*soot*);
 - cenospheres produced from cracked fuel or carbon along with ash (*coke*).
2. Material from the inorganic content of fuel: *ash*.

The results of PM emissions differ widely depending on the tested fuels, cycles, engines and exhaust gas aftertreatment systems used (Mittelbach and Remschmidt 2004). A decrease in carbon soot emissions of the engine fuelled with bio-based diesel blends is explained by the oxygen content of fuel (see Fig. 6).

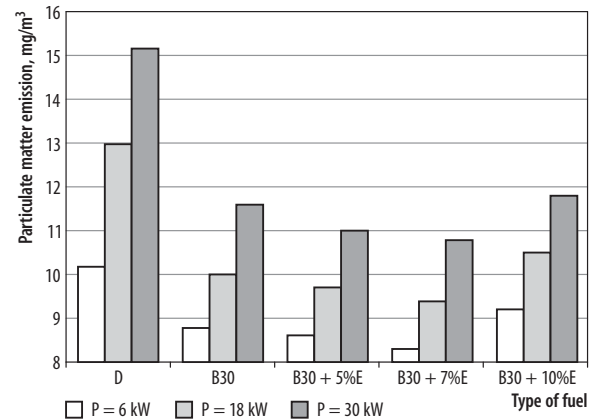

Fig. 6. Comparison of PM emission dependence on the type of fuel and engine load ($n = 1600 \text{ min}^{-1}$)

It enhances oxygen availability within the cylinder during combustion and thus reduces the pyrolysis of the unburned and partly burnt compounds which would lead to the formation of soot. In general, the total PM mass of B30 combustion was lower than that of conventional diesel under all engine operating conditions. The combustion of oxygenated biodiesel (B30) improves engine-out particulate matter emission. Blending diesel fuel with rapeseed methyl ester could unlock potential performance synergies in the fuel properties (e.g. O_2 content in RME and higher cetane number) of such blends and benefit engine performance and emissions. However, a further increase in the biodiesel ratio in diesel fuel becomes unacceptable due to the fact that engine modifications are required. The use of ethanol to enrich biodiesel blends has, therefore, received considerable attention with particular emphasis on adapting fuel to meet the requirements of the engine. It is mostly used as a fuel additive. The results indicate that the PM emission of the engine operating on 5% and 7% ethanol–B30 blends significantly improved when compared to pure diesel. However, in the case of 10% ethanol–B30 blend, a quantity of particulate matter in exhaust gases remained more-or-less in the range of pure B30 with a tendency to increase.

The engines fuelled with bio-based combustible mixtures distinguish for their increased emissions of nitrogen oxides (see Fig. 7). The major source of NO_x production from nitrogen-bearing fuels such as biodiesel and ethanol is the conversion of fuel bound nitrogen to NO_x during combustion. Although the complete mechanism is not fully understood, there is a primary path of formation involving the oxidation of volatile nitrogen species during the initial stages of combustion. During release and prior to the oxidation of volatiles, nitrogen

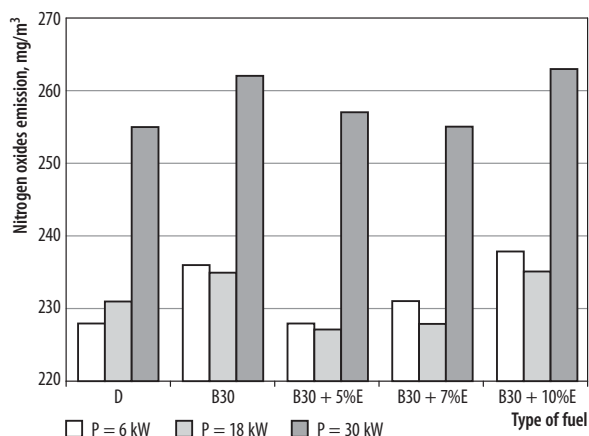

Fig. 7. Comparison of the dependence of nitrogen oxides emission on the type of fuel and engine load ($n = 1600 \text{ min}^{-1}$)

reacts to form several intermediaries oxidized into NO at a further stage. If the volatiles evolve into a reducing atmosphere, the evolved nitrogen can readily be made to form nitrogen gas rather than NO_x .

Under test conditions reported herein, we have demonstrated that B30+5%E and B30+7%E blends have lower NO_x emissions than pure B30 blend. Additionally, for the tested engine used in this study, small doses of ethanol did not increase NO_x emission levels above those measured for fossil diesel which indicated that under conditions set out in our case, D–RME–E biodiesel was NO_x neutral. This decrease in NO_x is significant because it eliminates an increase in NO_x emissions observed when a 30% blend of rapeseed methyl ester is substituted for pure diesel. This suggests that by judiciously blending biofuels from different feedstock, NO_x -neutral biodiesel fuel can be obtained.

Carbon monoxide emission from the diesel engine with different blends is shown in Fig. 8. Carbon monoxide gas is a toxic byproduct of all hydrocarbon combustion that is also reduced by increasing the oxygen content of fuel. More complete oxidation of fuel results in more complete combustion of carbon dioxide rather than in leading to the formation of carbon monoxide. CO emission has increased along with an increase in load conditions for diesel and biodiesel blended fuels.

Fig. 8 shows differences in the levels of the emission of carbon monoxide emitted by the tractor power unit between two engine characteristics: at the speed of maximum torque (1600 min^{-1}) as well as at low and average loads. These differences fall within the range from 30% to 35% and are the least significant for B30 fuel having 7% (v/v) of ethanol content. In general, an addition of rapeseed methyl ester (RME) to pure fossil diesel causes a decrease in the emission levels of carbon monoxide dramatically. Must to admit, the emission of carbon monoxide diminishes when operating a high-speed diesel engine under overloaded mode conditions.

The findings of reducing CO and hydrocarbon (HC) emissions of biodiesel fuels are attributed to the oxygen content of rapeseed methyl ester amounting to

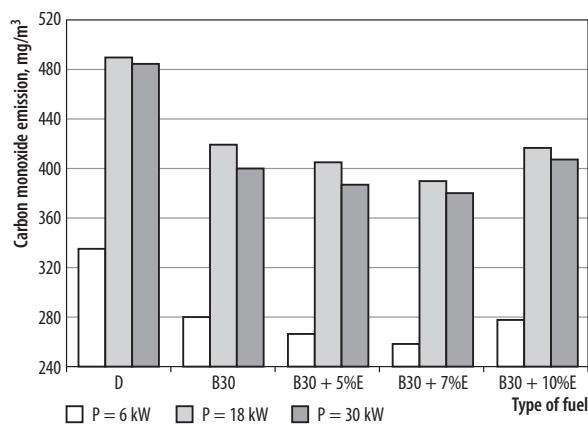

Fig. 8. Comparison of the dependence of carbon monoxide emission on the type of fuel and engine load ($n = 1600 \text{ min}^{-1}$)

about 11% which leads to more complete combustion. As oxygenated seed-corn hydrocarbon, biodiesel itself burns cleanly as well as improves the efficiency of combustion in the blends with diesel fuel. In a 30% biodiesel blend, there will be a noticeable change in the odor and smoke of exhaust.

Unburnt hydrocarbons generally stem from the regions in the combustion chamber in which fuel is diluted with air to such a high extent that the mixture fails the process of complete combustion (Mittelbach and Remschmidt 2004). The concentration of unburnt HC emitted from these over-lean regions depends on the amount of fuel injected during the ignition delay period that is shorter for RME due its higher cetane number, and therefore hydrocarbon emissions decrease correspondingly (see Fig. 9).

Not appreciating a type of fuel used for the diesel engine, the fact was under the spotlight that hydrocarbon emission values peaked at low load (6 kW) mode as well as those emitted from the average or high loads were considerably reduced. While using a B30+7%E blend, the emissions of hydrocarbons (HC) were significantly reduced compared to test results on baseline

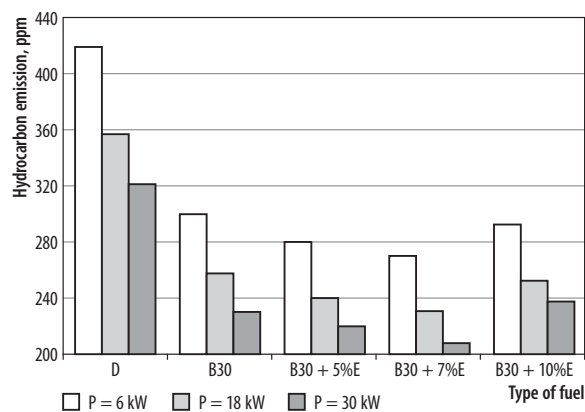

Fig. 9. Comparison of the dependence of hydrocarbon emission on the type of fuel and engine load ($n = 1600 \text{ min}^{-1}$)

diesel fuel. A combustible mixture on the basis of D–RME–E blend provided better fuel spray penetration leading to the efficient combustion process. Increasing a share of dehydrated ethyl alcohol to 10% (v/v) in B30 blend affects rising up the quantity of hydrocarbon compounds in exhaust gases. This trend was perhaps due to the different nature of oxygenates distinguished for severely different physical–chemical characteristics laying special emphasis on the sufficient and spare amount of ethanol needed to dissolve glycerol residues in biodiesel.

The chemical behaviour of the oxygenated fuel blends. Biodiesel solvent properties cause the degradation of natural rubber hoses and gaskets. Generally, B30 blend and the blends below do not encounter this problem. This is typically only an issue in diesel engine vehicles made before 1993. At that time, fuel lines were commonly made from rubber. Solvent properties in biodiesel disintegrate rubber and sometimes cause leaks in the fuel lines. In these vehicles, biodiesel can still be used but the fuel lines must be monitored for leakage and possibly replaced with vitron fuel lines or other synthetic fuel lines. The current diesel vehicles can run on the proposed D–RME–E biodiesel without any modifications.

Due to the solvent properties of biodiesel, the impurities and deposits of paraffin–based buildup from fossil diesel fuel previously used in the tank may release from edges and flow through the fuel lines to the fuel filter. These deposits can then plug the fuel filter which is generally problematic only when using pure biodiesel. The fuel filter can be plugged only when using a fuel tank that previously contained fossil diesel fuel. To keep this from happening, it is recommended that the fuel filter be replaced before the engine is converted to biodiesel and after a few hundred motor–hours of using biodiesel until the fuel system is cleaned of the deposits left from fossil diesel (Raslavičius and Bazaras 2009). To sum up, biodiesel acts as a solvent for cleaning injectors, fuel pump, fuel tank and fuel lines from contaminants fossil diesel leaves.

4. Conclusions

The above discussion shows that both biodiesel and dehydrated ethyl alcohol can have a considerable influence on fuel properties such as cetane number with relation to combustion and exhaust emissions. It therefore appears a reasonable concept of enriching certain fatty ester and fossil diesel blends with ethanol having desirable properties in order to amend the exploitation characteristics of the whole fuel. In conclusion, the following points can be taken into account:

1. During stand experiments on the unmodified high–speed diesel engine D 144 (a combustion chamber consists of a dished piston), oxygenated blend composition and engine load characteristics were estimated to endeavour to the usefulness of mixing two kinds of bio–based fuels acting together as an improver of combustible compound characteristics and leading to the bigger volumes of conventional diesel to be replaced by biofuels at the same time.

2. Using 5–7% (v/v) of ethanol additives to B30 compound ensures the engine fuel consumption rates close to those of pure mineral diesel thus avoiding BSFC increment biodiesel blends are famous for.
3. Biodiesel fuel admixed with 10% of ethanol (v/v) determines higher BSFC rates and increased exhaust emission of hazardous compounds comparing to the analogically established parameters of B30.
4. To evaluate the pollutant emission of heavy duty transport means for agricultural purpose, a high load (30 kW) engine mode was selected to discuss reasoning that peculiar exploitation characteristic is dominant. Two types of the oxygenated blends (B30 and B30+7%E) were selected to demonstrate an impact of the oxygenated additives (in particular – ethanol) on exhaust emission (fossil diesel emission accepted equal to 100%). Hereby, B30: PM (–23%), NO_x (+3%), CO (–16.5%), HC (–28%). And for B30+7%E: PM (–29%), NO_x (neutral to D), CO (–21.5%), HC (–35.5%).

References

- Al-Hasan, M. I.; Al-Momany, M. 2008. The effect of iso–butanol–diesel blends on engine performance, *Transport* 23(4): 306–310. doi:10.3846/1648-4142.2008.23.306-310
- Butkus, A.; Pukalskas, S.; Bogdanovičius, Z. 2007. The influence of turpentine additive on the ecological parameters of diesel engines, *Transport* 22(2): 80–82.
- Directive 2003/30/EC of the European Parliament and of the Council of 8 May 2003 on the *Promotion of the Use of Biofuels or Other Renewable Fuels for Transport*. Available from Internet: <http://ec.europa.eu/energy/res/legislation/doc/biofuels/en_final.pdf>.
- EN 50081–1:1992. Electromagnetic compatibility – Generic emission standard – Part 1: Residential, commercial and light industry.
- Hansen, A. C.; Hornbaker, R. H.; Zhang, Q.; Lyne, P. W. L. 2001. On-farm evaluation of diesel fuel oxygenated with ethanol, *American Society of Agricultural and Biological Engineers, Paper No 016173*.
- ISO 4788:2005. Laboratory glassware – Graduated measuring cylinders.
- Kuprys, A.; Kugelevičius, J. 2009. Possibilities of using liquefied oil gas in transport, *Transport* 24(1): 48–53. doi:10.3846/1648-4142.2009.24.48-53
- Kwanchareon, P.; Luengnaruemitchai, A.; Jai-In, S. 2007. Solubility of a diesel–biodiesel–ethanol blend, its fuel properties, and its emission characteristics from diesel engine, *Fuel* 86(7–8): 1053–1061. doi:10.1016/j.fuel.2006.09.034
- Labeckas, G. 2005. *Aplinkai žalingos deginių emisijos mažinimas tobulinant dyzelinių variklių darbo procesą*. Habilitacijos procedūrai teikiamų mokslo darbų apžvalga: technologijos mokslai T000, aplinkos inžinerija ir kraštotvarka (04T) [Reduction of environmentally harmful exhaust emissions by improving the performance process of diesel engines. Summary of the review of scientific works presented for Dr Habil procedure: technological sciences T000, environmental engineering and landscape management (04T)]. Lithuanian university of agriculture. 34 p. (in Lithuanian).
- Lebedevas, S.; Lebedeva, G. 2009. The problems of using alcohol biofuel mixtures in the Lithuanian transport system, *Transport* 24(1): 58–65. doi:10.3846/1648-4142.2009.24.58-65

- Lebedevas, S.; Lebedeva, G.; Makarevičienė, V.; Janulis, P.; Sendžikienė, E. 2009. Usage of fuel mixtures containing ethanol and rapeseed oil methyl esters in a diesel engine, *Energy & Fuels* 23(1): 217–223. doi:10.1021/ef800512z
- Lebedevas, S.; Vaicekuskas, A.; Suškov, P. 2007. Presumptions of effective operation of diesel engines running on RME biodiesel. Research on kinetics of combustion of RME biodiesel, *Transport* 22(2): 126–133.
- Lingaitis, L. P.; Pukalskas, S. 2008a. Ecological aspects of using biological diesel oil in railway transport, *Transport* 23(2): 138–143. doi:10.3846/1648-4142.2008.23.138-143
- Lingaitis, L. P.; Pukalskas, S. 2008b. The economic effect of using biological diesel oil on railway transport, *Transport* 23(4): 287–290. doi:10.3846/1648-4142.2008.23.287-290
- Liubarskis, V.; Kraujalis, A.; Raslavičius, L., et al. 2002. *Paruošti biodyzelino naudojimo reglamentą nesertifikuotiems traktoriams, užtikrinant jų saugą, eksploataciją ir mažinant gamtos taršą*. Tarpinė darbo programos „Žemės ūkio produktų gamyba ne maisto reikmėms“, ataskaita, patvirtinta LŽŪI instituto tarybos Ekspertų komisijos specializuotoje grupėje. Recenzentas dr. B. Baranauskas [To prepare a regulation concerning biodiesel usage for fuelling uncertified tractors, securing their safety, exploitation and reducing environment pollution. Interim report on the research program 'Production of the agricultural products for the non-food purposes', accepted by the Council of experts of LIAE. Copyreader: dr. B. Baranauskas]. Institute of agricultural engineering Lithuanian university of agriculture (in Lithuanian).
- LST EN 15376:2008/P:2009. Automobiliniai degalai. Etanolis kaip benzino kompaundavimo komponentas. Reikalavimai ir tyrimo metodai [Automotive fuels – Ethanol as a blending component for petrol – Requirements and test methods].
- LST EN 14214:2009. Automobiliniai degalai. Riebalų rūgščių metilesteriai (RRME), skirti dyzeliniams varikliams. Reikalavimai ir tyrimo metodai [Automotive fuels – Fatty acid methyl esters (FAME) for diesel engines – Requirements and test methods].
- LST EN 590:2004-11. Automobiliniai degalai. Dyzelinas. Reikalavimai ir tyrimų metodai [Automotive fuels. Diesel. Requirements and test methods].
- Matijošius, J.; Sokolovskij, E. 2009. Research into the quality of fuels and their biocomponents, *Transport* 24(3): 212–217. doi:10.3846/1648-4142.2009.24.212-217
- Mittelbach, M.; Remschmidt, C. 2004. *Biodiesel: a Comprehensive Handbook*. Graz, Austria. 330 p.
- Molero de Blass, L. J. 1998. *Pollutant formation and interaction in the combustion of heavy liquid fuels*. A thesis submitted in fulfilment of the requirements for the degree of Doctor of Philosophy of the University of London. 266 p. Available from Internet: <www.molero.free-online.co.uk/thesis.pdf>.
- Pikūnas, A.; Pukalskas, S.; Bureika, G.; Grabys, J. 2006. Investigation of efficiency of consuming ethanol of diesel engine, *Journal of KONES* 13(2): 381–386. Available from Internet: <www.ilot.edu.pl/KONES/2006/02/39.pdf>.
- Polák, M. 2004. Ethanol enriched biodiesel as a fuel for compression ignition engines, *Research in Agricultural Engineering* 50(3): 107–111.
- Pukalskas, S.; Bogdanovičius, Z.; Sendžikienė, E.; Makarevičienė, V.; Janulis, P. 2009. The mixture of biobutanol and petrol for Otto engines, *Transport* 24(4): 301–307. doi:10.3846/1648-4142.2009.24.301-30
- Raslavičius, L. 2009. *Trikomponenčio degaus mišinio taikymo dyzeliniuose varikliuose tyrimai*. Daktaro disertacija: technologijos mokslai T000, transporto inžinerija (03T). [Research into three-component combustible mixture application for fuelling diesel engines. PhD Thesis: technological sciences T000, transport engineering (03T). Scientific consultant Prof. PhD Ž. Bazaras], Kaunas University of Technology, 121 p. (in Lithuanian).
- Raslavičius, L.; Bazaras, Ž. 2009a. Oxygenated diesel fuels: physical-chemical properties and exploitation characteristics, in *Intelligent Technologies in Logistics and Mechatronics Systems (ITELMS) – 2009: Proceedings of the 4th International Conference*, 4–5 June, 2009, Panevėžys, Lithuania, 17–20.
- Raslavičius, L.; Bazaras, Ž. 2009b. The analysis of the motor characteristics of D–RME–E fuel blend during onfield tests, *Transport* 24(3): 187–191. doi:10.3846/1648-4142.2009.24.187-191
- Raslavičius, L.; Markšaitis, D. 2007. Research into three-component biodiesel fuels combustion process using a single droplet technique, *Transport* 22(4): 312–315.
- Shi, X.; Pang, X.; Mu, Y.; He, H.; Shuai, S.; Wang, J.; Chen, H.; Li, R. 2006. Emission reduction potential of using ethanol-biodiesel-diesel fuel blend on heavy-duty diesel engine, *Atmospheric Environment* 40(14): 2567–2574. doi:10.1016/j.atmosenv.2005.12.026
- Thompson, J. C.; Peterson, C. L.; Reece, D. L.; Beck, S. M. 1998. Two-year storage study with methyl and ethyl esters of rapeseed, *Transactions of the ASAE* 41(4): 931–939.
- Török, Á. 2009. Theoretical estimation of the environmental impact of biofuel mixtures, *Transport* 24(1): 26–29. doi:10.3846/1648-4142.2009.24.26-29
- Van Gerpen, J. 1996. Cetane number testing of biodiesel, in *Liquid Fuel and Industrial Products from Renewable Resources: Proceedings of the 1996 Third Liquid Fuel Conference*, 15–17 September 1996, 197–206.
- Yao, C. D.; Zhang, Z. H.; Xu, Y. L.; Huang, Y. 2008. Experimental investigation of effects of bio-additives on fuel economy of the gasoline engine, *Science in China Series E: Technological Sciences* 51(8): 1177–1185. doi:10.1007/s11431-008-0170-1